



### **Evaporative Coolers**



**Raise Your Productivity  
and Keep Your Technicians  
Cool and Comfortable**

**See Page 10**



**NEW Rechargeable LED  
Work Lights**

**See Page 63**



**Pedestal,  
Floor and  
Wall Mount  
Fans**

**See Page 10**





The AutoZone® Tool and Equipment Team is here to ensure our customers are always satisfied. As our customer, you can expect fast, personalized and professional service. Our customer service associates have over 200 years of combined experience in the tool and equipment industry.

**Call AutoZone® Tool & Equipment at 901-300-4878 for Questions Concerning:**

- Equipment Selection
- Product Delivery
- Service After the Sale
- Product Availability
- Technical Support
- Ordering Capital Equipment

**Call Your AutoZone® Commercial Sales Manager or Go to AutoZonePro.com**

- To Place Orders for Parts, Tools and Equipment
- For Questions Related to Parts and Vehicle Accessories
- For Commercial Credit, Lease or Financing Information

Scan This QR Code to Link to the Digital AutoZone Tool & Equipment Catalog on AutoZonePro.com



Businesses can take advantage of IRS S-179 tax credits on equipment purchases. Contact your CPA for details.

**FREE OVERNIGHT SHIPPING**



Free overnight shipping available to continental U.S. for qualifying orders of 70 lb. or less. Free overnight shipping excludes: liftgate fees, residential delivery, non-network carriers, and certain freight intensive items that are shipped FOB.

**IMPORTANT INFORMATION ABOUT RECEIVING YOUR FREIGHT ORDER**

The freight company will call 24 hours prior to delivery. It is important to take or return their calls to schedule delivery. Most items are shipped freight prepaid. Limited access, residential, carrier surcharges, redelivery and storage fees are not included.

**OFFLOADING? Do you need:**



- Items shipped via flatbed and most lifts will require a forklift.
- Palletized items including most capital equipment and tool storage require a liftgate or forklift.
- Drivers will not allow you to break down pallets and offload by hand.
- Inside delivery is not available. Product will be dropped as close as safely possible. Make sure your location is accessible to the truck and driver.
- DO NOT SIGN until you have inspected the freight and confirmed carton/pallet count.
- Refuse shipment and/or notate any discrepancies or possible hidden damage on the bill of lading.
- DO NOT ACCEPT OR SIGN FOR DAMAGED ITEMS. Accepting and signing for a damaged or short shipment without notation releases the carrier and distributor from any claim or responsibility.
- Contact us at 901-300-4878 immediately with any questions or problems with delivery.
- For hidden minor or cosmetic damage, we may at our discretion, choose to send replacement parts.

**ASK BEFORE YOU RETURN**

Many of the Tool and Equipment products are covered by the manufacturer's warranty and will be serviced and repaired in the field.

**Note: Most manufacturers require you to register your products with them before receiving support or service.**

**IF YOU HAVE QUESTIONS ABOUT WARRANTY OR RETURNS CALL 901-300-4878.**

**AUTOZONE® STORE MANAGERS AND COMMERCIAL SALES MANAGERS**

**Call Your Tool & Equipment Team at 901-300-4878 for Questions Regarding:**

- Product Ordering and Availability
- Assisting Customers with Price Quotes
- Service After the Sale
- Help with Outside Buy/EPO Orders

To place orders or for pricing contact your AutoZone® Commercial Sales Manager.  
For product information, availability and product support, **call 901-300-4878.**

## TOOLS AND EQUIPMENT IN THIS ISSUE:

Advanced Driver Systems (ADAS) . . . . . 29	Engine Service . . . . . 53-57	Key Machines . . . . . 126	Shop Supplies . . . . . 142-145
Air Compressors . . . . . 70-71	Engine Stands & Cranes . . . . . 84-85	Lighting & Flashlights . . . . . 63-65	Specialty Tools . . . . . 31, 46-52, 121-122
Air Conditioning . . . . . 14-24, 120	Evaporative Coolers . . . . . 10-11, 97	Motorcycle Lifts . . . . . 95	Surface Prep . . . . . 73, 77
Air Hoses & Reels . . . . . 76	EV Tools . . . . . 31	Oil Change . . . . . 38-42, 121-122	Technician Sets . . . . . 37, 80
Air Tools & Accessories . . . . . 72-77	Exhaust Tubing Bender . . . . . 126	Paint & Body . . . . . 130	Thread Repair . . . . . 140-141
Alignment . . . . . 29, 86-89	Fans . . . . . 10, 12	Parts Washers . . . . . 124-125	Tire Service . . . . . 90, 94, 97-108, 121
Automotive Lifts . . . . . 90-96, 122	Fluid Handling . . . . . 34-37	Power Tools & Accessories . . . . . 78-80	Tool Organization . . . . . 118-119
Battery Service . . . . . 9, 66-69	Generators . . . . . 71, 127	Pressure Washers . . . . . 127	Tool Storage . . . . . 8, 114-117
Brake Lathes . . . . . 109	Gloves . . . . . 129, 147	Pullers . . . . . 20, 47-49, 52-55, 59-62, 66, 113, 121, 123, 130	Torque Wrenches . . . . . 50, 108
Brake Service . . . . . 109-113	Grease Guns . . . . . 33	Ratchets . . . . . 133-134	TPMS Tools . . . . . 102-103
Chassis & Suspension . . . . . 58-62	Hand Tools . . . . . 5-8, 31, 131-139	Regulators, Filters, Drains . . . . . 71	Tubing . . . . . 76
Cooling System . . . . . 43-45, 120	Hardware Kits . . . . . 23-24, 46, 145	Rivet Tools . . . . . 51	Vacuum Pumps . . . . . 16-17
Creepers & Seats . . . . . 143-144	Heating & Cooling . . . . . 10-13	Safety Supplies . . . . . 146-147	Welding & Cutting . . . . . 128-129
Diagnostics . . . . . 25-32, 69, 102-103, 120, 144	Heavy Duty . . . . . 120-122	Scan Tools . . . . . 25-26, 28, 120	Wheel Weights . . . . . 106-107
Disconnect Tools . . . . . 46	Inflators . . . . . 74, 103	Shop Equipment . . . . . 123-127	Wrenches . . . . . 131
Drill Bits & Extractor Sets . . . . . 140-141	Jacks & Hydraulics . . . . . 9, 81-85, 122	Shop Presses . . . . . 123	
	Jump Starters . . . . . 9, 67		

## BRANDS IN THIS ISSUE:

ABAC . . . . . 70-71	CTA . . . . . 41, 53	Livernois . . . . . 57	Shark . . . . . 39, 77-78, 80, 96, 104, 110, 124, 129
Access Tools . . . . . 51	Cutting Edge . . . . . 85	Mahle . . . . . 14, 16, 37, 45	Sheffield . . . . . 117, 138
Air Movement Solutions . . . . . 12	Duralast . . . . . 5-9	Manatec . . . . . 101	Slip-N-Grip . . . . . 142
AirSept . . . . . 24, 46	Ecotechnics . . . . . 15-16	Marson . . . . . 51	Solar . . . . . 67
ALLDATA . . . . . 25	Energy Logic . . . . . 13	Mastercool . . . . . 11, 14, 16-24, 27, 43, 46, 112, 120	SRI . . . . . 124-125
Allstart . . . . . 67	FIX-A-THRED . . . . . 140	MaxJax . . . . . 95	Steck . . . . . 48, 51, 84, 143
American Forge & Foundry . . . . . 83-85, 122	FJC Inc. . . . . 18, 24	Mi-T-M . . . . . 71, 127	Streamlight . . . . . 65
Arrow Pneumatics . . . . . 71	Flexzilla . . . . . 65, 76	Midtronics . . . . . 66	SUNEX . . . . . 75
Associated . . . . . 66-69	Forney Industries . . . . . 128-129	Mighty Seven/M7 . . . . . 72-74	Sunfire . . . . . 13
Astro . . . . . 74, 103	Forward Lift . . . . . 89, 92	Mityvac . . . . . 32, 34-35, 111	SUR&R . . . . . 31, 40, 46, 145
ATD Tools . . . . . 65, 130	GearWrench . . . . . 131, 144	MotorVac . . . . . 31, 37, 113	Sure Shot . . . . . 113
ATEQ . . . . . 102	GreatLite . . . . . 63, 65	OEMTOOLS . . . . . 10, 16-20, 22-24, 27-28, 33-64, 66, 69, 72-85, 87, 95, 102-108, 110-113, 116-119, 121-126, 128-144, 146	SureBilt . . . . . 42
Atlas Automotive . . . . . 94	GreatNeck . . . . . 64, 132, 138-139	ONE-Direct Sensors . . . . . 102	Sylvania . . . . . 65
Autel . . . . . 26, 28-29, 69, 103	H&S Autoshot . . . . . 128, 130	Phoenix Systems . . . . . 111, 113	Symtech . . . . . 126
Balcrank . . . . . 37, 39	Hardware Machinery . . . . . 23, 51, 145	Portacool . . . . . 11	TEXA . . . . . 15, 29, 120
Baseline . . . . . 99	Hofmann . . . . . 86-87, 89, 98, 101	Power Probe . . . . . 30, 49	Thexton . . . . . 44
BelAire . . . . . 71	Homak . . . . . 114-115, 117	Pro-Cut . . . . . 109	Titan . . . . . 31
BendPak . . . . . 85, 89, 93-96, 122, 126	Hunter Fans . . . . . 12	QSP . . . . . 59, 87	TMR/The Main Resource . . . . . 104
Branick . . . . . 59, 103, 105	Ilco . . . . . 126	Quality Lifts . . . . . 91	TOPDON . . . . . 26, 30, 66-68
BRM . . . . . 54, 113, 124	Ingersoll Rand . . . . . 72-74	QuickJack Lifts . . . . . 95	Traxion . . . . . 143
Cal-Van . . . . . 46, 49, 55, 105, 130, 140-141	Innova . . . . . 32	Ranger . . . . . 39, 83-84, 97, 99, 101, 109, 125	Tuxedo . . . . . 90
CEMB . . . . . 88, 99-100	IPC . . . . . 127	Rapidair . . . . . 76	UView . . . . . 21-22, 45
Central Tools . . . . . 50, 108, 110	Jackson . . . . . 129, 146	Redline . . . . . 27	Viking . . . . . 82, 117
Challenger Lifts . . . . . 85, 89, 91, 95-96, 122	John Dow . . . . . 13, 36, 46, 142, 145	Robinair . . . . . 15-16	VIM Tools . . . . . 111
Champion Air Compressors . . . . . 71	Ken-Tool . . . . . 121, 125	Rotary . . . . . 88, 92, 98, 121	Water Works . . . . . 125
Champion Power Equipment . . . . . 127	Knipex . . . . . 31	SAS . . . . . 146-147	Wiha Tools . . . . . 31
Coats . . . . . 88-89, 91, 98, 100, 104, 121	Lanair . . . . . 13	Schrader . . . . . 106	Xtra Seal . . . . . 108
CoolBoss . . . . . 11, 97	Lang . . . . . 31, 112		
CPS . . . . . 14, 16-17, 23, 120	Lincoln . . . . . 33, 36, 38, 42, 76, 121, 124		
Crushproof Tubing Co. . . . . 12	Lisle . . . . . 39-40, 42, 46, 48, 53-54, 56-57, 60-61, 105, 112, 140-141, 146		

Prices subject to change without notice. Prices do not include applicable taxes, vehicles, tires, rims, installation or optional equipment as shown. Please do not return purchases to the store. For information regarding warranty, repair, or any questions or concerns, call 901-300-4878.

## CHECK IT OUT! OVER 70 **NEW** PRODUCTS



- AC Recovery Hose Sets.....19-20
- 500 CC Extraction and Filling Pump.....34
- Dual Mode Work Lights and Flashlights.....63
- Heavy Duty Floor Jacks.....81
- 1500 Lb. Wheel Dollies.....82
- Double-Scissor Lifting Table Cart.....85
- 4 Drawer Rolling Tool Cart.....116
- Shop Presses and Accessories.....123
- Spark Plug Thread Repair Kit.....140
- 8 Pc. Tap Socket Set.....141
- Adjustable Shop Stool.....144



EV Tools.....31



Gear Oil Dispensers and Assembly.....35



Duel Fuel Powered Generator.....127



Welders, Torch Kits and Accessories...128-129



Raven Patriot Nitrile Gloves.....147

### 30 Ton Super Duty Air/Manual Shop Press

SKU 1525570  
29001

**1,399<sup>99</sup>**

Polycarbonate Protective Guard Shield for Maximum Safety Against Shrapnel and Debris

See More **SHOP EQUIPMENT** on Pages 123-127



### 8 Piece Press Accessory Kit

SKU 1525566  
29002

**189<sup>99</sup>**

- Includes: 2 Press Plates, 5 Punches, a Quick Change Adapter Chuck and a Bearing Shield



### LED Light with Auto Sensor

SKU 1525569  
32122

**39<sup>99</sup>**

- Auto Sensor Automatically Turns Light Off When Sensor is Covered

LIGHTWEIGHT  
**5.2 oz.**

AUTO ON/OFF



#### LUMENS

**100**  
LUMENS  
WORK LIGHT

**80**  
LUMENS  
LED LOW

**600**  
LUMENS  
LED MEDIUM

**1200**  
LUMENS  
LED HIGH

#### RUNTIMES

**12 hrs**  
WORK LIGHT

**10 hrs**  
LED LOW

**5.5 hrs**  
LED MEDIUM

**1.5 hrs**  
LED HIGH

See More **LIGHTING** on Pages 63-65

### Adjustable Hydraulic Shop Stool

SKU 751712  
24912

**149<sup>99</sup>**

Adjustable Height: 28" to 32-1/2"



Leg Color May Vary



360° Rotating Seat

See More **SHOP SUPPLIES** on Pages 142-145

### 190 MP MIG Stick TIG Welder

SKU OUTSIDE BUY/EPO  
FRN323

**1,299<sup>99</sup>**

- 4-in-1 Multi-Process Machine (MIG/Stick/Flux-Core/DC TIG, TIG Torch Not Included)
- Includes: 6' Power Cable, 8' Stick Electrode Holder, 8' Ground Cable and Clamp, 120V-240V Adapter Cord, 6' Gas Hose, 10' MIG Gun, Gas Regulator, Spare .030" and .035" Tips



See More **WELDING** on Pages 128-129

### 4 Ton Hydraulic Service Jack

SKU 1525558  
29003

**349<sup>99</sup>**

- Min. Height: 4.33"
- Max. Height: 20.28"



**PADDED HANDLE**

### 2 Ton Off-Road Jack

SKU 1525571  
29004

**299<sup>99</sup>**

- Max. Height: without Extension: 17-15/16", with Extension Stage: 24-3/16"



**PADDED HANDLE**

### 660 Lb. Double-Scissor Lifting Table Cart

SKU 1525568  
24789

**699<sup>99</sup>**

- Double Scissor Mechanism Raises the Table from 13.8" to 50.6"
- Large 32" x 20" Platform Fits a Wide Range of Items



See More **JACKS & HYDRAULICS** on Pages 81-85

### 1500 Lb. Wheel Dollies Set

SKU 814384  
24858

**119<sup>99</sup>**

- 4 Swivel Nylon Casters Give Mobility in All Directions. Roll Smoothly and are Safe for Epoxy Floors
- HD Steel Plate Construction for a Long Life



## Duralast® NEW TOOLS

### Duralast

**39PC 1/2" Drive Metric Impact Socket Set**  
SKU 1146660

**103<sup>49</sup>**



- Features sockets made of impact grade alloy steel for increased durability and a longer life
- The impact sockets are heat-treated for added strength and wear protection
- The durable black oxide finish is designed for impact use and provides corrosion resistance
- Features an off-corner loading design which puts force on the flats of fasteners for improved durability and reduced fastener rounding
- Set Includes: 9, 10, 11, 12, 13, 14, 15, 16, 17, 18, 19, 20, 21, 22, 23, 24, 26, 27, and 30mm sizes in standard and deep lengths

### Duralast

**21PC Z-Driver Set**  
SKU 1413288

**17<sup>99</sup>**



- Features a swivel Z driver with 1/4" hex and 1/4-in square drive ends
- The swivel Z driver has flex heads able to rotate 180 degrees for access in tight spaces, and can be used for driving both sockets and insert bits
- Sockets feature an off-corner loading design which puts force on the flats of fasteners for improved durability and reduced fastener rounding
- Set Includes: 1/4", 5/16", 3/8", 7/16", 1/2", 6mm, 7mm, 8mm, 10mm, 12mm, plus 10 insert bits
- Set is guaranteed for life

### Duralast

**5PC 1/2" Drive Torque Limiting Extension Set**  
SKU 1413265

**53<sup>99</sup>**



- Includes sizes covering between 65 ft-lbs and 140 ft-lbs
- Designed to limit the amount of torque applied to a fastener when used as intended with impact wrenches
- Made of impact grade alloy steel for increased durability and a longer life
- Heat-treated for added strength and wear protection
- Set Includes: 65 ft-lbs, 80 ft-lbs, 100 ft-lbs, 120 ft-lbs, and 140 ft-lbs

### Duralast

**5" Pocket Pry Bar 1/4"**  
SKU 1413351

**8<sup>99</sup>**



- Steel striking cap designed for hammer striking, with shanks that extend through the handle to the steel striking cap
- 5 inch design for access in tight spaces, and includes pocket clip for convenience
- Angled tip gives increased leverage and access to confined areas
- Black phosphate coating provides corrosion resistance
- Ergonomic dual material handle provides a secure, comfortable grip

## Duralast® MECHANIC'S TOOL SETS

### Duralast

#### 90PC EVA Mechanic's Tool Set

SKU 1382518

**64<sup>99</sup>**



- 1/4-in and 3/8-in drive mechanic's tool set
- EVA foam provides an easy and organized storage solution that can be placed directly into a toolbox
- Includes 100 position ratchets (1/4-in and 3/8-in drive)
- Sockets feature off-corner loading design to help prevent the rounding of fasteners

### Duralast

#### 9PC Tire Changing Kit

SKU 1382480

**99<sup>99</sup>**



- 1/2-in drive sockets, breaker bar, extension & torque wrench
- Torque wrench has range of 50 - 250 ft/lbs
- 12-point deep well sockets fit into wheel recesses and a 5 in. extension provides access for inset wheels or for use on vehicles with fender flares

### Duralast

#### 265PC Mechanic's Tool Set

SKU 1077624

**179<sup>99</sup>**



- 1/4-in, 3/8-in, and 1/2-in drive mechanic's tool set
- 6-point standard and deep sockets (1/4-in, 3/8-in drive) and 12-point standard sockets (1/2-in drive)
- Sockets feature off-corner loading design to help prevent the rounding of fasteners
- Alloy Steel sockets and drive tools heat treated for superior strength

### Duralast

#### 180PC Mechanic's Tool Set

SKU 52378

**119<sup>99</sup>**



- 1/4-in, 3/8-in, and 1/2-in drive mechanic's tool set
- 6-point standard and deep sockets (1/4-in, 3/8-in drive) and 12-point standard sockets (1/2-in drive)
- Sockets feature off-corner loading design to help prevent the rounding of fasteners
- Alloy Steel sockets and drive tools heat treated for superior strength

### Duralast

#### 90PC Mechanic's Tool Set

SKU 52377

**89<sup>99</sup>**



- 1/4-in and 3/8-in drive mechanic's tool set
- 6-point standard and deep sockets
- Sockets feature off-corner loading design to help prevent the rounding of fasteners
- Alloy Steel sockets and drive tools heat treated for superior strength

### Duralast

#### 60PC Mechanic's Tool Set

SKU 15881

**59<sup>99</sup>**



- 3/8-in drive mechanic's tool set
- 6-point standard and deep sockets
- Sockets feature off-corner loading design to help prevent the rounding of fasteners
- Alloy Steel sockets and drive tools heat treated for superior strength

### Duralast

#### 45PC Mechanic's Tool Set

SKU 15879

**39<sup>99</sup>**



- 1/4-in drive mechanic's tool set
- 6-point standard and deep sockets
- Sockets feature off-corner loading design to help prevent the rounding of fasteners
- Alloy Steel sockets and drive tools heat treated for superior strength
- Premium S2 steel bits for durability

## Duralast® BREAKER BARS



- Duralast Breaker bars feature a flexible drive tang that rotates 180 degrees for use at multiple angles
- Ideal for breaking free stuck fasteners
- Ergonomically designed handle provides a secure grip
- Alloy Steel heat treated for superior strength
- Professional, full polish chrome finish provides resistance to corrosion

### Duralast

#### 1/2" Drive Ratcheting Breaker Bar

SKU 1327044



**35<sup>99</sup>**

- Features a 45-tooth ratcheting head (with 8 degrees ratcheting arc)
- Includes reversing collar to change between tightening and loosening directions
- Flex head square drive rotates 180 degrees for access
- Forged Alloy Steel heat treated for superior durability and strength
- Chrome finish provides corrosion resistance and added durability

### Duralast

#### 1/2" Drive Breaker Bars



**26<sup>99</sup>**  
18 INCH  
SKU 914045

**28<sup>79</sup>**  
24 INCH  
SKU 914046

- Forged Alloy Steel heat treated for superior durability and strength
- Chamfered square drive lead-in helps provide easy placement of sockets onto drive
- Full polished chrome finish ratchet easily wipes clean of oil and dirt
- Chrome finish provides corrosion resistance and added durability

### Duralast

#### 3/8" Drive Breaker Bars



**16<sup>19</sup>**  
10 INCH  
SKU 565694

**23<sup>39</sup>**  
18 INCH  
SKU 565693

- Forged Alloy Steel heat treated for superior durability and strength
- Chamfered square drive lead-in helps provide easy placement of sockets onto drive
- Full polished chrome finish ratchet easily wipes clean of oil and dirt
- Chrome finish provides corrosion resistance and added durability

### Duralast

#### 1/2" Drive Extendable Breaker Bar, 11"-17"

SKU 582082



**26<sup>09</sup>**

- Breaker bar can collapse down to 10 inches and extend all the way to 15 inches to provide greater access and leverage for whatever obstacle a job throws your way
- Extendable handle provides greater access for hard to reach areas and greater leverage
- Forged Alloy Steel heat treated for superior durability and strength
- Chamfered square drive lead-in helps provide easy placement of sockets onto drive
- Full polished chrome finish ratchet easily wipes clean of oil and dirt

## Duralast® TOOL STORAGE

**Duralast**  
42 in. 4-Drawer  
Top Chest, Blue  
SKU 1354163

**359<sup>99</sup>**

- 21-gauge steel construction
- 100 lb. soft-close full-extension drawers with liners
- Built-in power strip (4 outlets & 2 USB ports)
- 7,668 cubic inches of storage
- 400 lb. total weight capacity
- Combine with 1354168 (sold separately)



- 21-gauge steel construction
- 100 lb. soft-close full-extension drawers with liners
- 5"x2" heavy-duty casters to support up to 1,200 lbs.
- 10,532 cubic inches of storage
- 800 lb. total weight capacity
- Combine with 1354163 (sold separately)

**42 in. 9-Drawer  
Tool Cabinet, Blue  
SKU 1354168**

**449<sup>99</sup>**

**Duralast**  
30 in. 5-Drawer  
Mechanic's Cart  
BLUE SKU 1354167  
BLACK SKU 1354164

**329<sup>99</sup>**

- High-capacity, full-extension ball bearing drawer slides
- 90-degree lid opening with dual gas struts
- 15,000 cubic inches of storage
- 700 lb. total weight capacity



**Duralast**  
30 in. 4-Drawer  
Technician Cart  
BLUE SKU 1354165  
BLACK SKU 1354166

**249<sup>99</sup>**

- High-capacity, full-extension ball bearing drawer slides
- 90-degree lid opening with dual gas struts
- 12,600 cubic inches of storage
- 580 lb. total weight capacity



## SPECIAL DEALS

**Duralast**

1/4", 3/8", 1/2" Drive  
**435PC Mechanic's Tool Set**  
SKU 1089589  
Storage NOT Included

**429<sup>99</sup>**



**\$1,850 Value**

- Features 237 Chrome Sockets, 51 Wrenches, 42 Impact Sockets, 6 ratchets & more!
- The most tools for your money, all guaranteed for life

**Duralast**

1/4", 3/8", 1/2" Drive  
**335PC Mechanic's Tool Set**  
SKU 1092684  
Storage NOT Included

**269<sup>99</sup>**



**\$1,350 Value**

- Features 210 Chrome Sockets, 41 Wrenches, 3 Ratchets & more!
- Professional Grade Tool Selection, All Guaranteed for Life

**Duralast**  
10PC 1/4", 3/8" Drive  
10MM Socket Set  
SKU 582151

**16<sup>99</sup>**



- The Duralast 10pc 10mm socket set takes the need of the 10mm socket, and provides a solution for any application
- Chamfered lead-ins help to provide fast and easy placement of sockets and accessories onto drive

**Duralast**  
9PC Triple  
Square Bit Set  
SKU 1077622

**19<sup>99</sup>**



- Cold formed Alloy Steel socket base and S2 tool steel bit heat treated for superior durability and strength
- Bit sockets attach to drive tools, such as ratchet or breaker bar, providing a long handle for leverage
- Full polished chrome finish socket easily wipes clean of oil and dirt

**Duralast**  
36PC Master Bit  
Socket Set  
SKU 569654

**44<sup>99</sup>**



- Cold formed Alloy Steel socket base and S2 tool steel bit heat treated for superior durability and strength
- Full polished chrome finish socket easily wipes clean of oil and dirt
- Bit sockets attach to drive tools, such as ratchet or breaker bar, providing a long handle for leverage



## Duralast® LIFT EQUIPMENT & BATTERY CHARGERS

**Duralast GOLD** 3 Ton Aluminum Floor Jack  
SKU 1276166



- Light weight design for easy mobility
- 3 ton capacity dual pump piston with universal release
- Slow descent release



FEATURE PRICE  
**249<sup>99</sup>**

**Duralast GOLD** 3-1/2 Ton Professional Foldable Garage Jack  
SKU 1276164



- 30" lift height with adapter
- Dual piston lift pump
- Slow descent release for controlled load lowering



FEATURE PRICE  
**229<sup>99</sup>**

**Duralast**  
2.5 Ton Jack & Stands Kit  
SKU 562996

**89<sup>99</sup>**

- 2.5 ton capacity
- 2.5 ton stands



**Duralast**  
3 Ton Dual Piston Jack  
SKU 847109

**149<sup>99</sup>**

- 3 ton capacity
- Dual piston pump with universal release
- High lift height



**Duralast**  
2.5 Ton Aluminum Steel Garage Jack  
SKU 979807

**149<sup>99</sup>**

- 2.5 ton capacity
- Aluminum design for lightweight
- Dual pump piston with universal release for controlled loads



**Duralast**  
6 Ton Jack Stands  
SKU 234799

**59<sup>99</sup>**

- Full welded heavy gauge steel base
- Large Cast iron ratchet pawls for secure locking
- Multiple height positions



**Duralast**  
250 Amp 12 Volt Battery Charger  
SKU 1277303

**149<sup>99</sup>**

- The DL-250D is compatible with 12-volt standard, lithium, AGM, gel, and deep-cycle batteries
- The 250-amp engine start is strong enough to jump start cars, SUVs, trucks, and boats
- Manual operation controlled by 135-minute timer and manual rate selection knob
- Built-in ammeter lets you monitor the complete charging process



**Duralast**  
Lithium Battery Booster/Jump Pack  
SKU 567656

**99<sup>99</sup>**

- Powerful 1200-amp jump start is strong enough for cars, trucks, motorcycles, boats, SUVs, and other large engines
- 150-PSI air compressor features a digital pressure gauge making it easy to inflate tires, toys, mattresses, and more
- The 2.4-amp USB port charges smartphones and other mobile devices two times faster than a standard USB charger"



# HEATING & COOLING

## Raise Productivity

Unique high efficiency propeller design is quiet and delivers airflow over long distances.

Keep your technicians cool and comfortable.



### Evaporative Coolers

**5300 CFM**  
SKU 213172 **799<sup>99</sup>**  
23969

- 1/3 HP 3 Speed Motor
- Water Capacity: 14.6 Gallons
- Cooling Area: 1,600 Sq. Ft.
- Dimensions: 45" x 17" x 28"
- Weight: 56 Lb.
- GFCI Plug for Safe Outdoor Use

**3100 CFM**  
SKU 213184 **599<sup>99</sup>**  
23968

- 1/5 HP 3 Speed Motor
- Water Capacity: 10.3 Gallons
- Cooling Area: 950 Sq. Ft.
- Dimensions: 37" x 17" x 25"
- Weight: 39 Lb.
- GFCI Plug for Safe Outdoor Use

### Replacement Media Sets

**For 23969/23977**  
**5300 CFM**  
SKU 1485036 **129<sup>99</sup>**  
HESCP610

**For 23968/23976**  
**3100 CFM**  
SKU 1485034 **89<sup>99</sup>**  
HESCP370



Customer Responsible For Offloading, Liftgate Service Available.

### Oscillating Wall Mount Fans

- Powerful 3-Speed Motor
- Easy to Assemble and Wall Mountable
- Oscillating Function Provides Effective Air Circulation



**24" Indoor Fan**  
SKU 592383 **199<sup>99</sup>**  
OEM24883

- CFM: 6500

**30" Indoor Fan**  
SKU 592385 **219<sup>99</sup>**  
OEM24884

- CFM: 9500

**24" Outdoor Fan**  
SKU 949553 **259<sup>99</sup>**  
OEM24893

- CFM: 6800
- IP44 Water Resistance Rating

**30" Outdoor Fan**  
SKU 949582 **299<sup>99</sup>**  
OEM24894

- CFM: 7200
- IP44 Water Resistance Rating

OSCILLATING



### Oscillating Pedestal Fans

- 5 Aluminum Blades
- 6' UL Listed Power Cord



**20"**  
SKU 688197 **134<sup>99</sup>**  
OEM24871

- CFM: 4500



**30"**  
SKU 592248 **249<sup>99</sup>**  
OEM24885

- CFM: 9500



### Floor Fan



#### 20" High Velocity Floor Fan

SKU 688200 **59<sup>99</sup>**  
OEM24870

- CFM: 4500
- Precision-Balanced Aluminum Fan Blades and Energy-Efficient Motor Optimize Airflow Output
- 3-Speed Motor Allows Operator to Control Airflow Volume
- 5' UL Listed Power Cord



TILT



### Barrel Fan



#### 42" Direct Drive Barrel Fan

SKU 344969 **449<sup>99</sup>**  
OEM24879

- CFM: 12,718
- 2-Speed, Direct Drive Motor Allows Control of Airflow Volume
- 3 Aerodynamic Aluminum Blades Produce Optimal Airflow Output



# HEATING & COOLING

TO ORDER, contact your Commercial Sales Manager or go to [AutoZonePro.com](http://AutoZonePro.com)

HEATING & COOLING

## PORTACOOOL

### PEAK COOLING, INTELLIGENT CONTROL

- Portacool APEX™ Series
- Setting the STANDARD for Auto Shop Cooling
- New HydroTek™ Evaporative Media – designed to MAXIMIZE cooling performance with less maintenance
- Control Your Comfort with COOLSYNC™ – Sync your Portacools to your smartphone for intelligent control
- Fan Speed
- Wind Direction
- Water Control
- Group Syncing
- Scheduling



PRCA05001A1

**Apex 500**  
SKU 1392317  
PRCA05001A1 **1,099<sup>99</sup>**

- Cooling: Up to 500 Sq. Ft.
- Velocity: 40 MPH
- Air Flow Reach: 55 Ft.
- Water: 13 Gal.

**Apex 700**  
SKU 1392315  
PRCA07001A1 **1,599<sup>99</sup>**

- Cooling: Up to 700 Sq. Ft.
- Velocity: 37 MPH
- Air Flow Reach: 60 Ft.
- Water: 22 Gal.



PRCA12001A1

**Apex 1200**  
SKU 1392332  
PRCA12001A1 **2,399<sup>99</sup>**

- Cooling: Up to 1200 Sq. Ft.
- Velocity: 25 MPH
- Air Flow Reach: 40 Ft.
- Water: 40 Gal.

**Apex 2000**  
SKU 1392329  
PRCA20001A1 **3,199<sup>99</sup>**

- Cooling: Up to 2000 Sq. Ft.
- Velocity: 28 MPH
- Air Flow Reach: 60 Ft.
- Water: 45 Gal.



PRCA65001A1

**Apex 4000**  
SKU 1392335  
PRCA40001A1 **3,799<sup>99</sup>**

- Cooling: Up to 4000 Sq. Ft.
- Velocity: 25 MPH
- Air Flow Reach: 50 Ft.
- Water: 55 Gal.

**Apex 6500**  
SKU 1392341  
PRCA65001A1 **4,999<sup>99</sup>**

- Cooling: Up to 6500 Sq. Ft.
- Velocity: 24 MPH
- Air Flow Reach: 40 Ft.
- Water: 66 Gal.

## Evaporative Coolers



- 80W 4000 Lumens Adjustable LED Floodlight
- Anion Negative Ion Air Purifier
- Low Level Shutoff
- Built-In Bluetooth® Audio Player and Speakers
- Wireless Remote Control

**CB-12L**  
SKU 1360694  
CLBCB-12SL **1,399<sup>99</sup>**

- Max. Airflow: 1,565 CFM
- Cooling Area: 650 sq. ft.
- Fan Diameter: 12"

**CB-16L**  
SKU 1275460  
CLBCB-16L **2,599<sup>99</sup>**

- Max. Airflow: 4,950 CFM
- Cooling Area: 1,125 Sq. Ft.
- Fan Diameter: 16"

**CB-36L**  
SKU 1275465  
CLBCB-36L **4,499<sup>99</sup>**

- Max. Airflow: 12,615 CFM
- Cooling Area: 3,125 Sq. Ft.
- Fan Diameter: 36"

**CB-14L**  
SKU 1400037  
CLBCB-14SL **1,649<sup>99</sup>**

- Max. Airflow: 2,300 CFM
- Cooling Area: 850 sq. ft.
- Fan Diameter: 14"

**CB-28L**  
SKU 1275461  
CLBCB-28L **3,499<sup>99</sup>**

- Max. Airflow: 9,020 CFM
- Cooling Area: 2,125 Sq. Ft.
- Fan Diameter: 28"



CLBCB-16L

We Offer the Full Line of Portacool and Cool Boss Evaporative Coolers and Accessories

## Blower Fans



**300 CFM Blower Fan**  
SKU 1392323  
MSC20300-A **119<sup>99</sup>**

- 120 Volts, 60 Hz
- For Indoor or Outdoor Use
- 3-Speed Switch (High, Medium, Low)
- 4-Position Adjustment Feet
- 8.5 Ft. Cord Length



**Heater Attachment for 300 CFM Blower**  
SKU OUTSIDE BUY/EPO  
MSC20300-HTR **69<sup>99</sup>**

- Converts Your 300 CFM Portable Blower into a Heater for Your Garage or Work Space
- 1320 Watts, 5000 BTU
- Fits Many Popular Brands (300 CFM Only. Not for 1,200 CFM Fans.)



For Outside Buy/EPO, Call 901-300-4878

Prices subject to change without notice. Prices do not include applicable taxes, vehicles, tires, rims, installation or optional equipment as shown. Please do not return purchases to the store. For information regarding warranty, repair, or any questions or concerns, call 901-300-4878.

AZG0225

# HEATING & COOLING

## Industrial Fans



**More Air, Less Noise Means Improved Comfort and Productivity**

- Output: 43,000 CFM
- 43.4 DB
- 110V

**AirMobile 59" Fan**  
SKU OUTSIDE BUY/EPO  
AMS81011300

**3,459<sup>99</sup>**

- Industrial Grade Casters



**AirFocus 59" Variable Speed Fan**  
SKU OUTSIDE BUY/EPO  
AMS81011304

**2,989<sup>99</sup>**

- Wall or Ceiling Mount

**AirFocus 59" Single Speed Fan**  
SKU OUTSIDE BUY/EPO  
AMS81011308

**2,549<sup>99</sup>**

- Wall or Ceiling Mount



**ECO Fan 8' Kit**

SKU OUTSIDE BUY/EPO  
HNT81011522-1P

**5,599<sup>99</sup>**

- Powerful and Economical
- Direct-Drive Motor
- Whisper-Quiet Air Circulation

ECO Fans Available in  
Diameters: 8' to 24'



**Titan Fan 14' Kit**

SKU OUTSIDE BUY/EPO  
HNT81011517-1P

**7,349<sup>99</sup>**

- Highest Performance and Versatility
- Direct-Drive Motor
- Whisper-Quiet Air Circulation

Titan Fans Available in  
Diameters: 14' to 24'

**Hunter Fan Kits Include: Down Rod, HMI Controller and VFD Control Panel**

To Confirm Price, Availability and Ordering Instructions on Outside Buy/EPO, Call 901-300-4878

## Exhaust Hoses

### Flarelock Hoses

- Made Exclusively for Cars and Small Trucks
- End is Flared to Permit Connection of 2 or More Links at a Time



**2.5" x 11'**  
SKU 977557  
ACSFLT250

**119<sup>99</sup>**

**3" x 11'**  
SKU 977559  
ACSFLT300

**149<sup>99</sup>**

**3.5" x 11'**  
SKU 977589  
ACSFLT350

**209<sup>99</sup>**

**4" x 11'**  
SKU 977590  
ACSFLT400

**229<sup>99</sup>**

### 3" Y-Assembly Kit with F300 Adapter

SKU OUTSIDE BUY/EPO  
ACSYA300

**249<sup>99</sup>**



### Door Port Adapters

#### For 2.5" Hose (Rubber)

SKU 977551  
ACSDF25

**49<sup>99</sup>**

- Rubber Garage Door Port Adapter
- Designed for 2-1/2" ID



#### For 3" Hose (Aluminum)

SKU 977552  
ACSADF30

**49<sup>99</sup>**

- Aluminum Port Allows Hose to Be Vented Through the Door



#### For 4" Hose (Aluminum)

SKU 977554  
ACSADF40

**74<sup>99</sup>**

- Use on 1" Thick Doors



### 2.5" Service Station Kit

SKU 977547  
ACSDSS25

**259<sup>99</sup>**

- 2 Each - 4' x 2-1/2" Hoses
- 1 Each - 6' x 2-1/2" Hose
- 1 Each - 2-1/2" Rubber "Y" Connector
- 2 Each - Straight Tailpipe Adapter, Hook and Chain
- 1 Each - Splice Connector



### 3" Service Station Kit

SKU 977548  
ACSDSS30

**264<sup>99</sup>**

- 2 Each - 4' x 3" Hoses
- 1 Each - 6' x 3" Hose
- 1 Each - 3" Rubber "Y" Connector
- 2 Each - Straight Tailpipe Adapter, Hook and Chain
- 1 Each - Splice Connector



### Bell Hose Adapters

- Designed for Easy Adapting to All Sorts of Tailpipes
- Connects with Ball and Snap

#### 2.5" Adapter

SKU 977544  
ACSRA250

**54<sup>99</sup>**

#### 3" Adapter

SKU 977545  
ACSRA300

**54<sup>99</sup>**



# HEATING & COOLING

TO ORDER, contact your Commercial Sales Manager or go to [AutoZonePro.com](http://AutoZonePro.com)

HEATING & COOLING

## Shop Heaters



On-board air compressor



Burn No.2 to 90W and synthetics



Small footprint

**Stop paying to have your waste oil hauled off!**  
Save and burn it for FREE heat this winter.



### 75H Waste Oil Furnace with Built-In 10 Gal. Tank

FURNACE	BTUs	HEATS UP TO	PART NO.	PRICE
EL-75	75,000	1,750 Sq. Ft.	ENL11075104	<b>3,999.99</b>

### Waste Oil Heater Complete Systems\*

FURNACE	BTUs	HEATS UP TO	PART NO.	PRICE	Reg. Price	Savings
EL-140	140,000	3,500 Sq. Ft.	ENL01140103	<b>11,399.99</b>	12,049.99	<b>\$650</b>
EL-200	200,000	5,000 Sq. Ft.	ENL01200104	<b>12,649.99</b>	13,349.99	<b>\$700</b>
EL-350	350,000	8,500 Sq. Ft.	ENL01350104	<b>14,399.99</b>	16,049.99	<b>\$1,650</b>

\* Complete systems include waste oil furnace and 250 gallon tank, swing-away burner with built-in air compressor, low-fuel cutoff, draft gauge, drain valve and Class A flue kit. Not for sale in CA

To Confirm Price, Availability and Ordering Instructions on Outside Buy/EPO, Call 901-300-4878



## Lanair

# EXTREME PERFORMANCE BURNER

**FREE Strainer Pan & Tank Gauge Included!**

	Heater Package*	BTUs	Heats up to	Part Number	Price
<i>Thru-roof chimney</i>	XT1503	150,000	3,500 sq. ft.	LANXT150C	<b>10,249.99</b>
	XT2003	200,000	5,000 sq. ft.	LANXT200C	<b>10,599.99</b>
	XT2503	250,000	8,500 sq. ft.	LANXT250C	<b>13,549.99</b>
	XT3003	300,000	10,00 sq. ft.	LANXT300C	<b>14,299.99</b>

\* Packages Include 215 Gallon Tank and 6" Chimney Kit.

For Outside Buy/EPO, Call 901-300-4878

Not For Sale in CA



NEW XT SERIES

## Sunfire

### Portable Radiant Heaters

- Quiet, Clean, Odorless
- Safe for Indoor Commercial Use

**NO SMELL NO FUMES**

#### 80,000 BTU

SKU **OUTSIDE BUY/EPO**  
SFRSF80

**1,799<sup>99</sup>**

- Heats up to 1,900 Sq. Ft
- Diesel or Kerosene
- 6 Gallon Tank

#### 120,000 BTU

SKU **OUTSIDE BUY/EPO**  
SFRSF120

**2,499<sup>99</sup>**

- Heats up to 2,800 Sq. Ft
- Diesel or Kerosene
- 14 Gallon Tank

#### 150,000 BTU

SKU **OUTSIDE BUY/EPO**  
SFRSF150

**3,199<sup>99</sup>**

- Heats up to 3,500 Sq. Ft
- Diesel
- 19 Gallon Tank



SFRSF150

## Exhaust Extraction



### Portable Exhaust Extraction System

SKU **OUTSIDE BUY/EPO**  
DOWEV5100 **1,449<sup>99</sup>**

- Works with Standard 3" Exhaust Hoses and "Y" Hose Adapters
- Captures Fumes and Discharges Them Safely Up to 30' Away
- Mobile Base Makes it Easy to Position and Move Around the Shop
- Uses Standard 110V Current
- Not for Use on Diesel
- Optional "Y" Hose Adapter Available for Dual-Exhaust Vehicles

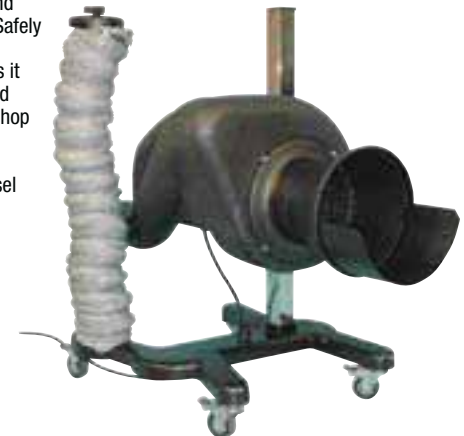

To Confirm Price, Availability and Ordering Instructions on Outside Buy/EPO, Call 901-300-4878

Prices subject to change without notice. Prices do not include applicable taxes, vehicles, tires, rims, installation or optional equipment as shown. Please do not return purchases to the store. For information regarding warranty, repair, or any questions or concerns, call 901-300-4878.

AZG0225

# AIR CONDITIONING

FOR MORE DETAILS ON RECOVERY MACHINES GO TO AZTOOL1.COM

## Recovery Machines

### ARCTIC COMMANDER 2.0

Dust Cover  
Included  
with All  
Machines



Warranty: 1 Year  
Parts and Labor

 <b>Mastercool</b> "World Class Quality"	Semi-Automatic R134a Recovery Machine SKU 1368632 MSC1100	Automatic R134a Recovery Machine SKU 1368636 MSC2100	Automatic R134a Hybrid Recovery Machine SKU 1368634 MSC3100	Automatic R1234yf Hybrid Recovery Machine SKU 1368616 MSC4100
Wi-Fi Capability	✓	✓	✓	✓
Refrigerant Database	Optional	✓	✓	✓
Built-In Tank Heater	✓	✓	✓	✓
Vacuum Pump	3 CFM	6 CFM	6 CFM	6 CFM
Dust Cover	✓	✓	✓	✓
Hose Flushing			✓	✓
Built-In Refrigerant Identifier				✓
Automatic Oil Injection		✓		
E-Printing Capability	Optional	Optional	✓	✓
<b>Price</b>	<b>3,799<sup>99</sup></b>	<b>4,749<sup>99</sup></b>	<b>5,049<sup>99</sup></b>	<b>6,549<sup>99</sup></b>

### ArcticPRO®



Warranty:  
2 Years Parts and 1 Year Labor

	Refrigerant 134a			Refrigerant 1234yf	
<b>MAHLE</b>	ACX-2150 R134a Recovery Machine SKU 213170 MSSACX2150	ACX-2180 R134a Recovery Machine SKU 213168 MSSACX2180	ACX-2180H R134a Hybrid Recovery Machine SKU 213203 MSSACX2180H	ACX-2250 R1234yf Recovery Machine SKU 213151 MSSACX2250	ACX-2280 R1234yf Recovery Machine SKU 1187032 MSSACX2280
Automatic Oil Drain	✓	✓	✓	✓	✓
Automatic Air Purge	✓	✓	✓	✓	✓
Included Database	Optional	✓	✓	Optional	✓
Automatic Oil and Dye Injection	✓	✓			
Includes Refrigerant Identifier				✓**	✓*
Phone Application	Optional	✓	✓	Optional	✓
<b>Price</b>	<b>4,399<sup>99</sup></b>	<b>5,099<sup>99</sup></b>	<b>5,099<sup>99</sup></b>	<b>6,349<sup>99</sup></b>	<b>7,249<sup>99</sup></b>

On-Board Integrated Thermal Printer (Optional) \*Integrated \*\*Non-Integrated

### MSX



Warranty:  
2 Years Parts and Labor

<b>cps</b>	R134a SKU 1407803 CPSMSX134	R1234yf SKU 1407806 CPSMSX1234	R134a/R1234yf SKU 1407510 CPSMSX3030	Heavy Duty R134a SKU 1407805 CPSMXHD
Fully Automatic	✓	✓	✓	✓
Onboard Oil Injection	✓			
High Capacity Oil-less Compressor	✓	✓	✓	✓
Vehicle Database Included	✓	✓	✓	✓
10 Ft. Service Hoses	✓	✓	✓	18' Hose
Includes 2 Tanks and 2 Sets of Hoses			✓	
Wi-Fi and Bluetooth Enabled	✓	✓	✓	✓
Touch Screen	7" Hi-Res	7" Hi-Res	7" Hi-Res	7" Hi-Res
Includes Refrigerant Identifier		✓	✓	
Converts Between R134a and R1234yf in 10 Min.			✓	
<b>Price</b>	<b>5,149<sup>99</sup></b>	<b>6,699<sup>99</sup></b>	<b>8,799<sup>99</sup></b>	<b>7,249<sup>99</sup></b>

# AIR CONDITIONING

TO ORDER, contact your Commercial Sales Manager or go to [AutoZonePro.com](http://AutoZonePro.com)

AIR CONDITIONING

## Recovery Machines

**KONFORT**



Warranty:  
2 Years Parts and Labor

TEXA	750R R134a Recovery Machine SKU 1282745 TEXZ11450	760 R1234yf Recovery Machine SKU 1282756 TEXA17910	780 Dual Gas Recovery Machine SKU 1282809 TEXA17810
Automatic Oil Drain	✓	✓	✓
Automatic Oil and Dye Injection	✓		
10 in. Multi-Touch Display		✓	✓
R134a Management	✓		✓
R1234yf Management		✓	✓
Vehicle Capacity Database	✓	✓	✓
Software Update Over Wi-Fi		✓	✓
Push-Pull Recovery	✓	✓	✓
Fully Automatic Operation	✓	✓	✓
<b>Price</b>	<b>5,399<sup>99</sup></b>	<b>8,749<sup>99</sup></b>	<b>10,549<sup>99</sup></b>

**ECOTECHNICS**



Training Videos



Warranty:  
1 Year Parts and Labor

Description	Hybrid Ready R134a SKU 1339733 HOFEEAC820B	Hybrid Ready R1234yf SKU 1335790 HOFEEAC830B	Eco Dual Gas A/C Service Station SKU 1335792 HOFEEAC800
Refrigerant Type	R134a	HFO-1234yf	R134a + HFO1234yf
Refrigerant Tank	30 Lb.	30 Lb.	30 Lb. + 30 Lb.
Command Valves	Automatic	Automatic	Automatic
Display	5" Touch	5" Touch	7" Touch
Database	✓	✓	✓
Printer	✓	✓	✓
Status Light	✓	✓	✓
Hybrid Function	✓	✓	✓
<b>Price</b>	<b>4,799<sup>99</sup></b>	<b>6,399<sup>99</sup></b>	<b>10,499<sup>99</sup></b>

**ROBINAIR**



Warranty:  
1 Year Parts and Labor

Description	AC1234-4 Premier R1234yf SKU 1212384 ROBAC1234-4	AC1234-9 Connected R1234yf ACS SKU 1212383 ROBAC1234-9	34288NI Economy R134a SKU 221185 ROB34288NI	34788NI-H Premier R134a Refrigerant for Hybrid and Non-Hybrid Vehicles SKU 751572 ROB34788NI-H	34788NI Premier R134a Refrigerant SKU 751569 ROB34788NI	34998 Connected R134a ACS SKU 1212385 ROB34998
Operation	Automatic	Automatic	Semi-Automatic	<ul style="list-style-type: none"> <li>Automatic</li> <li>Hybrid Vehicle Applications</li> </ul>	<ul style="list-style-type: none"> <li>Automatic</li> <li>Auto Oil Injection</li> </ul>	<ul style="list-style-type: none"> <li>Automatic</li> <li>Auto Oil Injection</li> </ul>
Display	4.3" LCD Display	10" Hi-Res Touch Screen	4.3" Full Color Display	4.3" Full Color Display	4.3" Full Color Display	10" Hi-Res Touch Screen
Printer	ROB30038 (optional)	Wireless Printing	ROB30038 (optional)	ROB30038 (optional)	ROB30038 (optional)	Wireless Printing
Bluetooth and Wi-Fi		✓				✓
<b>Price</b>	<b>6,595<sup>99</sup></b>	<b>7,499<sup>99</sup></b>	<b>4,149<sup>99</sup></b>	<b>4,999<sup>99</sup></b>	<b>4,999<sup>99</sup></b>	<b>5,999<sup>99</sup></b>

Prices subject to change without notice. Prices do not include applicable taxes, vehicles, tires, rims, installation or optional equipment as shown. Please do not return purchases to the store. For information regarding warranty, repair, or any questions or concerns, call 901-300-4878.

AZG0225

# AIR CONDITIONING

## A/C VACUUM PUMP KITS - BETTER VALUE FOR YOUR MONEY

### A/C Service Set with Air Vacuum Pump - R134a

SKU 850564  
68991

- Includes: Air Vacuum Pump with 1/2" ACME R134a and R12 Connectors, Brass Manifold Gauge Set with 60" Hoses and Snap Style Couplers, Brass Can Tap Valve, Large Diameter Dual Scale Thermometer



**99<sup>99</sup>**

REG. \$138.96

**SAVE OVER \$38**

When You Buy the Kit

### Starter A/C Vacuum Pump Kit - R134a

SKU 1400034  
68950

- Includes: 1.8 CFM, 100 Micron Single Stage Vacuum, Professional Quality Extruded Aluminum Manifold with 72" Hoses, High Quality Manual Couplers and R134a Can Tap



**199<sup>99</sup>**

REG. \$241.97

**SAVE OVER \$41**

When You Buy the Kit

### R134a and R1234yf Spark-Free A/C Vacuum Pump Kit

**OEM TOOLS**

SKU 1400036  
68951

- Includes: 6 CFM, 75 Micron, Spark-Free Single Stage Vacuum for Use with R134a or R1234yf, Extruded Aluminum Manifold Gauges, 72" Hoses with High Quality Manual Couplers, R1234yf Conversion Couplers That Convert R134a Manifold and Hoses to R1234yf, 1/2" ACME Right Hand to 1/2" ACME Left Hand Tank Adapter, 1/4" SAE x 1/2" ACME Hose to Vacuum Pump Adapter and R134a and R1234yf Can Tap

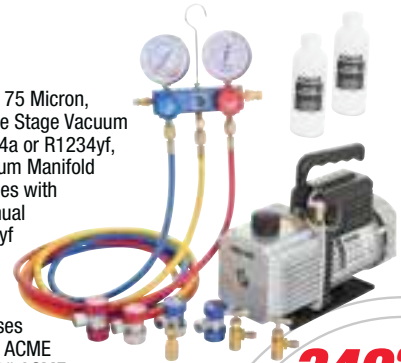

**349<sup>99</sup>**

REG. \$404.98

**SAVE OVER \$54**

When You Buy the Kit

### Recovery Machine Filters/Maintenance Kits

**ROBINAIR.**

**cps**

**Mastercool**  
"World Class Quality"

**MAHLE**

**ECOTECHNICS**

SKU	Part Number	Brand	Fits	Price
522875	ROB34430	Robinair	17700A, 34450, 34700, 34134Z	<b>133.99</b>
414883	ROB34724	Robinair	34288, 34788, 34788NI, 34788NI-H, 34988, 347002, 341342	<b>89.99</b>
752703	ROB13172	Robinair	Maintenance Kit for Models Using 34724 Filter - Includes Oil	<b>159.99</b>
186483	CPSARXF5	CPS	FX and AR Series CPS Equipment	<b>89.99</b>
1149172	CPSFX3030X1	CPS	Includes FX Series Filter, Vacuum Pump Oil and Coupler O-Rings for FX134A	<b>139.99</b>
389222	MSC69788FLTPK	Mastercool	69788, 69789 and 69789-H	<b>209.99</b>
199681	MSCCOM1FLTRPK	Mastercool	Commander 4000 and 4000x	<b>159.99</b>
199675	MSCCOM2FLTRPK	Mastercool	Commander 1000, 2000 and 3000	<b>199.99</b>
1149182	MSS3608325400	Mahle	ACX2180, ACX2180H and ACX2280	<b>119.99</b>
207349	MSS268077600	Mahle	ACX1120H, ACX1150, ACX1150H and ACX2120H	<b>119.99</b>
207508	MSS3608273900	Mahle	ACX1280, ACX2150 and ACX2250	<b>114.99</b>
818739	RTI3608213300	Mahle	RHS980 and ACX1180	<b>119.99</b>
1406968	HOFEEAC33023B	EcoTechnics	HOFEEAC800, HOFEEAC810, HOFEEAC820B, HOFEEAC830B	<b>99.99</b>

### Portable Recovery Systems

#### R-134 Twin Turbo Complete Recovery Machine

SKU OUTSIDE BUY/EPO  
MSC69360

**1,949<sup>99</sup>**

- Largest Volume Recovery Rate on the Market
- For Use with All Refrigerants Including R410A
- Injection Molded High Density Polyethylene Case for Maximum Durability
- Safety High Pressure Switch
- Revolutionary Double Piston Oil-Less Compressor



#### R1234yf Twin Turbo Complete Recovery Machine

SKU OUTSIDE BUY/EPO  
MSC69360-YF

**1,849<sup>99</sup>**

- Revolutionary Double Piston Oil-Less Compressor
- Largest Volume Recovery Rate on the Market
- Includes: 30 Lb. DOT Tank, Sight Glass, R1234yf Low Side Coupler, Oil Drain Bottle and R1234yf Blue and Yellow Hoses



#### R134a/R1234yf Complete A/C Recovery Set

**Mastercool**  
"World Class Quality"

SKU OUTSIDE BUY/EPO  
MSC69372

**1,999<sup>99</sup>**

- Built with the Safest Spark-Free Components
- Includes All Hoses and Couplers Needed to Recover, Cleanse and Remove the Oil from R134a and R1234yf Automotive A/C Systems
- 30 Lb. DOT Tank for R134a and 30 Lb. DOT Tank for R1234yf Refrigerants Included with Each Unit (Refrigerant Sold Separately)
- 115V/60 Hz
- 1/2 HP Oil-Less Compressor
- Compatible Refrigerants: All CFCs, HCFCs and HFCs



To Confirm Price, Availability and Ordering Instructions on Outside Buy/EPO, Call 901-300-4878

Prices subject to change without notice. Prices do not include applicable taxes, vehicles, tires, rims, installation or optional equipment as shown. Please do not return purchases to the store. For information regarding warranty, repair, or any questions or concerns, call 901-300-4878.



## Vacuum Pumps

### 1.8 CFM Single Stage Vacuum Pump

SKU 466312 **129<sup>99</sup>**  
24500

- Motor: 1/4 HP, 110V
- Ultimate Vacuum Rating: 100 Microns
- Inlet Ports: 1/2" ACME - 1/4" Flare
- Oil Capacity: 6.7 Oz. (200 mL), Included
- Internal High Volume Cooling Fan for Extended Use



**OEM TOOLS**



### 4 CFM Single Stage Vacuum Pump

SKU 466305 **139<sup>99</sup>**  
24501

- Motor: 1/3 HP, 110V
- 75 Microns
- Inlet Ports: 1/2" ACME 1/4" Flare
- Oil Capacity: 11 Oz. (330 mL), Included
- Internal High Volume Cooling Fan for Extended Use



**OEM TOOLS**



### 6 CFM Single Stage Vacuum Pump

SKU 466306 **164<sup>99</sup>**  
24502

- Motor: 1/2 HP, 110V
- 75 Microns
- Inlet Ports: 1/2" ACME - 1/4" Flare
- Oil Capacity: 11 Oz. (330 mL), Included
- Internal High Volume Cooling Fan for Extended Use



**OEM TOOLS**



### 6 CFM Spark-Free Vacuum Pump

SKU 213133 **259<sup>99</sup>**  
24642

- Motor: Spark-Free 1/2 HP, 110V
- Ultimate Vacuum Rating: 75 Microns
- 3 Inlet Ports: 1/4" Flare, 1/2" ACME and 1/2" ACME LH
- Oil Capacity: 330 mL, Included
- Internal High Volume Cooling Fan for Extended Use
- Can Be Used with R1234yf Refrigerant



**OEM TOOLS**



### Black Series 1.8 CFM Single Stage Vacuum Pump

SKU 1414397 **169<sup>99</sup>**  
MSC90059-BL

- 80 Microns
- 1/4 HP
- 110/120 V, 60 Hz
- T-Fitting 1/4" FL-M x 1/2 ACME-M



**Mastercool**  
"World Class Quality"

### 1.8 CFM Deep Vacuum Pump

SKU 1330695 **179<sup>99</sup>**  
MSC290059RCL

- 1.8 CFM Deep Vacuum Pump
- 1/4" and 1/2" Fittings
- For Use with Multiple Refrigerants



**Mastercool**  
"World Class Quality"

### 3 CFM Single Stage Vacuum Pump

SKU 1392324 **199<sup>99</sup>**  
MSC290062

- Large Fan Keeps Vacuum Pump Cooler and Extends Life
- 1/4" SAE and 1/2" ACME Port Access
- 110-120V, 60 Hz Voltage



**Mastercool**  
"World Class Quality"

### 6 CFM 2 Stage Vacuum Pump

SKU OUTSIDE BUY/EPO **399<sup>99</sup>**  
MSC900662V-BL

- 15 Microns
- 1/2 HP
- 110/220 V, 50/60 Hz
- Includes: 3 Inlet Ports: 1/4", 3/8" SAE and 1/2" ACME



**Mastercool**  
"World Class Quality"

For Outside Buy/EPO,  
Call 901-300-4878

### Spark-Free 6 CFM Vacuum Pump (Single Stage)

SKU 1400035 **354<sup>99</sup>**  
MSC90066BLSF

- 80 Microns
- 1/3 HP
- 110/120V, 60HZ
- T-Fitting 1/4" FL-M x 1/2 ACME-M



**Mastercool**  
"World Class Quality"

### Air-Operated Vacuum Pump

SKU 544730 **39<sup>99</sup>**  
24533

- Includes: 1/2" ACME (R134a) and R12 Connectors
- Air Pressure Range: 75 to 180 psi
- Air Consumption: 4.2 CFM @ 90 psi
- Vacuum Capacity: 28.3" of Mercury @ 90 psi



**OEM TOOLS**

### Vacuum Pump Oil (8 Oz.)

SKU 363429 **10<sup>00</sup>**  
24399

- Increases Life Span of the Pump
- Performance of Your Pump Depends on Regular Service and the Quality and Purity of the Vacuum Pump Oil That You Use
- Compatible for Use in Pumps Made by Most Manufacturers



**OEM TOOLS**

### Premium Vacuum Pump Oil 1 Quart Bottle

SKU 517580 **19<sup>99</sup>**  
CPSVPOQ12

- Compatible with Most Pumps
- Increases Life Span of the Pump
- Performance of Your Pump Depends on Regular Service and the Quality and Purity of the Vacuum Pump Oil That You Use



**CPS**

**STORE STOCKED**

# AIR CONDITIONING

## Manifold Gauges

### R1234yf Manifold Gauge and Hose Set

SKU 752518 **149<sup>99</sup>**  
24559

- 3" Easy-to-Read Gauges with Temperature Chart
- 72" Hoses
- High Quality 6-Ball Manual Couplers

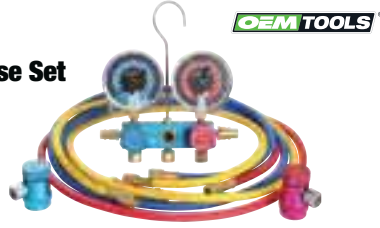

### Dual Aluminum R134a/R1234yf Gauge Set

SKU 1335797 **144<sup>99</sup>**  
25130

- Includes: 72" Hoses, Manual Couplers and Can Tap Valves with 1/2" ACME Fittings for Use with Both R134a and R1234yf Refrigerants

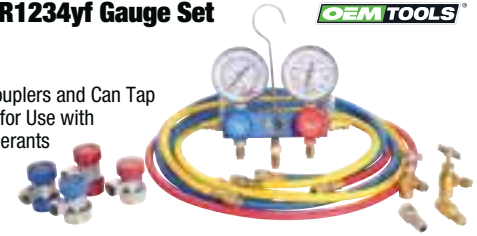

### R134a Brass Manifold Gauge Set

SKU 752520 **74<sup>99</sup>**  
24563

- High Quality Brass Body with Sight Glass
- Large 2-1/2" Gauges are Easy to Calibrate and Have a High Impact Lexan Lens
- 60" Hoses (3,000 psi Working Pressure)
- Snap Style Quick Couplers

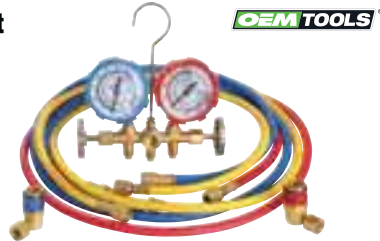

### R134a A/C Manifold Gauge and Hose Set

SKU 466319 **99<sup>99</sup>**  
24527

- Easy-to-Read 2-3/4" Spring Dampened Gauges to Reduce Flutter
- Extruded Aluminum Manifold
- 72" Hoses with Manual Couplers



### Deluxe R134a Gauge Set

SKU 1282751 **119<sup>99</sup>**  
MSC289772CL

- Solid Block Extruded Aluminum Manifold
- 72" Long Hoses with Manual Couplers
- Gauge Guards for Protection

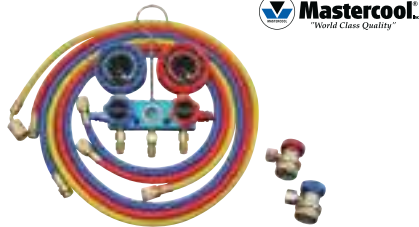

### Dual R134a, R-12 Manifold Gauge Set

SKU 1335804 **139<sup>99</sup>**  
MSC293996PBCL

- Solid Block Extruded Aluminum Manifold
- 96" Long Hoses with Manual Couplers
- Gauge Guards for Protection
- Silicone Dampened Calibratable Gauges
- Extra Long Hose for Access to Heavy Duty Buses, Fleet and Refrigerated Trucks Systems



### R134a Aluminum Manifold Kit with Dye Injector

SKU 290023 **154<sup>99</sup>**  
MSC89660UV

- Includes: R134a Aluminum Manifold, 60" Hoses, Standard Couplers and 10 Application Mini Dye Injector



### Dual R134a/R1234yf Brass Gauge Set

SKU 1142631 **164<sup>99</sup>**  
MSC66661AYF

- 2-1/2" Silicone Dampened, Recalibrateable Gauges
- Extra Access Port for Vacuum Line
- R1234yf High and Low Side Quick Couplers R134a High and Low Side Economy Couplers 1/2" ACME-M x 1/2" ACME-F LH Thread Adapter (2) 12 mm-M x 14 mm-F R1234yf Adapters Set of 3 - R134a Standard Hoses



### R1234yf Aluminum Manifold Gauge Set

SKU 505065 **249<sup>99</sup>**  
MSC83272

- Ideal for Shops That Want to Wait to Invest in New AC Service Stations Adapted for R1234yf
- Contains Manifold, 3 Service Hoses, 2 Service Couplers LT/HT



### Dual Aluminum R134a/R1234yf Gauge Set

SKU 1086254 **289<sup>99</sup>**  
MSC89661AYF

- Professional Extruded Aluminum Block
- 2-1/2" Silicone Dampened, Re-Calibrateable Gauges
- Free-Floating Piston Type Valves Reduce O-Ring Wear
- R1234yf High and Low Side Couplers with Extended Disconnect Protection Sleeve
- Standard Hoses, R134a Manual Couplers, R1234yf Couplers, 1/2" ACME-M x 1/2" ACME-F LH Thread Adapter, (2) 12 mm-M x 14 mm-F R1234yf Adapters



## Can Taps

### R1234yf Self-Sealing Can Tap

SKU 213178 **11<sup>99</sup>**  
24553

### R134a Can Tap Valve

SKU 466315 **11<sup>99</sup>**  
24524



### 4-Way Side Can Tap

SKU 1103203 **34<sup>99</sup>**  
FJC6842

- For Use with R-12, R134a or R1234yf Refrigerant Cans and Oil Change Cans
- Fits Cans with 2-7/8", 2-1/2" and 2" Diameter
- Includes: 1/2" ACME LH, 1/2" ACME and 1/4" Flare Male Fitting with Check Valve



### Refrigerant and Oil Charge Side Can Tap

SKU 466313 **15<sup>99</sup>**  
24523

- Fits 1 Lb. Cans of R134a, R12 and 2" Oil Charge Cans
- Plier Type Grip with Positive Lock
- Includes: 1/2" ACME Male and 1/4" FL Male Ports with Safety Valve



### 3-In-1 Side Mount Can Tap Valve

SKU 290033 **19<sup>99</sup>**  
MSC85530

- Unique Design will Work on All R134a (2-7/8"), R12 (2-1/2") and Oil Charge (2") Cans
- Outlet Port Offers a 1/2" ACME and 1/2" FL Fitting with an Internal Check Valve to Prevent System Backflow



Prices subject to change without notice. Prices do not include applicable taxes, vehicles, tires, rims, installation or optional equipment as shown. Please do not return purchases to the store. For information regarding warranty, repair, or any questions or concerns, call 901-300-4878.

## Electronic Leak Detection

### A/C Refrigerant Leak Detector

SKU 466307 **79<sup>99</sup>**  
24510

#### Detects All Types of Halogenated Refrigerants

- Sensitive to 0.1 Oz. per Year Single Color LED Display with 7 Level Leak Alarm
- Flexible Stainless Steel Probe to Reach Almost Any Space
- Includes Spare Sensor Tip
- Works with 1234yf



OEM TOOLS®  
World Class Quality

### Black Series Infrared Refrigerant Leak Detector

SKU OUTSIDE BUY/EPO **499<sup>99</sup>**  
MSC55600-A

- Easily Select Sensitivity Levels with a Maximum Sensitivity Up to 0.14 Oz./Yr.
- TFT Screen Provides Clear and Easy Readings That Show Leakage, Sensitivity, Battery Level and Sensor Fault Indicators
- Designed to Meet EN14624, SAE1627, SAE2791 and SAE2913 Standards

For Outside Buy/EPO, Call 901-300-4878



Mastercool®  
World Class Quality

### Raptor Refrigerant Leak Detector

SKU 916550 **239<sup>99</sup>**  
MSC56100

- Features 3 Sensitivity Levels and 5 Detection Levels
- Detects Leaks as Small as 1/10 Oz. per Year
- Detects All Refrigerants (CFC, HCFC, HFC)
- Flexible 16" Probe for Hard-to-Reach Areas
- Works with 1234yf



Mastercool®  
World Class Quality

### Inspector 2-in-1 Electronic/UV Leak Detector

SKU 916553 **289<sup>99</sup>**  
MSC56200

- Pinpoint Leaks as Small as 1/10 Oz. (3 gr) Per Year
- Built-In Ultra-Bright UV Light at End of Probe – Allowing Easy Access into Tight Areas
- Works with 1234yf



Mastercool®  
World Class Quality

## Manifold Gauge Repair

### Replacement Gauge High Side for A/C Manifold

SKU 481705 **19<sup>99</sup>**  
24530

- Replacement High Side Gauge Fits OEMTOOLS® and Other Brands of A/C Manifolds Used to Service A/C Systems on Cars
- 1/8" NPTF Male Threads
- Reads 0 to 500 psi



### Replacement Gauge Low Side for A/C Manifold

SKU 481709 **19<sup>99</sup>**  
24531

- Reads 0 to 120 psi and 0 to 30" Hg

Mastercool®  
World Class Quality

### R134a/R12 Charging Hose Repair Kit

SKU 295557 **39<sup>99</sup>**  
MSC91334-A

- 50 Piece Assortment of Replacement Gaskets, O-Rings, Depressors for Charging Hoses and Adapters



### A/C Manifold Upgrade Kit

SKU 1043688 **68903**

- Includes: 3-in-1 Side Mount Can Tap Valve, R134a Manual Coupler Set, 1234yf Self Sealing Can Tap, 1/2" ACME Hose Set 72", R134a to HFO-1234YF Conversion Coupler Set



OEM TOOLS®

**129<sup>99</sup>**

REG. \$152.95

SAVE OVER **\$22**

When You Buy the Kit

### R1234yf Manifold/Hose Adapter Assortment

SKU 1142732 **19<sup>99</sup>**  
25091

- 6 Common Adapters to Fit Manifolds, Hoses, Couplers and Vacuum Pumps
- Includes: 1/2" LH ACME Female x 1/4" Male Flare, 1/2" ACME Male x M12 x 1.5 Male, 1/2" ACME Female x M12 x 1.5 Female, 1/4" Male Flare x M12 x 1.5 Male, 1/2" LH ACME Female x M14 QDK, 1/2" LH ACME Male x 1/4" Female Flare
- Includes Organizer Case with I.D. Labels



OEM TOOLS®

### 72 Pc. Valve and Gasket Set

SKU OUTSIDE BUY/EPO **14<sup>99</sup>**  
25099

- Includes: 50 Common Gaskets for 134a Hoses and Manifold Sets, 10 Replacement Valves and 10 Replacement Valve Cores
- Includes: Valve Core Replacement and Installation Tool and Organizer Case



OEM TOOLS®

**NEW**

For Outside Buy/EPO, Call 901-300-4878

## Hoses

### R1234yf 72" Hose Set

SKU 1142322 **89<sup>99</sup>**  
MSC83372

- Working Pressure: 800 psi
- Burst Pressure: 4,000 psi
- For Use with R1234yf
- Meets J2888, EPA, SAE and UL Standards
- Includes: 1 ea. Blue/Red 72" 12 mm-M x 12 mm-M and Yellow 72" 12 mm Fitting x 1/2 x 16 ACME LH

### 96" R134a Red Hose

SKU 489152 **39<sup>99</sup>**  
MSC84963

- 1/2" ACME-F and 14 mm-M Auto A/C Fittings - 96"

### 96" R134a Blue Hose

SKU 489151 **39<sup>99</sup>**  
MSC84961

- 1/2" ACME-F and 14 mm-M Auto A/C Fittings - 96"

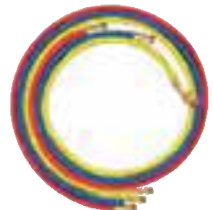

Mastercool®  
World Class Quality

### 96" 2 Pc. 1234yf Recovery Hose Set

SKU 85829 **29<sup>99</sup>**  
25010

- Includes 96" Set Blue/Red 12 mm-M x 12 mm-M
- Meets or Exceeds SAE J2888 Standards

### 72" R1234yf Hoses

SKU 85803 **34<sup>99</sup>**  
25009

- Includes: (2) 72" High/Low Charging Hoses with 12 mm Male Fittings and 72" Charging Hose with 12 mm and 1/2" x 16" Left Hand Acme Fitting
- Meets or Exceeds SAE J2888 Standards

### 72" R134a Hose Set

SKU 752516 **49<sup>99</sup>**  
24558

- 72" R134a 3 Hose
- Set Color Coded: Red, Yellow and Blue

### 72" 1/4" Hose Set

SKU 752515 **29<sup>99</sup>**  
24557

- 72", 1/4" SAE 3 Hose
- Color Coded: Red, Yellow and Blue



24558



24557

# AIR CONDITIONING

## A/C Couplers

### R134a Manual Coupler Set

SKU 362980 **24<sup>99</sup>**  
24396

- All Metal Construction for Extra Durability
- 6-Ball Coupler for Secure Grip
- Includes: Adapter for Use with R12 Hoses



### R134a High Side Manual Coupler

SKU 347267 **17<sup>99</sup>**  
24395

### R134a Low Side Manual Coupler

SKU 347266 **17<sup>99</sup>**  
24394

### Manual R134a Safety Lock Coupler



- Suitable for Use On All R134a Systems
- Safety Lock Ensures That Hose Remains Connected During Operation
- Meets All SAE, UL and EPA Requirements for Containment of Refrigerant

### High-Side, 1/4" FL-M x 16 mm

SKU 695636 **39<sup>99</sup>**  
MSC82834-SLE



### Low-Side, 3/8" FL-M x 13 mm

SKU 695637 **39<sup>99</sup>**  
MSC82934-SLE



### 1234yf Manual Coupler Set with 134a Hose Adapters and Acme Adapter

SKU OUTSIDE BUY/EPO **39<sup>99</sup>** **NEW**  
25093

- Couplers Have 12 mm F Threads to Connect to 1234yf Hose Connections
- Two 12 mm M to 14 mm F Brass Adapters Included for Use with 134a Hoses
- Includes: 1/2" M to 1/2" F Left Hand Acme Adapter



### R1234yf High-Side Coupler and Adapter Set

SKU OUTSIDE BUY/EPO **19<sup>99</sup>**  
25094

### R1234yf Low-Side Coupler and Adapter Set

SKU OUTSIDE BUY/EPO **19<sup>99</sup>**  
25095

For Outside Buy/EPO, Call 901-300-4878

### Conversion Coupler Set R134a to R1234yf

SKU 752527 **49<sup>99</sup>**  
24561

- 1234yf Manual Couplers with 14 mm Female Threads to Convert R134a Manifold and Hoses to R1234yf
- Includes: Tank Adapter, 1/2" ACME Right Hand to 1/2" ACME Left Hand Adapter



### R134a Refrigerant Tank Adapter

SKU 850565 **14<sup>99</sup>**  
24554

- Male Low-Side R134a to Female 1/2" ACME
- Attaches to Virgin Tank and Low-Side Service Coupler



### R1234yf Low Side Tank Adapter Assembly

SKU 1103204 **14<sup>99</sup>**  
25086

- Used to Fill Refrigerant from R1234yf Cylinders
- Attaches to Virgin Tank and Low Side Service Coupler
- This Fitting Does Not Have a Valve Core or Valve Core Depressor



### R1234yf Hose to Vacuum Pump Adapter Fitting 1/4" x 1/2"

SKU 600806 **12<sup>99</sup>**  
24509

- 1/4" SAE x 1/2" ACME Female LH Thread



## Valve Core Tools

### A/C Valve Core Tool

SKU 466314 **12<sup>99</sup>**  
24555

- Double Ended Valve Core Tool to Service Both Standard and Large Bore R134a and R12 Cores

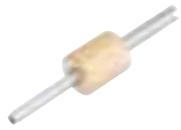

### No Gas Loss A/C Valve Core Remover/Installer

SKU 466321 **37<sup>99</sup>**  
24529

- Remove and Install Standard R134a Valve Cores without the Loss of Refrigerant
- Built-In Ball Valve Retains Charge and Allows Access to A/C System
- For 13 mm and 16 mm High and Low Service Ports
- Includes Blow Mold Case



### Universal Valve Core Remover/Installer for R1234yf

SKU 1043686 **134<sup>99</sup>**  
MSC58490-YF

- Attaches to R1234yf Service Ports to Quickly and Easily Remove and Replace Valve Cores without the Loss of Refrigerant
- Ball Valve Design with Stainless Steel Ball Provides Smooth Movement and Durability
- Kit Covers 17 mm and 14 mm High and Low Side Service Ports
- Includes: Valve Assembly, High Side 17 mm Connector, Low Side 14 mm Connector, Standard Valve Core Shaft, GM Large Bore Valve Core Shaft and Eaton R134a/R1234yf High Side Valve Core Shaft



### Universal Valve Core Remover/Installer for R134a/R12

SKU 1142576 **209<sup>99</sup>**  
MSC58490

- Kit Covers All R12 and R134a System Valve Cores for Standard, JRA, Eaton and GM Large Bore
- Includes: Valve Assembly, R134a High Side 16 mm Connector, R134a Low Side 13 mm Connector, 1/4" FL Swivel Connector, Adapter 1/4"-M x 3/16"-F High Side GM/Ford, Adapter 1/4"-M x 1/8"-F High Side Ford and Blow Mold Case



## A/C Service Tools

### A/C Condenser Fin Comb Straightener/Cleaner

SKU 466317 **9<sup>99</sup>**  
24526

- Clean and Straighten Condenser and Evaporator Coils
- Compact Design for Confined Spaces
- 6 Clearly Marked Combs: 8, 9, 10, 12, 14 and 15 Fins per Inch



### Valve Core Tool Set (2 Piece)

SKU 1209377 **12<sup>99</sup>**  
22589

- Designed for Removal and Installation of Schrader Style Valve Cores

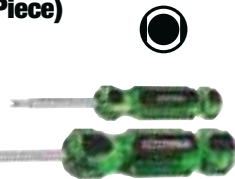

### A/C Clutch Holding Tool

SKU 1392339 **19<sup>99</sup>**  
26550

- Holds Compressor Clutch in Place When Removing the Holding Bolt
- Adjustable Pins to Fit Various Compressor Clutches
- Compatible with Domestic and Import Vehicles



### A/C Clutch Hub Puller and Installer

SKU 1103539 **79<sup>99</sup>**  
37150

- Features All the Tools Necessary to Remove and Install Pressed on A/C Clutch Hubs on Many Domestic and Import Vehicles
- Includes: Orifice Tube Extractor Tool Set

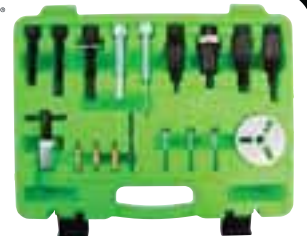

**BONUS VALUE: \$29.99**

### 26 Piece Master Orifice Tube Assortment

24564

With Purchase of: 37150

Offer Good While Supplies Last Through June 30, 2025



## SpotGun® Jr.

### SpotGun® Jr. Univ. Oil/UV Dye Kit for R134a/R1234yf - 1 Oz.

SKU 1368623 **199<sup>99</sup>**  
UVU390100

- Works with Both R134a and R1234yf Refrigerant Systems
- 4 Universal Oil Cartridges (1 Oz.)
- 2 ExtenDye™ Cartridges (1 Oz.)
- 2 LeakGuard™ OneShot Cartridges (1 Oz.)
- 2 Low-Side Service Adapter Hoses and R134a/R1234yf Couplers



### SpotGun® Jr. Univ. Oil/UV Dye Kit for R134a/R1234yf - 1 Oz. with UV Lite

SKU 1400039 **254<sup>99</sup>**  
UVU390200

- Works with Both R134a and R1234yf Refrigerant Systems
- Includes UV Phazer (AAA) UV Lite and UV Enhancing Glasses
- 4 Universal A/C Oil (1 Oz.)
- 2 ExtenDye™ Cartridges (1 Oz.)
- 2 LeakGuard™ OneShot Cartridges (1 Oz.)



### A/C ExtenDye™ Cartridge

- SAE J2297 Certified Super Concentrated UV Dye
- Works in R134a, R1234yf Systems and is Hybrid Safe
- Contains Friction Modifier to Increase Lubricity and Decrease Friction
- Contains Antioxidant to Prolong Oil Life
- Anti-Wear Additive for Better Wear Resistance
- Works with SpotGun® Jr. Injection System

### A/C ExtenDye™ Cartridge 1 Oz. (4 Pack)

SKU 1362004 **54<sup>99</sup>**  
UVU399020A



### A/C ExtenDye™ Cartridge .25 Oz. (6 Pack)

SKU OUTSIDE BUY/EPO **54<sup>99</sup>**  
UVU399006A



### Universal PAG 46 Oil for R134a 10z. Cartridge (12 Pack)

SKU 1407808 **84<sup>99</sup>**  
UVU399046

- OEM Approved
- Works with SpotGun® Jr. Injection System
- Formulated to Work with R1234yf, R134a and Hybrid Safe
- Sealed Cartridge Assures Clean Oil Delivered to Vehicle A/C System
- Injection System Measures the Correct Dosage

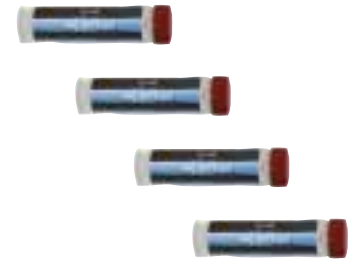

### Universal PAG 46 Oil R1234yf - 1 Oz. Cartridge (4 Pack)

SKU OUTSIDE BUY/EPO **49<sup>99</sup>**  
UVU399046YF

To Confirm Price, Availability and Ordering Instructions on Outside Buy/EPO, Call 901-300-4878

## SpotGun®

### SpotGun® Univ. Oil/Dye Kit for R134a/R1234yf - 8 Oz. without UV Lite

SKU OUTSIDE BUY/EPO **169<sup>99</sup>**  
UVU490100

- Works with Both R134a and R1234yf Refrigerant Systems
- 1 Universal Oil Cartridge (8 Oz.)
- 1 ExtenDye™ Cartridge (8 Oz.)
- Service Maintenance Stickers
- 2 Low-Side Service Adapter Hoses and R134a/R1234yf Couplers



### SpotGun® Univ. Oil/Dye Kit for R134a/R1234yf - 8 Oz. with UV Lite

SKU OUTSIDE BUY/EPO **224<sup>99</sup>**  
UVU490200

- Works with Both R134a and R1234yf Refrigerant Systems
- 1 Universal Oil Cartridge (8 Oz.)
- 1 ExtenDye™ Cartridge (8 Oz.)
- UV Phazer™ Black (AAA Batteries Included) UV Enhancing Glasses



### A/C ExtenDye™ Cartridge - 8 Oz.

SKU OUTSIDE BUY/EPO **69<sup>99</sup>**  
UVU499108A

- Works in R134a, R1234yf Systems and is Hybrid Safe
- Contains Friction Modifier
- Contains Antioxidant to Prolong Oil Life
- Fits Competitive Guns



## Mastercool

### Professional UV Leak Detection Kit with 12V/50W UV Light

SKU 290041 **99<sup>99</sup>**  
MSC53351

- 12 Volt/50 Watt UV Leak Detector
- 1 Oz. Coolant Dye, 1 Oz. Oil/ATF/Fuel Dye, Dye Remover
- Mini Dye Injector (10 Applications of Universal A/C Dye) Compatible with R134a and R12 Adapter
- UV Enhancing Safety Glasses
- 12 Service Labels



### Universal Concentrated Dye Cartridge 1 Oz. (5 Pack)

SKU 505040 **99<sup>99</sup>**  
MSC53810-5

- 5 Pack of Dye for 53585 Leak Detector Kit
- 10 Applications per Bottle



# AIR CONDITIONING

## Leak Detection Lights

### 13.4" Multi-Use Rechargeable Diagnostic Under-the-Hood Work Light

SKU 591153 24609 **79<sup>99</sup>**

- 5 Hr. Run Time on High



OEM TOOLS

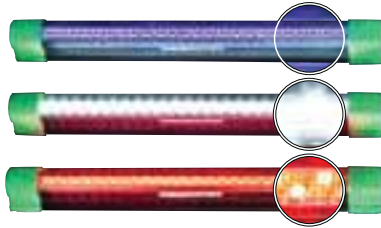

UV Leak Dye Detection Light

400 Lumens Super Bright Work Light

Yellow Smoke Detection Light

## Rechargeable UV Flashlight

SKU OUTSIDE BUY/EPO MSC53518UV **99<sup>99</sup>**

- High-Intensity LED Ensures Superior Illumination for Accurate Leak Detection
- 2W Lamp Power: Provides Powerful Performance In a Compact Design
- UV Intensity: 154–170 μW/cm<sup>2</sup>, Comparable to a 50-Watt UV Flashlight
- UV Wavelength: Operates At 390–400 Nm for Optimal Detection
- Rechargeable Battery: Delivers 3 to 5 Hours of Continuous Use
- Backup Power Option: Includes Holder and 3 AAA Batteries

For Outside Buy/EPO, Call 901-300-4878



Mastercool  
"World Class Quality"

## UV Phazer Professional 395nm Leak Detection Light

- Adjustable Zoom Lens Allows for Focusing Light Intensity In a Smaller/Larger Area for Precision Viewing
- Rechargeable Li-ion Battery

### Black

SKU 1405963 99<sup>99</sup>  
UVUEW40395

- High Output True UV LED Light
- Precise, True UV Wavelength and Bandwidth to Optimize the Fluorescence of UV Dyes
- Max. Run Time: 4 Hrs.



### NEO

SKU 1400042 139<sup>99</sup>  
UVUEW50395

- UV Dye Shines Brighter with the Phazer Neo Than Any Other UV Light
- Water Resistant
- Max. Run Time: 5 Hrs.



VIEW

## UV Leak Detection Light and Glasses

SKU 213144 19<sup>99</sup>  
24516

- Compact UV Leak Detection Pen Light
- Can Be Used with All Types of UV Leak Detection Dyes
- Yellow Lens Protective Glasses Enhance Visibility of Leaks



OEM TOOLS



2 AA

## Magnifying Glass with 5 LED and 1 UV Light

SKU 191688 14<sup>99</sup>  
25465

- Compact Magnifier with 5 LED Lights and a Super Bright UV Light
- UV Light Detects Dyes



OEM TOOLS

## Refillable Injectors

OEM TOOLS

### In-Line Dye and Oil Injector

SKU 466322 39<sup>99</sup>  
24532

- Add Up to 2 Oz. of Oil or Dye to a System Under Vacuum or While Adding Refrigerant
- 1/2" ACME Fittings to Fit Most R134a Systems
- Use with UVU499008A A/C ExtenDye™ Bottle (8 Oz.)



### R12 and R134a Hand Turn Dye Injector

SKU 466320 69<sup>99</sup>  
24528

- Injects Dye or Oil into R12 or R134a Systems
- Refillable, Capacity: 2 Oz.
- Includes: R134a Quick Coupler
- Use with UVU499008A A/C ExtenDye™ Bottle (8 Oz.)

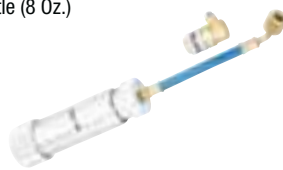

OEM TOOLS

## Pourable Dyes

VIEW

### A/C ExtenDye™ Bottle - 8 Oz.

SKU OUTSIDE BUY/EPO 54<sup>99</sup>  
UVU499008A

- SAE J2297 Certified Super Concentrated UV Dye
- Works in R134a, R1234yf Systems and is Hybrid Safe
- Contains Friction Modifier to Increase Lubricity and Decrease Friction
- Contains Antioxidant to Prolong Oil Life
- Anti-Wear Additive for Better Wear Resistance

For Outside Buy/EPO, Call 901-300-4878



### Multi-Purpose Dye

SKU 1392316 44<sup>99</sup>  
UVUB483206

- Pinpoint Leaks in Engine Oil, Transmission, Hydraulic, Power Steering, Gasoline and Diesel Fuel Systems



### R1234yf Hand Turn Oil and Dye Injector

SKU 213158 84<sup>99</sup>  
24517

- Easy to Operate Hand Turn Injection
- Durable Aluminum Construction with Laser Etched Filling Guide
- Includes R1234yf System Coupler
- 2 Oz. (60 mL) Capacity
- Use with UVU499008A A/C ExtenDye™ Bottle (8 Oz.)

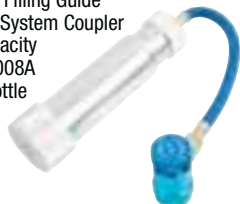

OEM TOOLS

### Refillable Universal Dye Injector for R1234yf

SKU 764999 149<sup>99</sup>  
MSC53123-YF

- Heavy Duty Aluminum Construction
- Injects Dye or Oil into R1234yf Systems
- Refillable, Any Dye or Oil Can Be Used
- Easy Twist Injection System
- Precise Injection Control



Mastercool  
"World Class Quality"

### PAG 100 Oil with A/C ExtenDye™ 8 Oz. Bottle (4 Pack)

SKU OUTSIDE BUY/EPO 79<sup>99</sup>  
UVU488100PBD4

- PAG 100 Oil
- Contains ExtenDye for Leak Detection
- A/C ExtenDye Includes Additive Package to Reduce Wear
- A/C ExtenDye Will Extend Component Life and Improve A/C Efficiency
- Formulated to Have the Correct Dye/Oil Performance

For Outside Buy/EPO, Call 901-300-4878



Prices subject to change without notice. Prices do not include applicable taxes, vehicles, tires, rims, installation or optional equipment as shown. Please do not return purchases to the store. For information regarding warranty, repair, or any questions or concerns, call 901-300-4878.

# AIR CONDITIONING

TO ORDER, contact your Commercial Sales Manager or go to [AutoZonePro.com](http://AutoZonePro.com)

AIR CONDITIONING

## Orifice Tube

OEM TOOLS

### 26 Piece Master Orifice Tube Assortment

SKU 851868  
24564 **29<sup>99</sup>**

- Covers Most Vehicles That Require Air Conditioning Orifice Tubes
- Includes: Chrysler (Orange, Purple T-Top), Ford (Black, Blue, Brown, Green, Red), GM (Black T-Top, White, Yellow), Jeep (Green - White) and Volvo (Yellow)



## A/C O-Ring Assortment

HARDWARE  
MACHINERY

### 270 Piece A/C O-Ring Kit

SKU 271196  
68141 **17<sup>99</sup>**

- Great O-Ring Set for Most Automotive and Refrigerant Applications

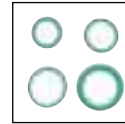

Kit Contains 270 O-Rings in a Variety of SAE Sizes



## Digital Scales

### Digital Refrigerant Scale (240 Lb. Capacity)

SKU 752521  
24560 **149<sup>99</sup>**

- High-Visibility .75" x 2.5" LCD Backlit Display
- 3 Units of Measure: Kg/Oz./Lb.
- Automatic Shut-Off After 10 Minutes, Backlight Will Shut Off After 3 Minutes
- Fully Enclosed and Removable Metal Scale Platform Enables Use of Product in or Out of the Protective Case



### Black Series Electronic Charging Scale with Bluetooth

SKU 290029  
MSC98210-BL **289<sup>99</sup>**

- Includes Bluetooth Wireless Technology
- Capacity: 243 Lb.
- Accuracy:  $\leq \pm 0.05\%$  of Reading
- Resolution: 0.05 Lb./0.5 Oz./0.01 kg
- Rugged, Non-Slip Platform



Mastercool  
World Class Quality

## A/C Flush

CPS

### A/C Flush Machine

SKU OUTSIDE BUY/EPO  
CPSAFM100

**1,599<sup>99</sup>**

- Air Operated 8' Hoses to Reach Any System
- Forward or Reverse Flush without Changing Hoses
- 2-1/2 Gallon Capacity Tank for Use on Cars and Buses
- Universal Couplers Allows Connection to Most Types of Connections
- Clear Filter Bowl Allows You to See What is Coming Out of the System with a Cleanable Filter



For Outside Buy/EPO, Call 901-300-4878

### MASTERCLEAN A/C Flush Machine

SKU OUTSIDE BUY/EPO  
MSC69900 **929<sup>99</sup>**

- Designed to Flush All HVAC/R and Automotive Systems
- Pump Power: 0.4 HP; Flow Rate: 4 Gal/Min.
- Stainless Steel Ball Valve Controls
- 1/4" SAE Connection
- Pump Equipped with Mechanical Seal and PTFE Gasket
- 110 VAC



For Outside Buy/EPO, Call 901-300-4878

### Adapter Kit

SKU 481575  
MSC69925 **134<sup>99</sup>**

- Isolates A/C System Components for Closed Loop Flushing
- Flush Individual Components without Removing Them from the Vehicle
- Install Adapters on A/C Line Ends to Allow Attachment of Flushing Equipment



### A/C Flush Kit

SKU 1103579  
37377 **49<sup>99</sup>**

- Uses Shop Air to Pressurize the Solvent to Thoroughly Clean the System
- Simple, Effective and Easy to Use
- Attached Nozzle Directs the Solvent without Sprayback
- Includes: Canister, Hose, Blowgun, Rubber Tip and Cylinder Cap
- Solvent Purchased Separately



### A/C Flush Solvent

#### Bottle (32 Oz.)

SKU 695650  
MSC91049-32 **24<sup>99</sup>**

#### 1 Gallon

SKU 695653  
MSC91049-128 **64<sup>99</sup>**



MSC91049-32

MSC91049-128

Mastercool  
World Class Quality

Prices subject to change without notice. Prices do not include applicable taxes, vehicles, tires, rims, installation or optional equipment as shown. Please do not return purchases to the store. For information regarding warranty, repair, or any questions or concerns, call 901-300-4878.

AZG0225

23

# AIR CONDITIONING

## A/C Hose and Line Repair

OEM TOOLS®

### Heavy Duty Ratcheting Hose Cutter

SKU 466311 **19<sup>99</sup>**  
24522

- Smooth Action and High Quality Blade Provide Quick, Clean and Accurate Cuts
- Ratcheting Action Makes it Faster and Easier to Use than Other Cutters
- Cuts Rubber Hose and PVC Up to 1-1/2" OD
- Wide Hooked Jaws Hold Tubing Securely



### Ratcheting Tubing Cutter

SKU 466309 **29<sup>99</sup>**  
24520

- Ratcheting Action is Ideal Where Space is Limited
- Cuts 1/4" to 7/8" Tubing
- Spare Cutting Wheel Included



## Thermometers

OEM TOOLS®

### Thermal Imaging Camera

SKU 213193 **199<sup>99</sup>**  
24552

- Temperature Range: -4°F to 1,202°F (-20°C to 650°C), Selectable Temperature (C or F)
- Captures Thermal Images and Saves to MicroSD Card (Not Included)
- 3 Selectable Color Palettes
- 1.8" LCD Color Display
- Includes Storage Pouch and Mini USB Cable



### Hand-Held Hydraulic Crimper Kit for A/C Hoses

SKU OUTSIDE BUY/EPO **349<sup>99</sup>**  
FJC2806

- Includes Complete Set of Dies
- For Hose Sizes: #6, #8, #10, #12 and Reduced Barrier Hose Sizes
- Hand-Held, Hydraulic Tool – Ideal for Shop and Field Applications
- Custom-Molded Protective Case



For Outside Buy/EPO, Call 901-300-4878

### Manual Style A/C Hose Crimper, Bench or Vise Mounted

SKU 290028 **319<sup>99</sup>**  
MSC71550

- Manual Style A/C Hose Crimper
- Mount to Bench Using Holding Fixture or Place in Vise
- Includes: 71500 - 001 Yoke Assembly, 71550 - 002 Arbor Assembly, 71550 - 003 Holding Fixture Assembly, 71500 - 6 Die Set - #6 (5/16"), 71500 - 8 Die Set - #8 (13/32"), 71500 - 10 Die Set - #10 (1/2"), 71500 - 12 Die Set - #12 (5/8") and 71500-PB Custom Mold Box Carrying Case



### Non-Contact Infrared Thermometer

SKU 951642 **34<sup>99</sup>**  
25245

- Point-and-Click Non-Contact Thermometer Uses a Laser Pointer to Give Precise Temperature Readings Ranging from -58°F to 716°F (-50°C to 380°C)
- Laser Pointer Identifies the Spot to Be Measured and Provides Accurate Temperature Measurements from a 12:1 Distance-to-Spot Ratio (Emissivity 0.95 Preset)
- Lightweight and Easy to Operate with an LCD Backlit Display That Makes it Effective Even in Low Light Situations
- Auto Power-Off Feature Conserves Battery Power by Shutting Thermometer Off After 7 Seconds of Non-Use
- 9V Battery Included (Typical Battery Life: 22 Hours in Non-Laser Mode, 12 Hours in Laser Mode)



## AirSept® Line Repair

**SAVE TIME & MONEY!**

**FIX or TERMINATE a Line in 5 MINUTES!**

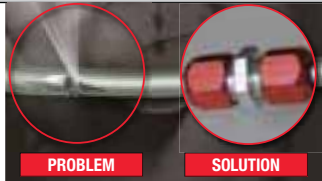

**CERTIFIED LEAK-FREE**



**UP TO 2,600 psi**

**OE-APPROVED REPAIR SOLUTION INSTALLS IN MINUTES, NO SPECIAL TOOLS, NO GLUE**

### Line Terminator SAE (5 Pack)

SKU 504122 **109<sup>99</sup>**  
AIR76526

- Quickly and Effectively Blocks A/C Lines at the Damage Point or at the Front System "Y"
- Block Off Leaking Rear Evaporators and Failed System Components
- Include One Each: 5/16", 3/8", 1/2", 5/8" and 3/4" SAE Kits



### Line Terminator SAE/Metric (10 Pack)

SKU 504124 **199<sup>99</sup>**  
AIR76530

- Quickly and Effectively Blocks A/C Lines at the Damage Point or at the Front System "Y"
- Block Off Leaking Rear Evaporators and Failed System Components
- Includes One Each: 5/16", 3/8", 1/2", 5/8", 3/4", 8 mm, 10 mm, 12 mm, 15 mm and 16 mm



### Line Splice Straight SAE/Metric (10 Pack)

SKU 504103 **284<sup>99</sup>**  
AIR76051

- Includes One Each: 5/16", 3/8", 1/2", 5/8", 3/4", 8 mm, 10 mm, 12 mm, 15 mm and 16 mm



### Line Terminator Rear A/C Blockoff Kits

- Quickly and Effectively Blocks A/C Lines at the Damage Point or at the Front System "Y"
- Block-Off Leaking Rear Evaporators and Failed System Components
- Help Maximize Front A/C Performance
- Eliminate Refrigerant and Oil Pooling in Rear A/C Lines



SKU	Part #	Size	Price
504149	AIR76502	3/8" Line	<b>26.99</b>
504146	AIR76501	1/2" Line	<b>26.99</b>
504150	AIR76503	5/16" Line	<b>26.99</b>
504152	AIR76504	5/8" Line	<b>30.99</b>
504154	AIR76505	3/4" Line	<b>35.99</b>
329221	AIR77508	8 mm OD Line	<b>26.99</b>
329219	AIR77510	10 mm OD Line	<b>26.99</b>
329231	AIR77515	15 mm OD Line	<b>30.99</b>
329230	AIR77516	16 mm OD Line	<b>30.99</b>

### Line Splice Straight Repair Kit

- High-Tech Anti-Vibration Tension Ring Ensures Durability in Tough Automotive Applications
- HNBR Seal Sleeve Dramatically Expands the Sealing Surface Area
- Burst Tested to 2,600 psi



SKU	Part #	Size	Price
504140	AIR76003	5/16" Line	<b>35.99</b>
504138	AIR76002	3/8" Line	<b>35.99</b>
504136	AIR76001	1/2" Line	<b>35.99</b>
504143	AIR76011	5/8" Line	<b>44.99</b>
504132	AIR77008	8 mm Line	<b>35.99</b>
504155	AIR77010	10 mm Line	<b>35.99</b>

### Smart Splice™ Line to Hose

- Leak-Proof Line Splice™ Technology on the Metal Side of the Connection
- Superior Hose Crimp Technology on the Rubber Side
- Also Works for Heater and Coolant Lines
- Install in 5 Minutes



SKU	Part #	Size	Price
504125	AIR76701	1/2" Line to #8 Hose	<b>35.99</b>
504128	AIR76702	3/8" Line to #6 Hose	<b>35.99</b>
OSB/EPO	AIR76704	5/8" Line to #10 Hose	<b>44.99</b>

For Outside Buy/EPO, Call 901-300-4878

Prices subject to change without notice. Prices do not include applicable taxes, vehicles, tires, rims, installation or optional equipment as shown. Please do not return purchases to the store. For information regarding warranty, repair, or any questions or concerns, call 901-300-4878.



# ALLDATA Diagnostics<sup>®</sup>

Your all-in-one scan tool solution with the power of ALLDATA built in

Turns any tablet into a pro-level scan tool

Includes VCI hardware PLUS unlimited scans

Seamless access to ALLDATA's #1 repair info

Do quick vehicle scans from your phone

**SEE IT IN ACTION**  
**(888) 726-3211**  
**ALLDATA.com**

**ALLDATA<sup>®</sup>**  
AUTOMOTIVE INTELLIGENCE<sup>®</sup>

©2025 ALLDATA LLC. ALLDATA, Automotive Intelligence, ALLDATA Repair, ALLDATA Collision, ALLDATA Diagnostics, ALLDATA Shop Manager, ALLDATA Tech-Assist and ALLDATA Mobile are registered trademarks and ALLDATA Manage and ALLDATA Community are marks of ALLDATA LLC. AutoZone is a registered trademark of AutoZone IP LLC. All other marks are property of their respective owners.

# DIAGNOSTICS

## TopDon

### 6" Bluetooth Scan Tool with Service Functions & CAN-FD

SKU **OUTSIDE BUY/EPO**  
TPDAD800BT2 **399<sup>99</sup>**

- FCA SGW Support
- 28+ Special Services for Your Productive Days
- Wider Coverage, Faster Solutions
- Cut the Cord, Work Without Limits
- All Systems Covered, All Issues Addressed
- Real-Time Performance Tracking with Live Data
- Effortless Organization, Ergonomic Excellence
- Identify, Record, and Share with Ease
- Take Advantage of the Feedback Feature to Communicate Any Issues You Encounter



For Outside Buy/EPO, Call 901-300-4878

**NEW**

### T-Ninja Pro Key Programming Via OBD2

SKU 1340225  
TPDNINJAPRO **499<sup>99</sup>**

- Pin Reading and Key Learning
- Remote Control Learning
- Deletes Keys
- All Keys Lost
- Reads and Clears Fault Codes
- Supports Wireless and Wired Dual Connectivity



**TOPDON**

### Phoenix Smart Diagnostic System

SKU 1331482  
TPDPXSMART **2,299<sup>99</sup>**

- Android Based OE-Level Coverage
- 10.1" HD Touch Screen
- TOPOLOGY Feature for Enhanced Diagnostics
- SmartLink VCI - Adds CanFD, DoIP, J2534, RP1210
- Codes/Data/Bi-Directional/Special Functions/Coding/Programming



### Phoenix Max Diagnostic System

SKU 1331492  
TPDPXMAX **4,499<sup>99</sup>**

- Includes A 4-Channel Oscilloscope
- Supports Cloud-Based Programming For 9+ Brands, Including: Mercedes-Benz, BMW, Audi, Volkswagen/Skoda/Seat, Porsche, Jaguar/Land Rover, Nissan, Subaru and Renault
- Supports 9V to 24V Vehicle Models, Configuring Both Passenger Cars and Heavy Trucks
- Heavy Duty Housing with IP65 Standards
- Auto VIN Technology Automatically Uses the Right Diagnostic Software After Identifying the Vehicle Through Its VIN



### UltraDiag 2-in-1 Diagnostic Scanner and Key Programmer

SKU 1368629  
TPDULTRIADIAG **699<sup>99</sup>**

- Full-System Diagnostics
- 8 Reset Functions: Oil, Throttle Adaptation, EPB, Steering Angle, DPF Regeneration, ABS Bleeding, BMS and Airbag
- Key Programming Functions: Number of Keys, PIN Reading, Key Learning, Remote Control Learning, Delete Keys and All Keys Lost



### Transponder and Remote Tester Tool

SKU **OUTSIDE BUY/EPO**  
TPDT-DARTS **44<sup>99</sup>**

- Allows Either USB or Battery Powered Function
- Supports Transponder Chips
- Supports 100+ Transponder Chips
- Includes: Quick Guide and a USB Type-C Cable



For Outside Buy/EPO, Call 901-300-4878

### 5" Thermal Imaging Camera Tablet

SKU **OUTSIDE BUY/EPO**  
TPDTC003 **499<sup>99</sup>**

- Superior Image Quality with an IR Resolution of 256 x 192
- Highly Accurate Temperature Readings
- Expanded Capabilities with OTG Functionality
- Optimized Testing Range



For Outside Buy/EPO, Call 901-300-4878

### SHARED SERVICE FUNCTIONS

- |                                 |                             |                                 |
|---------------------------------|-----------------------------|---------------------------------|
| Oil Reset                       | Language Change             | FRM Reset                       |
| EPB - Electronic Parking Brake  | Headlamp                    | Transport Mode                  |
| BMS - Battery Management System | CHG Tire Size               | HV Battery                      |
| SAS - Steering Angle Sensor     | Speed & PTO                 | ACC                             |
| Immo Keys - Immobilizer & Keys  | Cylinder                    | A/C                             |
| Brake Bleed                     | Trans Adaption              | Rain/Light Sensor               |
| DPF - Diesel Particulate Filter | Airbag Reset                | Reset Control Unit              |
| Injector                        | Clutch                      | CCS/ACC                         |
| Suspension                      | A/F Setting                 | VIN                             |
| Throttle                        | Resolver Sensor Calibration | Coolant/Refrigerant Change      |
| ABS/SRS                         | Automatic Start/Stop        | Sunroof Initialization          |
| VGT Learn                       | Electronic Water Pump Start | TEC learn                       |
| Relative Compression            | EGR                         | HV De-energization/Energization |
| Window / Door / Roof            |                             | All System Auto-Scan            |
| Seats                           |                             |                                 |
| Odometer                        |                             |                                 |

**MaxiCheck® MX900**  
SKU 1369200  
Part #MX900 **\$505<sup>00</sup>**



**MaxiTPMS® TS900**  
SKU 1337325  
Part #TS900 **\$795<sup>00</sup>**



	MAXICHECK MX900	MAXITPMS TS900
<b>OPERATING SYSTEM</b>	ANDROID 11	ANDROID 11
<b>SOFTWARE UPDATES</b>	1 YEAR FREE	1 YEAR FREE
<b>AUTOMATIC DETECTIONS</b>	AUTO-VIN/SCANVIN	AUTO-VIN/SCANVIN
<b>VEHICLE COVERAGE</b>	US, ASIAN & EUROPEAN 1996 & NEW	US, ASIAN & EUROPEAN 1996 & NEW
<b>OBDII TEST MODES</b>	PERFORM BI-DIRECTIONAL ACTIVE TESTS AND SPECIAL FUNCTIONS	PERFORM BI-DIRECTIONAL ACTIVE TESTS AND SPECIAL FUNCTIONS
<b>DIAGNOSTICS &amp; SERVICE</b>	ALL SYSTEMS / 40+ SERVICES	ALL SYSTEMS / 40+ SERVICES
<b>VEHICLE CONNECTIVITY</b>	CORDED	BLUETOOTH VCI
<b>TPMS DIAGNOSTICS</b>	-	INCLUDED WITH ENHANCED TPMS STATUS SCREEN
<b>TPMS SENSOR COMPATIBILITY</b>	-	AUTEL BLE SENSOR FOR TESLA + PROGRAM AUTEL MX-SENSOR 1-SENSORS

**CALL YOUR COMMERCIAL SALES MANAGER FOR CURRENT DEALS & ORDERING**

**AUTEL**

## Smoke Leak Detectors

### ReadySmoke™ Leak Detector

SKU **OUTSIDE BUY/EPO** **749<sup>99</sup>**  
RED95-0400

- Pinpoint Intake, Exhaust and Other EVAP Leaks In Minutes
- Flow Meter Identifies Minute Leaks at and Below .010" in Diameter
- Easy Fill Dipstick Style Fluid Port
- Includes: (2) 2 Oz. OEM-Approved Vapor Producing Fluid, EVAP Service Tool Kit, Halogen Inspection Light, Cap Plug Kit, Standard Cone Adapter and Storage Case



For Outside Buy/EPO, Call 901-300-4878

**REDLINE**  
DETECTION.COM



Made in USA

### Smoke Pro Air™

SKU 1340239 **1,399<sup>99</sup>**  
RED95-0075

- Ideal for Performing Diagnostics on the Evap Systems of Naturally-Aspirated Vehicles
- Features an Onboard Micro Air Compressor for Total Portability and Includes All Needed Accessories
- Uses OEM-Approved Fluid to Produce a Visual Vapor That is Free of Dyes and Contaminants
- Detects Leaks as Small as 0.010" and Performs Air Leak Decay Test



**REDLINE**  
DETECTION.COM



Made in USA

### Smoke Pro® Total-Tech®

SKU **OUTSIDE BUY/EPO** **1,099<sup>99</sup>**  
RED95-0003C

- Find ALL Types of Leaks
- Greatly Reduce Diagnostic Time
- One Simple Connection Diagnoses an Entire System in Seconds
- Eliminate Comebacks by Verifying That Leaks are Completely Repaired
- Includes Easy INTAKE™



Warranty: 2 Years  
For Outside Buy/EPO,  
Call 901-300-4878

**REDLINE**  
DETECTION.COM

### Intake Inflatable Block Off Bladder

SKU 598274 **69<sup>99</sup>**  
24536

- Conforms to Any Shape
- Intake/Exhaust: Square, Round, Oval or Rectangular
- Works with Most Automobiles and Light, Medium and Heavy Duty Trucks
- Replacement Bladder Available

**OEM TOOLS**



Use with All Smoke Machines

### EasyConnect® Test Kit

SKU 1189091 **109<sup>99</sup>**  
RED96-0190

- Forms a Complete Seal for Effective Leak Testing without Disturbing Other Components
- Comes in a Compact and Durable Storage Case
- Compatible with Any Smoke Machine
- Includes: 4 Different Sized Adapters with 4 Add-On Components



**REDLINE**  
DETECTION.COM

### Easy INTAKE™

SKU 696477 **169<sup>99</sup>**  
RED95-0082

- Compatible with Any Smoke Machine
- Block Off Bladder Conforms to Any Shape Intake/Exhaust



**REDLINE**  
DETECTION.COM



Made in USA

### Smoke Producing Fluid (8 Oz.)

SKU 802333 **29<sup>99</sup>**  
RED96-0039

- Contains No Dye or Other Contaminants
- Works in Most EVAP Smoke Machines



**REDLINE**  
DETECTION.COM



Made in USA

### EasyEVAP™ Universal Filler Neck Connector

SKU 343405 **124<sup>99</sup>**  
RED95-0030

- Compatible with Any Smoke Machine and Removes Cleanly from the Gas Cap
- Essential Tool for Late Model Cars with Fuel Tank Rollover Valves



**REDLINE**  
DETECTION.COM



Made in USA

### Digital Dual Smoke Machine

SKU **OUTSIDE BUY/EPO** **1,449<sup>99</sup>**  
MSC43066

- High-Precision Gas Pressure Sensor Ensures Accurate Data
- 3 Built-In High-Power Air Pumps, Offers Faster and Thicker Smoke Generation
- Pressure Regulated at 0.44-0.5 psi for Safe EVAP Testing, Maximum Out 20 psi for High Pressure Testing
- Accessories Include: Full Set of Block Off Caps, Schrader Valve Remover/Installer, Service Port Adapter Hose, 2 Oz. Smoke Producing Fluid and Bladder for Intake Testing



For Outside Buy/EPO,  
Call 901-300-4878

**Mastercool**  
"World Class Quality"

### Evap Diagnostic Smoke Machine

SKU **OUTSIDE BUY/EPO** **929<sup>99</sup>**  
MSC43060EV

- Multiple Options for Smoke Injection Include Built-In Internal Compressor, Shop Air and Inert Gases
- Pressure Decay Gauge 0-30" H2O (70 mbar)
- Flow Meter: 0 to 0.040" (0 to 1.0 mm)
- Input Pressure: Max. 100 psi (8.2 bar)
- Built-In Pressure Regulated at 0.5 psi



For Outside Buy/EPO,  
Call 901-300-4878

**Mastercool**  
"World Class Quality"

# DIAGNOSTICS

## Diagnostic

### Compression Tester Gauge Set

SKU 1103601 **29<sup>99</sup>**  
37138

- Use to Test Compression 0 to 300 psi on 14 mm and 18 mm Spark Plug Ports and Determine Engine Mechanical Condition



### 8 Piece Noid Light Set

SKU 1103589 **24<sup>99</sup>**  
37161

- Includes: GM TBI, GM SCPI, GM PFI, Ford TBI, GEO TBI, Bosch PFI, Bosch Type 2 and GM Multec 2
- See-Through Design to Check Electrical Pulses



### Automotive Tune-Up and Brake Bleed Kit

SKU 466495 **36<sup>99</sup>**  
25138

- Useful for a Wide Range of Fluid Extraction and Diagnostic Tasks
- Allows a Single Person to Bleed Brake Fluid
- Access Automotive Systems Under Vacuum to Check for Leaks
- Includes Hoses, Adapters and Translucent Collection Cup



### Exhaust Back Pressure Tester/Gauge

SKU 1103604 **54<sup>99</sup>**  
37263

- Oxygen Sensor Adapter is M12 and M18 Thread
- 6' Hose Allows User to Test from Driver's Seat
- Test for Restricted Exhaust Systems



### Oil Pressure Gauge Set

SKU 347229 **79<sup>99</sup>**  
27262

- For Use on Diesel and Gasoline Engines
- Includes Standard and Metric Adapters Found on Most Cars and Trucks
- 2-1/2" Easy-to-Read Gauge with Protective Boot
- Range: 0-100 psi, 0 to 7 Bar



# POWERED BY AUTEL<sup>®</sup> DIAGNOSTICS

## MaxiSYS<sup>®</sup> DIAGNOSTIC SOLUTIONS

- Most comprehensive vehicle coverage in aftermarket scan tool
- Dynamic topology module mapping for supported vehicles
- Octacore processor and 128GB-256GB memory
- Advanced VCM1 including 4-channel scope on MSULTRA and MS919
- Programming and flashing with included J2534 pass-through box (with OE subscription)
- Remote Expert allows for remote programming, flashing, and reporting capabilities



### MaxiSYS<sup>®</sup> MSULTRA

SKU 1092018 Part #MSULTRA **\$5,695<sup>00</sup>**

### MaxiSYS<sup>®</sup> MS919

SKU 1093326 Part #MS919 **\$4,745<sup>00</sup>**

### MaxiSYS<sup>®</sup> MS909

SKU 1094086 Part #MS909 **\$3,795<sup>00</sup>**

### MaxiSYS<sup>®</sup> ULTRA EV

SKU 1267097 Part #MSULTRA EV **\$6,195<sup>00</sup>**

### MaxiSYS<sup>®</sup> MS909 EV

SKU 1267098 Part #MS909 EV **\$4,295<sup>00</sup>**

	ULTRA	MS919	MS909	MS909EV	ULTRA EV
<b>REMOTE EXPERT ACCESS AND REPORT STORAGE</b>	•	•	•	•	•
<b>PROGRAMMING/FLASHING WITH OE SUBSCRIPTION OR REMOTE EXPERT</b>	•	•	•	•	•
<b>COLOR CODED MODULE TOPOLOGY ON SUPPORTED VEHICLES</b>	•	•	•	•	•
<b>VCM1 5-IN-ONE DEVICE VCI, OSCILLOSCOPE, MULTIMETER, WAVEFORM GENERATOR, CAN BUS CHECK</b>	•	•	•	•	•
<b>SPLIT SCREEN FUNCTION</b>	•	•	•	•	•



### MaxiVIDEO<sup>®</sup> MV480

SKU 1137688 Part #MV480 **\$355<sup>00</sup>**

- Record/Playback Images & Videos
- 4.1" Color LCD Display
- Dual Front and Side Cameras for Wider Viewing Angle

### MaxiVIDEO<sup>®</sup> MV460

SKU 1089243 Part #MV460 **\$255<sup>00</sup>**

- 3.5" Color LCD Display

### AutoLINK<sup>®</sup> AL549

SKU 789375 Part #AL549 **\$69<sup>00</sup>**

- Universal OBD II and ABS Code Reader
- Read & Erase Codes, View Freeze Frame and Live Data
- Supports all 10 Modes of OBD II
- Compatible with U.S., Asian, and European vehicles, 1996 & Newer



### AutoLINK<sup>®</sup> AP2500

SKU 1414288 Part #AP2500 **\$65<sup>00</sup>**

- Read/erase codes, view Freeze Frame & Live Data, perform Emissions test
- Includes Bluetooth dongle for vehicle connection. Download FREE MaxiAP Diag app
- Vehicle health check includes engine oil life, average fuel consumption, and brake pad life.
- All Systems diagnostics on first vehicle brand. Additional coverage can be added with in-APP purchase.

### AutoLINK<sup>®</sup> AL329

SKU 103946 Part #AL329 **\$34<sup>00</sup>**

- Read/Erase Engine DTCs
- One-Touch I/M Readiness /LED Indicator
- Display Live & Freeze Frame Data



### MaxiSYS<sup>®</sup> MS909CV

SKU 1174556 Part #MS909CV **\$5,450<sup>00</sup>**

- For Class 1-8 Commercial Vehicles
- Topology Mapping on Select Models
- Engine Coverage for Construction & Agricultural Vehicles



### MaxiSYS<sup>®</sup> MS906 MAX

SKU 1507706 Part #MS906MAX **\$1,595<sup>00</sup>**

- 10.1-inch professional diagnostics and service tablet
- Perform all-systems diagnostics
- Bi-directional Active Tests and Special Functions

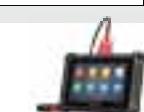

### MaxiCheck<sup>®</sup> MX900

SKU 1369200 Part #MX900 **\$505<sup>00</sup>**

- Read & Erase Codes
- Bidirectional Active Tests and Special Functions
- 40+ Function Service Menu

**\$3,895<sup>00</sup>**

### MaxiIM<sup>®</sup> IM608PROIIKPA

SKU 1336440 Part #IM608PROIIKPA

- IMMO and Key Programming Bundle
- Program IMMO & Keys for U.S., Asian & European Vehicles
- IM608PROII Tablet, XP400Pro, Wireless JVC1, IMKPA Key Programming Adapter Kit



### MaxiIM<sup>®</sup> IM508S

SKU 1442228 Part #IM508S **\$999<sup>00</sup>**

- Fast and Portable IMMO & Key Programming Tablet
- Includes the XP200 Key Programmer

### MaxiIM<sup>®</sup> KM100

SKU 1242003 Part #KM100 **\$510<sup>00</sup>**

- Advanced key and IMMO 5.5-in. touchscreen tablet with 2 iKEYS
- Program Autel's iKEY universal keys as smart key replacement for 3,000+ vehicles
- One-minute Key generation, Easy key button customization

**CALL YOUR COMMERCIAL SALES MANAGER FOR CURRENT DEALS & ORDERING**

**AUTEL<sup>®</sup>**

TEXA

### Axone Light Car Diagnostic Kit (NANO)

SKU OUTSIDE BUY/EPO **3,699<sup>99</sup>**  
TEXAXLTAKN

The Navigator NANO S can perform diagnostic operations on all major brands of cars and light commercial vehicles. It is the perfect entry level scan tool for automotive repair shops.

- Axone Nemo Light Rugged Tablet
- Navigator NANO S VCI
- IDC5m Car Software License
- Rugged Carrying Case with Custom Foam
- Motor TruSpeed Repair included



### Axone Light Car Diagnostic Kit (Multihub)

SKU OUTSIDE BUY/EPO **4,999<sup>99</sup>**  
TEXAXLTAKMH

The TXT MULTIHUB is TEXA'S flagship scan tool. It is IP53 Certified, can handle Doip, Can-FD, J2534/RP1210 protocols and more. Perfect for advanced diagnostics and shops that want the capability to work in more than one environment from the same device.

- Axone Nemo Light Rugged Tablet
- Navigator TXT Multihub
- IDC5m Car Software License
- Rugged Carrying Case with Custom Foam
- Motor TruSpeed Repair included



TruSpeed Repair



#### Both packages offer a complete diagnostics solution:

Access repair information (including torque specs, torque sequences, fluid type, capacities), read and clear codes, view live data, wiring diagrams, maintenance resets, adaptation value resets (engine, brake systems, transmission), cylinder tests, idle learning and much more.

#### WHY TEXA?

- Lifetime equipment warranty with active software subscription.
- Built by TEXA to the highest Tier 1 OEM standards.
- Secure Windows-based architecture, not Android.
- With TEXA, YOU own your data.
- Need help? You can rely on TEXA's U.S. based support team to be responsive and knowledgeable.

Try us! Call to set up a demo.

For Outside Buy/EPO, Call 901-300-4878

## ALIGNMENT WITHOUT LIMITS

DIAGNOSTICS + DIGITAL INSPECTION + ALIGNMENT + ADAS CALIBRATION

### MaxiSYS® IA900WAT Intelligent Wheel Alignment with MSULTRA Tablet

SKU 1281937  
Part #IA900WAT **\$23,219<sup>00</sup>**

- Intelligent 4-Wheel Alignment System
- AutoVIN with Pre-Scan Health Check
- Cameras automatically track vehicle height on lift

- Alignment spec coverage from 1979 to current
- Includes 24" touchscreen display and MSULTRA tablet
- Optional step by step guidance increasing workflow efficiency
- Illustrated alignment instructions, live readings, required tools, & adjustment locations

- Integrates with TPMS and tire tread depth tools
- Add-on LDW and All Systems ADAS Packages available



IA900AST PACKAGE SHOWN

### MaxiSYS® ADAS IA900WA with LDW Targets and MSULTRAADAS Tablet

SKU 1337324  
Part #IA900LDWT **\$28,146<sup>00</sup>**

- Frame capable of performing 4-Wheel alignment & ADAS calibration
- Includes ADAS Lane Departure Warning camera calibration targets
- Includes MaxiSYS ULTRAADAS wireless touchscreen tablet with Alignment and ADAS Calibration software
- Illustrated alignment instructions, live readings, required tools and adjustment locations display on a single screen

### MaxiSYS® ADAS IA900WA with All Systems Targets and MSULTRAADAS Tablet

SKU 1268177  
Part #IA900AST **\$39,966<sup>00</sup>**

- Includes same features & functions as IA900LDWT plus...
  - Includes LDW, AVM, NVS, ACC, BSD, LIDAR, and RCW targets/calibration components

### MaxiSYS® IA700 Modular ADAS Calibration Frame With Wheel Alignment pre-Check And Optical Positioning

SKU 1484478 Part #IA700T **\$20,895<sup>00</sup>**

- Includes a MaxiSYS 909, an advanced diagnostics tablet with a wireless VCI and J2534 pass-thru device that supports the latest vehicle protocols, and an ADAS calibration software upgrade card for static and dynamic ADAS calibration coverage for most U.S., Asian, and European ADAS-equipped vehicles.
- Frame features robotic crossbar and six-high definition positioning and tracking cameras for optical target positioning and prompting unlevel floor compensation.
- Frame disassembles quickly for easy transport or space-saving storage.
- Includes four tire clamps with camera targets, a steering wheel lock, brake chocks, power supply, alignment aid, and frame cover.

### MaxiSYS® IA700 Lane Departure Warning Package

SKU 1484479 Part #IA700LDWT **\$26,311<sup>00</sup>**

- Same features & functions as IA700T plus...
  - Includes Lane Departure Warning patterns and targets for calibration of Mercedes-Benz, Nissan, Infiniti, Hyundai, Kia, Toyota, Lexus, Mazda, Mitsubishi, Subaru, Volkswagen, Audi, and Alfa Romeo camera-equipped vehicles



# DIAGNOSTICS

## Multimeters and Test Kits

### Power Probe III Professional Electrical Test Kit

SKU 1330691  
PWPPROKIT01 **339<sup>99</sup>**

- Supplies Power and Ground for Functional Component Testing
- CAT-IV 600V Hybrid Safe AC/DC Voltmeter
- Measures Resistance to 60M Ohms
- Measures Current from .001 Amps to 10 Amps



**BONUS VALUE: \$84.99**

### High Power Butane Torch

PWPPBT

With Purchase of: PWPPROKIT01

Offer Good While Supplies Last Through June 30, 2025



POWER PROBE

### Power Probe III Circuit Tester

SKU OUTSIDE BUY/EPO  
PWPPP3CSRED **149<sup>99</sup>**

- Digital Voltmeter
- Continuity Tester
- 20' Jumper Lead Set
- Relay and Component Tester
- Removable Probe Tip Adapts to Any 4 mm Lead
- 2 Bright LED Lamps
- Quickly Supply Power and Ground to the Tip



For Outside Buy/EPO,  
Call 901-300-4878

### Power Probe III with Case and Accessories

SKU 262523  
PWPPP319FTC **189<sup>99</sup>**

- Relay and Component Tester
- Voltmeter and Continuity Tester
- Carbon Fiber Design Housing
- Audio Tone
- 20' Jumper Lead
- Works on 12V to 24V Sources

Other Colors  
Available on  
[AZTOOL1.com](http://AZTOOL1.com)



### Power Probe III with Lead Set

SKU 1330690  
PWPPP3LS01 **269<sup>99</sup>**

- Supplies Power and Ground
- Digital Voltmeter with Min./Max. Voltage Capturing
- 4 mm Banana Jack
- 20 Ft. Power Lead



### Power Probe IV with Case and Accessories

SKU 802331  
PWPPP401AS **309<sup>99</sup>**

- Supplies Power and Ground for Functional Component Testing
- Digital Volt and Ohmmeter for Circuit Testing
- Large Color LCD Screen with Easy to Navigate User Menu
- AC-RMS, AC Peak-to-Peak, Frequency and Pulse Width for Signal Testing
- Fuel Injector Tester for Easy Circuit Diagnosis
- PCM/ECM Driver Supplies Safe Voltage for Testing Circuits



### Power Probe® III Master Combo Kit

SKU 1105994  
PWPPPKIT03S **429<sup>99</sup>**

- Power-Up Components
- Audible Monitoring of Electrical Signals Voltmeter
- 12V to 24V Range
- Bad Ground Indicator
- Continuity Tester
- Relay and Component Tester
- Trace Short and Open Circuits



### Power Probe IV Master Kit

SKU 1330692  
PWPPPKIT04 **499<sup>99</sup>**

- Supply Power or Ground for Functional Component Testing
- Self-Resetting Thermal 8 Amp Circuit Breaker
- Multiple DC Volt Readings on the Same Display
- Quickly Determine if the Circuit is Open or is Shorted



## Reprogrammers

### Programmer and Power Supply Bundle

SKU OUTSIDE BUY/EPO  
TPDRLINKBNDL

**Simplify Your Diagnostic Process and Elevate Your Capabilities**

- Highly Compatible with OE-Level Diagnostic Software for Performing Diagnostic, Programming and Coding Tasks
- One-Click Installation of OE-Level Diagnostic Software Drivers and Online Upgrades
- ECU Programming Voltage Stabilizer
- Suitable for All Types of 12V and 24V Lead-Acid Batteries, with a Wide Battery Capacity Range from 5 to 90 Amps
- Includes: T90000 Smart Battery Charger/Power Supply, T90000 Tornado90000 9.5' DC Cable Extension and RLINKLITE J2534 Compliant Passthrough Programming Device



**1,399<sup>99</sup>**

REG. \$1,749.97

**SAVE OVER \$349**

When You Buy the Kit

For Outside Buy/EPO, Call 901-300-4878

### Smart Battery Charger/Power Supply

TOPDON®

SKU 1414398  
TPDT90000 **699<sup>99</sup>**

- ECU Programming Power Supply
- 9 Step Smart Charging with Thermal Compensation
- Charges 12V and 24V AGM, WET, GEL, MF, CAL and EFB Batteries
- Protects Against Reverse Polarities, Reverse Charges, Short Circuits, Overheating and Over-Voltages
- Current Range: 5-90 and 5-45A
- Voltage Range: 11-15.8V and 22-31.5V
- Cables: AWG18-70"



**BONUS VALUE: \$99.99**

### Tornado90000 9.5' DC Cable Extension

TPDT90DC With Purchase of: TPDT90000

Offer Good While Supplies Last Through June 30, 2025

Prices subject to change without notice. Prices do not include applicable taxes, vehicles, tires, rims, installation or optional equipment as shown. Please do not return purchases to the store. For information regarding warranty, repair, or any questions or concerns, call 901-300-4878.

## LANG

### TU-113PB Fuel Injection Pressure Tester

SKU 1330689 **89<sup>99</sup>**  
LNGTU-113PB

- Works on Most Domestic and Import Vehicles



### TU-24A-PB Three Way Exhaust and Back Pressure Kit

SKU 1331498 **179<sup>99</sup>**  
LNGTU-24A-PB

- Allows Quicker and Accurate Testing for Blockages in Catalytic Converters, Mufflers, etc.
- Test in 3 Different Access Points: Oxygen Sensor, Exhaust Pipes and Air Injection System



### TU-550 Master Fuel Injection Pressure Tester

SKU 1330693 **659<sup>99</sup>**  
LNGTU-550

- Covers All Domestic and Foreign Platforms 1988 to Present



Does Not Include Cis and TBI Adapters

## Fuel System Cleaners



### Carbon Clean 1000

SKU OUTSIDE BUY/EPO **1,959<sup>99</sup>**  
MVC500-0220

- Complete, Through the Rail, Fuel System Decarbonizing Service
- Fuel Rail Hookup Provides the Most Effective Results
- Online Application Guide
- Unique Time Saving Adapter System
- Cleans Fuel Injectors, Combustion Chamber and Intake Valves
- Works with MV5 (400-0050) Fuel System Cleaner

### MV5 Press Gas/Petrol Fuel System Cleaner 17 Oz. (6 Pk.)

SKU OUTSIDE BUY/EPO **119<sup>99</sup>**  
MVC400-0050

For Outside Buy/EPO, Call 901-300-4878



## SUR&R®

### S-Hook Sprayer

SKU 1149152 **74<sup>99</sup>**  
SURS-TOOL

- Nozzle End Produces Fine Mist Spraying Action for Thorough Cleaning of the Air Intake
- Helps Improve Fuel Performance
- Removes Carbon Build-Up
- For Use with SURFIC203



### Fuel Injection Cleaner Kit

SKU 1137808 **439<sup>99</sup>**  
SURFIC203

- Makes Connections Quickly and Easily Using S.U.R.&R.'s Exclusive Quick Connects
- Holds Up to 18 Oz. of Canister Cleaning Solution
- Cleans More Thoroughly Than Aerosol Methods
- Easy to Connect and Use with Shop Air
- For Top Engine and Throttle Body Cleaning



## New EV Tools - Contact Us for Additional EV Specialty Tools 901-300-4878

### 7 Pc. Pliers and Screwdriver Tool Set-1000V Insulated Pouch Set

SKU OUTSIDE BUY/EPO  
KNP9K989825US

**249<sup>99</sup>**

- Set Contains 4 Pliers and 3 Screwdrivers in a Roll-Up Nylon Material Pouch



### 10 Pc. Pliers and Screwdriver Tool Set, 1000V Insulated

SKU OUTSIDE BUY/EPO **299<sup>99</sup>**  
KNP9K989830US

- Set Contains 5 Pliers and 5 Screwdrivers in a Shock-Resistant Plastic Case



### 10 Pc. Socket Set, 3/8" Drive, SAE, 1000V Insulated

SKU OUTSIDE BUY/EPO **519<sup>99</sup>**  
KNP989911S3

- Includes 10 Insulated Tools for Working on Electrical Installations 3/8" Drive SAE in a Shock Resistant Plastic Case
- Foam Insert with Precise Recesses for Holding the Tools
- All Tools 100% Tested and Meet 1000V Insulated Requirements



### 15 Pc. Tool Roll Bag, 1000V Insulated

SKU OUTSIDE BUY/EPO **579<sup>99</sup>**  
KNP989913

- Includes 15 Insulated Tools for Working on Electrical Installations in a Roll Made Pouch Made of Hard-Wearing Polyester Fabric
- Pouch is Secured with a Quick Release Fastener Once Rolled Up
- All Insulated Tools Meet the Requirements of ASTM F1505



### Insulated VDE Combination Pliers

- Tested to 10,000 Volts AC for Maximum Safety
- GS/VDE Certification and Tested, Certified to 1000 VAC
- Individually Certified to EN 60900
- TPR Ergonomic Cushion Grips



TIT73328

**6"** SKU OSB/EPO **19<sup>99</sup>** **7"** SKU OSB/EPO **19<sup>99</sup>** **8"** SKU OSB/EPO **24<sup>99</sup>**  
TIT73326 TIT73327 TIT73328

### 10 Pc. Insulated Socket Set 1/4" Drive, Metric

SKU OUTSIDE BUY/EPO **169<sup>99</sup>**  
WIH31393

- Insulated 1000 Volt Rated 10,000 Volt Tested
- Meets ASTM F1505
- Professional Series Long Life Insulated
- High Visibility Coatings on Sockets
- Double Covered Insulation Red Over Yellow
- Includes: 5 mm to 14 mm



To Confirm Price, Availability and Ordering Instructions on Outside Buy/EPO, Call 901-300-4878

# DIAGNOSTICS

**Mityvac®**

## Professional Compression Test Kit

SKU 972276 **114<sup>99</sup>**  
MITMV5530

Everything You Need to Perform Cylinder Compression Tests on Motorcycles, Marine and Small Engines and an Air-Hold Adapter for Performing Valve Seal Repairs

- Adapters Include: 10 mm, 12 mm, 14 mm and 18 mm
- Extended Hoses for Hard-to-Reach Cylinders
- Large 2-3/4" Easy-to-Read Gauge
- Quick Disconnect Fittings



## Silverline Elite Test Kit

SKU 988888 **139<sup>99</sup>**  
MITMV8500

- Provides Either Vacuum or Pressure with Equal Precision and Convenience
- Performs Engine Performance Diagnostics, Brake Bleeding, Fluid Transfer, Evacuation, Sampling and More
- Includes Components Needed to Perform Hundreds of Diagnostic and Mechanical Tests



## Power Steering Adapter Kit

SKU 752069 **84<sup>99</sup>**  
MITMVA670

- Works with a Hand Vacuum Pump
- Helps Remove Trapped Air in the Power Steering System
- Includes: Universal Power Steering Adapter (MVA660), GM Power Steering Adapter (MVA661), Ford Power Steering Adapter (MVA662) Works with a Hand Vacuum Pump Helps Remove Trapped Air in the Power Steering System



## Digital Gas Engine Compression Test Kit

SKU 383182 **219<sup>99</sup>**  
MITMV5532

- Stores Maximum Compression Value for Up to 12 Cylinders
- 3 Minute Auto Shut-Off
- Sealed, Grease and Oil-Resistant Gauge Face Prevents Contamination of Electronics
- Displays Values in psi, Bar and kPa



## Diesel Digital Compression Test Kit

SKU 988885 **384<sup>99</sup>**  
MITMV5535

- Features an Electronic Tester that Memorizes Peak Values for Each Cylinder Injector Adapter
- Includes: (2) Injector Adapters and (4) Glow Plug Adapters for Testing Most Modern Diesel Cars and Light Trucks Sold in the U.S.



## Ford 6 Liter Adapter

SKU 972279 **49<sup>99</sup>**  
MITMVA5610

- Glow Plug Adapter - M14 x 1.25
- International VT365
- Ford Power Stroke, 6.0 Liter Engine



**INNOVA®**

## OE-LEVEL DIAGNOSTIC TOOLS US-BASED SUPPORT

### RepairSolutionsPRO

INNOVA®  
DIAGNOSTIC TOOL  
SDS43  
SKU#1062521

- FREE access to RSPRO Built-in
- Secure Gateway access on 2018 & newer FCA vehicles



Contact commercial sales manager for pricing.

STORE STOCKED

- OEM/Enhanced Diagnostics
- Active Tests and Special Functions
- Removeable VCI - Wireless Diagnostics

POWERED BY  
**REPAIR SOLUTIONS PRO**  
Automotive repair database with verified fixes and repair tips.

### RepairSolutionsPRO

INNOVA®  
DIAGNOSTIC TOOL  
SDS50  
SKU#1269649

- FREE access to RepairSolutionsPRO
- All Systems Scan



Contact commercial sales manager for pricing.

STORE STOCKED

- Service Check and Warning Light
- OEM Level DTCs + Live Data
- Active Tests and Special Functions

POWERED BY  
**REPAIR SOLUTIONS PRO**  
Automotive repair database with verified fixes and repair tips.

### RepairSolutionsPRO

INNOVA®  
DIAGNOSTIC TOOL  
SDS43  
SKU#1269650

- FREE access to RepairSolutionsPRO
- Multiple Report Types



Contact commercial sales manager for pricing.

STORE STOCKED

- Service Check and Warning Light
- Bi-Directional / Active Tests + Special Functions
- OEM Level DTCs + Live Data

POWERED BY  
**REPAIR SOLUTIONS PRO**  
Automotive repair database with verified fixes and repair tips.

### RepairSolutions2

INNOVA®  
DIAGNOSTIC TOOL  
5160RS  
SKU#1009353

- Bi-Directional / Active Tests
- Steering Angle Reset
- Vehicle Network Scan
- Electronic Parking Brake Assist
- Oil Light Reset



POWERED BY  
**REPAIR SOLUTIONS 2**

Find the right fix and get the right parts instantly.

INNOVA® 2.8" LCD INSPECTION CAMERA  
3381  
SKU#1392578

- Record video and audio
- 8 Bright Illumination LEDs
- IP67 Rated Submersible Lens allows safe inspection of areas contaminated by oil or water



Accessories Included:  
Magnet, Hook and Mirror



Contact commercial sales manager for pricing.

STORE STOCKED

INNOVA® INFRARED THERMAL IMAGING CAMERA  
3361  
SKU#1407324

- Target & record temperatures and thermal data with advanced infrared technology
- Easily inspect vehicle cooling systems, HVAC, brakes and more
- Built-in flashlight and laser



Contact commercial sales manager for pricing.

STORE STOCKED

INNOVA® AUTOMOTIVE DIGITAL MULTIMETER  
3340  
SKU#94874

- Tests alternators, diodes, solenoids, breaker points, wiring, switches and more
- 10 MegOhm impedance prevents damage to ECU
- Measure RPM, Dwell, Frequency, Temperature, Pulse Width, Duty Cycle
- Accessories Included



Contact commercial sales manager for pricing.

STORE STOCKED

INNOVA® COMPRESSION TESTER PLUS  
3614  
SKU#273351

- Universal direct shaft
- 15" high-pressure S.S. hose with 14mm & 18mm fittings
- Side-release valve
- Large, 2-1/2" dial face
- 10mm, 12mm and 14mm long reach adaptors



Contact commercial sales manager for pricing.

STORE STOCKED



# GREASE GUNS

TO ORDER, contact your Commercial Sales Manager or go to [AutoZonePro.com](http://AutoZonePro.com)

GREASE GUNS

## Grease Guns

- Cast Iron Pump Head for Added Strength and Durability
- Multiple Filling Options to Support Suction, Filler and Cartridge Loading
- Precision Fit Plunger Prevents Grease Bypass and Resists Scoring
- Heavy Duty Follower Spring Allows Easy Priming and Efficient Pumping

**OEM TOOLS**



Mini Pistol with Extension	Mini Lever Action	Lever Action Clear	Lever Action	Pistol Grip with 18" Extension Hose	Pneumatic with 18" Extension Hose
SKU <b>1207892</b> 87207	SKU <b>1207896</b> 87206	SKU <b>1207899</b> 87204	SKU <b>1362012</b> 87201	SKU <b>1207888</b> 87203	SKU <b>1207901</b> 87205
<ul style="list-style-type: none"> <li>• Includes 6" Extension</li> <li>• 2,900 Max. psi</li> </ul>	<ul style="list-style-type: none"> <li>• 4,000 Max. psi</li> </ul>	<ul style="list-style-type: none"> <li>• Includes 7" Extension</li> <li>• 10,000 Max. psi</li> </ul>	<ul style="list-style-type: none"> <li>• Includes: 6" Steel Extension</li> <li>• 7,000 Max. psi</li> </ul>	<ul style="list-style-type: none"> <li>• Pistol Grip Handles Supports One Handed Operation</li> <li>• 6,000 Max. psi</li> </ul>	<ul style="list-style-type: none"> <li>• Includes 5.5" Extension</li> <li>• Air Operated for Continuous Lubrication Flow</li> <li>• 6,000 Max. psi</li> </ul>
<b>19<sup>99</sup></b>	<b>19<sup>99</sup></b>	<b>29<sup>99</sup></b> REG. \$39.99 Offer Good Through June 30, 2025	<b>19<sup>99</sup></b>	<b>34<sup>99</sup></b>	<b>39<sup>99</sup></b>

## Grease Gun Accessories

### 7 Piece Grease Gun Accessory Kit

SKU **978118** **44<sup>99</sup>**  
25711

- Includes: Press-On 90° Lube Tool, Straight Extension, 300 mm Hose Extension, Slide-On 90° Coupler, Rubber Tip Nozzle, Needle Nozzle and 60° Coupler



### Extension Hoses with Spring Guard

- Premium Grease Hoses for Manual and Air-Operated Grease Guns
- Spring Guard for Added Rigidity to Prevent Kinking
- Max. Working Pressure: 4,500 psi
- Burst Pressure: 12,000 psi
- Accessory Thread: 1/8" NPT



**12"** SKU **1207902** **9<sup>99</sup>** **18"** SKU **1207887** **10<sup>99</sup>** **36"** SKU **1207893** **11<sup>99</sup>**  
87220 87221 87222

### 70 Piece Grease Fitting Assortment

SKU **577685**  
25752

**17<sup>99</sup>**

- 70 Assorted Grease Fittings in 6 Popular Sizes



### Bearing Packer

SKU **1055505** **18<sup>99</sup>**  
26540

- Quickly Flushes Out Old Grease and Repacks Bearings with New Grease
- Transparent, Impact Resistant Cup Allows User to Clearly See Grease Level
- Works on Bearings with Up to 3-1/2" Outside Diameter



### Universal Bearing Packer

SKU **1339731** **13<sup>99</sup>**  
25081

- Connects to Any Grease Gun
- Services Most Roller and Ball Bearings
- Forces Out the Old Grease and Evenly Injects Fresh Grease



## Lincoln

### 20V Li-ion PowerLuber Kit

SKU **751676** **499<sup>99</sup>**  
LIN1884

- Delivers Grease at Up to 10,000 psi
- Built-In LED Illuminates the Work Area
- Includes: Grease Gun, 2 Batteries, Charger and Case
- 36" Flex Hose



### 12V Li-ion PowerLuber Kit

SKU **605324** **354<sup>99</sup>**  
LIN1264

- Li-ion Battery for Maximum Power and Efficiency
- Delivery at Up to 8,000 psi
- Built-In LED Illuminates Dimly Lit Areas
- 30" Grease Hose



### Fully Automatic Pneumatic Grease Gun

SKU **445386** **169<sup>99</sup>**  
LIN1162

- Fully Automatic, Continuous Operation
- 30" High-Pressure Hose with Coupler and Attachment Clip
- Pump Ratio: 40:1 at 150 psi
- Max. Grease Pressure: 6,000 psi



### Super Pistol Grip

SKU **445385** **89<sup>99</sup>**  
LIN1134

- 18" Whip Hose
- Includes Rigid Pipe
- Variable Stroke Design
- 7,500 psi
- Filler Nipple/ Bleeder Valve



### Professional Lever Grease Gun with 18" Whip Hose and Coupler

SKU **522903** **74<sup>99</sup>**  
LIN1147

- 3-Way Loading: By Cartridge, Bulk Load and Suction Load



Prices subject to change without notice. Prices do not include applicable taxes, vehicles, tires, rims, installation or optional equipment as shown. Please do not return purchases to the store. For information regarding warranty, repair, or any questions or concerns, call 901-300-4878.

AZG0225

# FLUID HANDLING

## Fluid Extractors

Change fluids quickly and easily anytime. No mess, no clean up.  
Simply remove the dipstick and insert the tube.



All OEMTOOLS Fluid Extractors Include:



Quick Connect



Automatic Shut Off Valve Prevents Overfilling



No Leaks - Solid One-Piece Tank

- Single Piece Reservoir Structure Features a Leak Proof Bottom
- Overflow Shut Off Valve Prevents Fluid from Overflowing
- Use to Extract Most Fluid Types: Engine Oil, Transmission Fluid, Gear Oil, Coolant and Power Steering Fluid
- Updated 41" Extended Dipstick Hose Adapter for Longer Reach and Broader Applications

### Manual Fluid Extractors

- Reservoir with Hand Operated Pump to Tackle Big Jobs



Manual Function



2.1 Gallons (8.4 Qts.)

SKU 666877 24936 **99<sup>99</sup>**

2.5 Gallons (10 Qts.)

SKU 547010 24937 **109<sup>99</sup>**

### Pneumatic/Manual Fluid Extractors

- Working psi: 85; Max. psi: 120
- Air Consumption: 6.5 CFM



Pneumatic or Manual Function



1.5 Gallon (6.3 Qts.)

SKU 666978 24937 **89<sup>99</sup>**

2.5 Gallon (10 Qts.)

SKU 666881 24938 **119<sup>99</sup>**

### Brake Bleeder Adapter Hose for Fluid Evacuators

SKU 568479 24446 **17<sup>99</sup>**

- Use with OEMTOOLS Fluid Evacuators, Converting Them into One-Person Vacuum Brake or Hydraulic Clutch Bleeders
- Universal Bleed Screw Adapter



### Main Suction Hose Replacement

SKU 1442592 24938-1 **44<sup>99</sup>**

- Replacement for OEMTOOLS 24938, 24937, 24397, 24389 and 24936



### Replacement Dipstick and Tube Adapters

SKU 1442595 24938-2 **29<sup>99</sup>**

- 1/4" x 17" PVC Hose



SKU 1442583 24938-3 **39<sup>99</sup>**

- 1/4" x 41" Nylon Hose



## Fluid Evacuators

### PneumatiVac Fluid Evacuator (2.3 Gallon)

SKU 497203 MITMV7300 **174<sup>99</sup>**

- Operates on Compressed Air
- Independent Air Shut-Off Valve



### Fluid Evacuator Plus

SKU 497200 MITMV7201 **184<sup>99</sup>**

- Evacuates or Dispenses at the Push of a Button
- Integrated 2.3 Gallon (8.8 Liter) Capacity Reservoir
- Durable, Chemical Resistant Polyethylene Construction
- Dipstick Tube Adapters Included



### Fluid Evacuator (1.9 Gallon)

SKU 594882 MITMV7400 **149<sup>99</sup>**

- Integrated 1.9 Gallon (7.3 Liter) Capacity Reservoir
- Evacuates All Kinds of Fluids Including Engine Oil, Transmission Fluids, Gear Oil, Coolant, Brake Fluid and More



## Fluid Extractors and Fillers



### 1.5 L Fluid Extractor/Dispenser

SKU 606541 MITMVA6852 **74<sup>99</sup>**

- Simple Manual Syringe-Type Action Quickly and Cleanly Extracts or Dispenses Fluid
- Integrated Valve and Cap to Prevent Spills and Leaks
- Compact, Streamlined Design Allows Access into Tight Spaces
- Ideal for Evacuating or Topping Off Fluid Reservoirs
- Easy to Clean; Hose and Seals are Simple to Replace



### 1.5 L Fuel Extraction Syringe

SKU OUTSIDE BUY/EPO MITMVA6853 **99<sup>99</sup>**

- Ideal for Evacuating or Priming Diesel Fuel Systems
- 2 Adapter Hoses: 10 mm Male to 3/8" or 5/16" Female Fuel System Connections
- 3 Male-to-Male Adapters: 10 mm Male to a Barbed, 3/8" or 5/16" Male Connection

For Outside Buy/EPO, Call 901-300-4878



### Manual Fluid Extractor and Filler (7 Oz./.21 Qt/200 mL)

SKU 666326 24985 **9<sup>99</sup>**

- Used to Extract and Refill Many Common Automotive Fluids, Including Brake Fluid
- Dual Scale Molded into Cylinder Body (Qt./mL)
- Includes Extension Tube for Accessing Hard-to-Reach Filler Necks and Reservoirs

### 500 CC Extraction and Filling Pump

SKU OUTSIDE BUY/EPO 25572 **29<sup>99</sup>** **NEW**

For Outside Buy/EPO, Call 901-300-4878



### Fluid Siphon Pump

SKU 568475 24863 **29<sup>99</sup>**

- Transfer Fluids Easily Use to Transfer Gas, Water, Oil and Other Non-Corrosive Liquids
- Hose Reach: 6' with 1/2" Diameter



### Transmission Fluid Fill Adapter

SKU 1125880 25740 **18<sup>99</sup>**

- Required Tool to Fill or Add Fluid to the 5R55W Automatic Transmission
- Used in Many Ford Vehicles (2003 - Newer) Same as Ford No. 307-437



## Fluid Management



### Manual ATF Filler System

SKU 526508 **99<sup>99</sup>**  
24441

- Complete System for Servicing Sealed Automatic Transmissions
- Includes Adapters to Fit Ford, BMW, Honda, Nissan, VW, Porsche, Mini Cooper, Audi and Mercedes-Benz Transmissions
- Reservoir Capacity: 3 Liters (3.1 Quarts)
- Fluid Dispensing Hose Features a Swivel Connector and Fluid Dispensing Shut-Off Valve
- Comes with Belt Attachment for Storing All of the Adapters on Dispenser
- Adapters Included:  
DSG M24 x 1.5,  
CVT M22 x 1.5,  
CVT M12 x 1.5,  
ATF M10 x 1.0,  
ATF 1/8 NPT - 27,  
ATF 04, ATF 03  
and ATF 02



### ATF Refill Kit, 5 L

SKU 265092 **489<sup>99</sup>**  
MITMV6410A

- Fluid is Dispensed Under Pressure for Smooth Continual Flow
- Integrated Manual Pump Adds Air Above the Fluid Level to Prevent Aeration
- Internal Pump Components are Sealed Against Exposure to Fluids
- Flow Control Valve is Conveniently Located Near Fluid Output
- Features Integrated Safety and Manual Pressure Relief Valve



### Pneumatic ATF Refill Kit, 10 L

SKU 1330680 **519<sup>99</sup>**  
MITMV7412

- Utilizes Compressed "Shop-Air" to Produce Pressure for Fluid Dispensing



### ATF Refill Adapters with Hose

SKU 1361999 **259<sup>99</sup>**  
MITMV7216A

Quickly Converts the Mityvac MITMV7201 Fluid Evacuator Plus into a Professional Tool for Refilling Sealed Automatic Transmissions

- 13 Quick-Change ATF Refill Adapters Fit Most Vehicle Transmissions



### Gear Oil Dispenser Bottle and Tubing Kit

SKU OUTSIDE BUY/EPO  
MITMVA577

**224<sup>99</sup>**

- 10 Liter Gear Oil Dispense Bottle with Low Restriction Hose, Valve and Nozzle
- Bottle and Dispensing Equipment Included with Most Automotive Fluids (Except DEF)
- Fluid Level Indications on Reservoir to Monitor Fluid Levels
- Compatible with MV7100 and MV6400 Lids
- 10 Liter Reservoir for Larger Dispensing/Longer Refill Intervals
- Compressed Air Moves Fluids-Reduces Risk of Contamination

For Outside Buy/EPO,  
Call 901-300-4878



### Pneumatic Powered Gear Oil Dispenser

SKU OUTSIDE BUY/EPO  
MITMV7454

**429<sup>99</sup>**

- 10 Liter Pneumatic Pump Gear Oil Dispense Bottle with Low Restriction Hose, Valve and Nozzle
- Powered by Compressed Air
- 10 Liter Reservoir for Larger Dispensing/Longer Refill Intervals
- Can be Pressurized and Disconnected from Compressed Air Source for Convenience
- Easily Replaceable Tubing for Repair or Customization of Unit to Job Requirements

For Outside Buy/EPO,  
Call 901-300-4878



### Hand Pump Powered Gear Oil Dispenser

SKU OUTSIDE BUY/EPO  
MITMV7455

**324<sup>99</sup>**

- 10 Liter Hand Pump Gear Oil Dispense Bottle with Low Restriction Hose, Valve and Nozzle
- 10 Liter Reservoir for Larger Dispensing/Longer Refill Intervals
- Hand Pump Supplies Compressed Air to Power Unit
- Manual Pump to Compress Air; Nothing but Pressurized Air Moves Fluid which Lessens Risk of Contamination
- Fluid Level Indications on Reservoir to Monitor Fluid Levels

For Outside Buy/EPO,  
Call 901-300-4878

**NEW**



### Universal Fluid Dispensing System

SKU 265093 **249<sup>99</sup>**  
MITMV6400

- Large 1.2 Gallon (5 Liter) Fluid Capacity
- Integrated Manual Pump Adds Air Above the Fluid Level to Prevent Aeration
- Pressure Gauge Indicates Fluid Dispensing Pressure
- Safety and Manual Pressure Relief Valve
- Vehicle Adapters Not Included



### Dispensing Hose Assembly

SKU OUTSIDE BUY/EPO  
MITMVA595

- Replacement Hose for MITMV7454, MITMV7455 and MITMVA577

For Outside Buy/EPO, Call 901-300-4878



**NEW**

### Great for Use with Generators



### Battery-Operated Liquid Transfer Pump

SKU 1414413 **26<sup>99</sup>**  
87230

- Move Liquids Safely and Easily with this Convenient Handheld Pump
- Use in Garage, Aquariums, Home and Yard
- Pumps Up to 6 Quarts of Liquid per Minute
- Battery Operated (2 "D" Batteries)



# FLUID HANDLING

## Lever Action Pumps

**OEM TOOLS**

### Lever Action Hand Oil Pump

SKU 462495 24381 **29<sup>99</sup>**

- Oil Pump for Use with Oil-Based Fluids, Heating Oils, Motor Oils, Heavy and Light Oils, Diesel and Kerosene
- Built-In 1-1/2" and 2" Bung for Use on 16 to 55 Gallon Drums with Either Opening
- Not for Gasoline or DEF

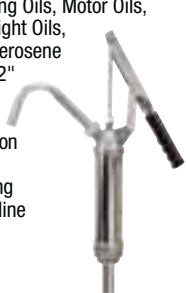

**OEM TOOLS**

### Lever Action Barrel Pump - Polypropylene

SKU 688036 24471 **39<sup>99</sup>**

- Lever Action Pump, Self-Priming
- Ideal for Diesel, Kerosene, Lubricants and Other Oils
- Not for Gasoline, Water Based Chemicals or DEF
- Maximum Flow Rate: 12 Oz. per Stroke
- Maximum Viscosity: 40 Wt. Oil

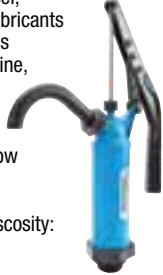

**OEM TOOLS**

### Lever Action Barrel Pump Polypropylene Stainless Steel Rod

SKU 688038 24472 **39<sup>99</sup>**

- Ideal for Pumping Diesel, Oils, Kerosene, Water-Based Chemicals, Bases and Mild Acids
- Not for Gasoline or DEF



**OEM TOOLS**

### Lever Action Barrel Pump - Ryton® Stainless Steel Rod

SKU 688037 24473 **49<sup>99</sup>**

- Ideal for Pumping Diesel, Oils, Kerosene, Water-Based Chemicals, Bases and Acids Including DEF
- Not for Gasoline

**DEF COMPATIBLE**



**LINCOLN**

### Lever Action Barrel Pump

SKU 970530 LIN1340 **99<sup>99</sup>**

- Pumps Non-Corrosive Fluids, Not for Gasoline
- Telescoping Tube for 16 to 55 Gallon Drums
- Removable Non-Drip Spout Allows for Threaded Hose Connection



## Rotary Pumps

**OEM TOOLS**

### Rotary Barrel Pump

SKU 462486 24382 **39<sup>99</sup>**

- Fluid Transfer Pump for Use with Oil-Based Fluids, Heating Oils, Motor Oils, ATF, Diesel and Kerosene
- Not for Gasoline or DEF



**OEM TOOLS**

### Polypropylene Rotary Drum Pump

SKU 688035 24470 **89<sup>99</sup>**

- Ideal for Pumping Diesel, Oils, Kerosene, Water-Based Chemicals, Bases and Mild Acids
- Not for Gasoline or DEF



### Manual Rotary Oil Pump with Hose for 55 Gallon Drums

SKU 265089 LIN1385H **344<sup>99</sup>**

- Includes: 8 Ft. x 3/4" Anti-Static Hose with Non-Sparking Aluminum Nozzle with Hanger; Seal Tight Telescoping Pick-Up Tube with Strainer for 16 to 55 Gallon Drums with 2" Bung



**LINCOLN**

### Manual Rotary Fuel Pump with Hose for 55 Gallon Drums

SKU 265088 LIN1387 **384<sup>99</sup>**

- 3 Vane Manual Rotary Pump for Most Fluid Types Including Gasoline, Diesel, Kerosene, Coolant, Non-Corrosive Materials, Medium Viscosity Petroleum Based Fluids, Hydraulic Oils and ATF



**LINCOLN**

### Manual Rotary Pump for 55 Gallon Drums

SKU 462977 LIN1385 **259<sup>99</sup>**

- Hose Not Included

Drum Not Included

## Drum Wrench

**OEM TOOLS**

### Aluminum Drum Bung Wrench

SKU 1267963 22664 **29<sup>99</sup>**

- Comfortable and Textured Grip for Ease of Use
- Non-Sparking, Non-Corrosive Aluminum Construction
- Fits Most Steel and Plastic Caps, Including 3/4" Vent Plugs
- Effortlessly Opens and Tightens Bungs to Guarantee Drum Contents are Safe
- Opens 10, 15, 20, 30 and 55 Gallon Barrels



## Fuel Transfer Pump

**JohnDow Industries**

### 25 Gallon Steel Gas Caddy

SKU 360585 DOWFC25GC **749<sup>99</sup>**

- UL Approved
- 25 Gallon Tank is Constructed of 14" Gauge Steel for Use with Unleaded Gasoline, Kerosene, Ethanol E85, Diesel and Bio-Diesel Fuels



## DEF Pump

**LINCOLN**

### Lift Action Pump

SKU 1142361 LIN1390 **144<sup>99</sup>**

- Transfers Popular Shop Fluids Including Acetone, Antifreeze, Windshield Washer, Thinners and More
- Includes NPT and Buttress Threads for Steel and Plastic Drums
- Adjustable Bung Type Fits 15, 16, 30 and 55-Gallon Drums
- Welded Ground-Post for Safe Dispensing of Volatile Fluids
- Premium Grade 316 Stainless Steel
- Self-Priming

**DEF COMPATIBLE**



## Grease Pump

**LINCOLN**

### Manual Gear Lube Dispenser

SKU 174166 LIN1293 **149<sup>99</sup>**

- 5' Hose, 13" Pump Tube
- Fits 25 to 50 Lb. 5 Gallon Containers
- Delivers 1 Oz. per Stroke



# FLUID HANDLING

TO ORDER, contact your Commercial Sales Manager or go to [AutoZonePro.com](http://AutoZonePro.com)

FLUID HANDLING

## Fluid Exchangers

**MAHLE**

### ATX280 Trans Fluid Exchange Unit

SKU OUTSIDE BUY/EPO MSS4008002300 **5,799<sup>99</sup>**

- 7" Touchscreen LCD Display with Graphical Interface
- Onboard Additive Tank for Detergent/Oil Injection



Fluid Not Included

### Trans-Tech 4 Plus

SKU OUTSIDE BUY/EPO MVC500-1125B

**MOTORVAC**  
**5,249<sup>99</sup>**

- Automatic, In-Line Exchange Through Vehicle Cooler Line
- ATF Exchange Through Vehicle Transmission Dipstick
- Drain Pan Feature
- 26 Quart New Fluid Reservoir
- High Volume Pump for Rapid and Efficient Service
- Comes with Standard Set of Adapters
- Uses MVC400-0137 2-Part ATF Cleaner and Conditioner Fluid



Fluid Not Included

### BFX-10 Brake Fluid Exchanger

**MAHLE**

SKU OUTSIDE BUY/EPO MSS4258001600 **1,249<sup>99</sup>**

- Suitable for ABS, ESP, EDS and SBC
- Hydraulic Pump
- Two Universal Adapters Included



Fluid Not Included

### BFX-20 Brake Fluid Exchanger

**MAHLE**

SKU OUTSIDE BUY/EPO MSS4258001400 **2,449<sup>99</sup>**

- Hydraulic Pump
- Suitable for ABS, ESP, EDS and SBC
- Adapters Included



Fluid Not Included

## Lube Tech Set

**OEM TOOLS**

SKU 227302 | 24965

**1,699<sup>99</sup>** REG. \$2,262.20

### Includes 160 of the Most Common Tools in Tool Cart

- SAE and Metric, 1/4", 3/8" Drive Tools, Combination Wrench Sets, Pliers and Screwdrivers. Plus Battery Service Tools, Oil Change Tools and More

**SAVE \$562**



Cart Style and Color May Vary

Offer Good Through June 30, 2025

To Confirm Price, Availability and Ordering Instructions on Outside Buy/EPO Call 901-300-4878

## Oil and Grease

### Lynx 3:1 Universal Stub Pump

SKU OUTSIDE BUY/EPO BAL1110-007 **414<sup>99</sup>**

- Reliable Air Motor Design that Features Corrosion Resistant Materials
- Double-Acting Pump Design for Smooth and Accurate Fluid Delivery
- Includes: 2" Bung-Adapter



### Oil Control Handle with Digital Meter

SKU 1485049 BAL3330-159 **314<sup>99</sup>**

- Exclusive "Memory" Flex Enables the Extension to Bend Into Any Desired Shape
- Replaceable Electronic Circuit Board and Face Plate
- Ergonomically Designed Grip Handle Reduces Fatigue for Technicians



**Balcrank**  
Fluid Dispensing Systems

### 50' EVO Reel, Lynx 5:1 HD Pump, 275 Gal

SKU OUTSIDE BUY/EPO BAL1135-017 **3,879<sup>99</sup>**

- Double Wall Construction
- UL 2258 Certified
- Compatible Fluids: DEF, Diesel and Lubricants
- Compact Design
- Package Assembled from Factory



### 5:1 HD Oil Pump Drum Package

SKU OUTSIDE BUY/EPO BAL1131-069 **2,229<sup>99</sup>**

- Reliable Air Motor Design that Features Corrosion Resistant Materials
- Includes: Heavy-Duty Drum Cart with Semi-Pneumatic 10" Tires, Front Caster with Brake to Steady Cart While in Use, 50' x 1/2" Hose Reel and Electronic Metered Handle



Drum Not Included

### Lynx 55:1 Pump Package

SKU OUTSIDE BUY/EPO BAL1151-036 **1,249<sup>99</sup>**

- Reliable Air Motor Design that Features Corrosion Resistant Materials
- Double-Acting Pump Design
- Optional Hose Reel Mounting Kit



Drum Not Included

Inside View

Prices subject to change without notice. Prices do not include applicable taxes, vehicles, tires, rims, installation or optional equipment as shown. Please do not return purchases to the store. For information regarding warranty, repair, or any questions or concerns, call 901-300-4878.

AZG0225

# OIL CHANGE

## Oil Drains

**LINCOLN**

### 18 Gallon Rolling Oil Drain

SKU 988882 **389<sup>99</sup>**  
LIN3601

- All Steel Design Includes Reinforced Caster Supports
- 14" Telescoping Bowl: Range of 45" to 72"
- Preset Air Regulator (Up to 150 psi)
- Pressurized Self-Evacuation Feature Requires Only Shop Air and a Tire Chuck to Discharge Fluids



### 25 Gallon Used Fluid Combo Drain/Evacuator

SKU 543345 **824<sup>99</sup>**  
LIN3639

- Powerful Compressed Air Operated Venturi Vacuum Quickly Draws Fluids from Reservoirs
- Includes: Mercedes-Benz, BMW and VW Dipstick Tube Adapters and 6 Evacuation Wands of Varying Flexibility, Diameter and Length
- Pressurized Self-Evacuation Feature Requires Only Shop Air and a Tire Chuck to Discharge Fluids
- Min. Height: 60"
- Max. Height: 74"



### 25 Gallon Used Fluid Evacuator

SKU 543344 **634<sup>99</sup>**  
LIN3637

### 25 Gallon Used Fluid Gravity Drain

SKU 543350 **759<sup>99</sup>**  
LIN3635

**LINCOLN**

### 18 Gallon Rolling Oil Drain

SKU 667005  
87042

**299<sup>99</sup>**

- Pressurized Self-Evacuation Feature Requires Only Shop Air
- Funnel Capacity: 2.6 Gallons
- Funnel Diameter: 17"
- Min. Height: 44.5"
- Max. Height: 68.5"



**OEM TOOLS**

### 21 Gallon Oil Drain Vacuum and Extractor

SKU 546658 **599<sup>99</sup>**  
24862

- Designed for the Collection of Used Fluids from Lift Mounted Vehicles or by Evacuation Directly from Fluid Reservoirs or Dipstick Tubes
- Funnel Diameter: 15"
- Funnel Extension Adapter: 22"
- Funnel Height Adjustment: 45" to 62"
- Includes 5 Extraction Tubes: 7 mm x 35"; 6 mm x 29"; 6 mm x 23"; 6 mm x 22" and 3/8" x 15"



### 9 Gallon Upright Portable Oil Drain

SKU 908386 **139<sup>99</sup>**  
87032

- Adjustable Drain Height: 32" to 62"
- Funnel Diameter: 17"
- Features Built-In Drain Valve and Evacuation Spout
- 4 Heavy Duty Casters for Easy Transport
- Includes: Tool Holder



Tool Tray



Easily Pour Out Used Oil



**OEM TOOLS**

### 18 Gallon Upright Portable Oil Drain

SKU 908388 **199<sup>99</sup>**  
87031

- Adjustable Drain Height: 54" to 70"
- Funnel Diameter: 18"
- Features Built-In Drain Valve and Evacuation Spout
- 4 Heavy Duty Casters for Easy Transport
- Includes: Tool Holder



Tool Tray



Drain Valve



**OEM TOOLS**

### 21 Gallon Waste Oil Drain

SKU 544817 **415<sup>99</sup>**  
24861

- Pressurized Self-Evacuation Feature Requires Only Shop Air
- Large Diameter Funnel Includes a Removable Filter Screen and Wide-Mouth Extension
- Funnel Diameter: 15"
- Funnel Extension Diameter: 22"
- Funnel Height Adjustment: 45" to 62"



Large Funnel

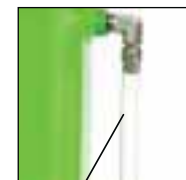

Sight Tube Catches Fluids without Spills



**BONUS VALUE: \$19.99**

### Mini Lever Action Grease Gun

87206

With Purchase of:  
87032

Offer Good While Supplies Last Through June 30, 2025



Prices subject to change without notice. Prices do not include applicable taxes, vehicles, tires, rims, installation or optional equipment as shown. Please do not return purchases to the store. For information regarding warranty, repair, or any questions or concerns, call 901-300-4878.

# OIL CHANGE

TO ORDER, contact your Commercial Sales Manager or go to [AutoZonePro.com](http://AutoZonePro.com)

OIL CHANGE

## Used Fluid Drains



### 23 Gallon Anti-Freeze Drain

SKU 1485042  
BAL4110-025 **849<sup>99</sup>**

- Powder-Coated Green
- 3/4" Cam-Lock Fitting



- All-Steel Tank and Base
- Easy-to-Use Patented Cantilever Mechanism

Premium Drains Capture Used Fluids and Transfer Them to Any Bulk Storage Tank Using a Cam-Lock Kit and Evacuation System

### 23 Gallon Oil Drain

SKU 1485039  
BAL4110-024 **849<sup>99</sup>**

- Powder-Coated Black
- 1" Cam-Lock Fitting



## Oil Change Kit



### Oil Change Lube Tech Kit

SKU 1169108 | 68916

- Includes: Oil Filter Wrench Pliers, Oil and Transmission Funnel, 3-Legged Oil Filter Wrench, 10L Oil Jug, Drain Plug Socket Set, Professional Swivel Oil Filter Wrench Kit (Fits Sizes 2-3/8" to 4-3/8"), Safety Glasses, 18 Gallon Upright Portable Oil Drain and 10 Piece Metric Cap Wrench Set



18 Gallon Oil Drain



**299<sup>99</sup>**  
REG. \$393.91

**SAVE OVER \$93**

When You Buy the Kit

## Accessories

Prevents Splashing of Hot Oil



### Oil Drain Splash Pads

- Keeps Work Areas Clean While Changing Transmission or Other Oils
- Allows Hot Oil to Drain Through Porous Pad

#### 15" Round

SKU 1340218  
SHA73850

**19<sup>99</sup>**



#### 22" Square

SKU 1340219  
SHA73851

**24<sup>99</sup>**



Drains Not Included. Not for Coolants or Fluids That Will Be Recycled in the Vehicle

### Super Transmission Drain Funnel



SKU 291377  
LIS17902 **84<sup>99</sup>**

- Extends the Catch Area of Any Lift Drain
- Fits the Ford E 40D
- Dimensions: 24" x 36"

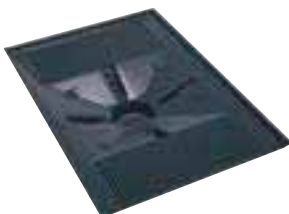

### Transmission Drain Pan



SKU 908383  
87035 **29<sup>99</sup>**

- Flexible Plastic Construction Fits on Top of Funnels for Most Lift Drains
- Built-In Screen to Catch Debris, Parts and Tools
- Dimensions: 22-3/4" (L) x 23-3/4" (W) x 4-3/4" (H)



## Filter Crusher



### Industrial 10 Ton Oil Filter/Can Crusher

SKU OUTSIDE BUY/EPO  
RANRP20FC **2,199<sup>99</sup>**

- Reduces Used Oil Filters to 1/4 of the Original Size
- 20,000 Lb. Crushing Power
- 100% Air Operated for Minimal Maintenance
- Save on Disposal Costs and Storage Space
- Automatic Safety Door Stops Operation When Opened
- Pressure Regulator and Air Moisture Separator Come Standard
- Transparent Door for a Convenient View of the Crushing Process
- Welded Steel Plate Construction
- Exclusive X-Shape Bevel in Press Head Pre-Aligns Filters for Absolute Vertical Press

**INCLUDES STAND**



For Outside Buy/EPO, Call 901-300-4878

## Used Oil Evacuation



- Includes All Necessary Fitting, Brackets, Valves, Hoses and Components for Seamless Integration with Air System and Fluid Collection/Discharge Processes

### Evacuation Package for Used Antifreeze

SKU 1485050  
BAL1121-025 **1,729<sup>99</sup>**

### 1" Evacuation Package for Used Oil

SKU 1485032  
BAL1121-024 **1,749<sup>99</sup>**



Prices subject to change without notice. Prices do not include applicable taxes, vehicles, tires, rims, installation or optional equipment as shown. Please do not return purchases to the store. For information regarding warranty, repair, or any questions or concerns, call 901-300-4878.

# OIL CHANGE

## Oil Filter Tools

**Swivel Oil Filter Wrench**  
SKU 1125870 **11<sup>99</sup>**  
87115

- Fits Oil Filters 4-3/4" to 5-3/4"
- 1" Wide Stainless Steel Band



### Auto Fit Filter Pliers

SKU 1339727 **14<sup>99</sup>**  
87164

- Suitable for Filters with 2.4" to 5" Diameters
- Long Reach Slip Joint Design
- Precision Machined Jaw
- Non-Slip Comfort Grip



### 3 Jaw Adjustable Magnetic Oil Filter Wrench

SKU 908387 **19<sup>99</sup>**  
25101

- Oil Filter Diameter: 2.4" to 3.6" (60 mm to 93 mm)
- Secure Magnetic Attachment
- Spring-Loaded Legs for a Secure Grip
- Includes 3/8" to 1/2" Drive Adapter



### 3 Jaw Adjustable Filter Wrench

SKU 1339734 **16<sup>99</sup>**  
87160

- Works on a Variety of Vehicles
- Fits Oil Filters 2-1/2" to 4-1/2" (63.5 mm to 114 mm)
- Fits 3/8" Drive Ratchets and Extensions
- Perfect for Removing Hard to Reach Filters



### 4 Piece Swivel Oil Filter Wrench Set

SKU 1414418 **34<sup>99</sup>**  
87117

- Fits Oil Filters 2-3/8" to 2-7/8", 2-7/8" to 3-3/8", 3-3/8" to 3-3/4" and 3-3/4" to 4-3/8"
- Dimpled Band with 3 Sets of Grippers to Hold Filter Securely in Place
- 1" Wide Stainless Steel Band for a Strong Grip and Slip Resistance
- Rubber Cushioned TPR Grip for Comfort and Safety in Tight Places
- Includes OEMTOOLS 87111, 87112, 87113 and 87114



### 4-in-1 Steel Oil Filter Wrench

SKU 1189097 **14<sup>99</sup>**  
87116

#### 4 Interchangeable Swivel Bands

- Size Range 2-3/8" to 4-3/8" (60.3 mm to 111.1 mm)
- 1 Swivel Handle with 4 Stainless Steel Bands
- Bands are Easily Removed and Installed



2 Detent Pins Help Quickly Remove and Install Bands



180° Swivel Joint Reaches Impossible Places

### 2-3/8" to 5" Oil Filter Pliers

SKU 757057 **18<sup>99</sup>**  
25324

- Removes Stubborn Oil Filters from Gas or Diesel Engines
- Long Reach Slip Joint Design
- Precision-Machined Jaw
- Non-Slip Comfort Grip
- 14" Length

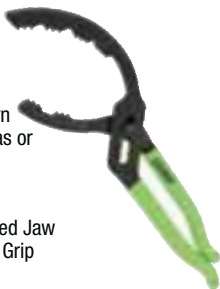

### 2-1/2" to 4-5/8" Oil Filter Pliers

SKU 548380 **13<sup>99</sup>**  
25320

- 20° Jaw Bend for More Applications
- Jaw Teeth for Sure Grip
- 12" Length



### Dual Drive Oil Filter Strap Wrench

SKU OUTSIDE BUY/EPO **24<sup>99</sup>**  
87119

- For Use with 3/8" or 1/2" Drive Tools
- Fits Oil Filters Over 8" in Diameter
- Heavy Duty 27" Nylon Strap



For Outside Buy/EPO, Call 901-300-4878

### 15" Chain Wrench

SKU 452624 **39<sup>99</sup>**  
22659

- Great for Stubborn Oil Filters
- Designed for Tight Spaces
- Double-Action Allows Use in Either Direction
- Capacity: 5-1/2" Diameter
- 15" I-beam Handle



### Heavy Duty Truck Oil Filters

- Extra Wide Band for Secure Grip
- 1/2" Drive Tools



SKU	Part #	Range	Price
344322	25231	4-1/8" to 4-5/8" (104 to 118 mm)	<b>19.99</b>
344323	25232	4-5/8" to 5-1/4" (118 to 134 mm)	<b>19.99</b>
344324	25233	5-1/4" to 5-3/4" (134 to 142 mm)	<b>21.99</b>

### Oil Filter Plug for Cummins

SKU 1340221 **12<sup>99</sup>**  
87168

- Perfect Tool for Installing and Removing Oil Filters
- Compatible with Dodge 6.7 Diesel Engines
- Prevents Oil Leaks When Removing Oil Filters from Engines
- Hard Plastic Construction for Maximum Strength and Durability
- Wide U-Shaped Handle for Added Grip and Control



### Filter Removal Cup

- Specifications: 6" x 6" x 6" (34 Oz. or 1 Liter), Volume Sufficient to Hold Typical Size Filters Commonly Used on Cars, SUVs, Light Duty Trucks and Vans
- Safely Holds Oils, Fuel (Gasoline, Diesel, Biofuels), Brake Fluid, Antifreeze and Other Hazardous Fluids



**1 Pack**  
SKU 1089033 **29<sup>99</sup>**  
SURFC5

**2 Pack**  
SKU 1245617 **39<sup>99</sup>**  
SURFC5PK2



**39<sup>99</sup>**  
REG. \$59.98

**SAVE \$19 OVER**

When You Buy the 2 Pack

### Swivel-Gripper "No-Slip" Filter Wrench - 9 Pack

SKU 1339725 **189<sup>99</sup>**  
LIS57160

- Includes:
  - (2) 2.375" - 2.625" Import Wrenches
  - (2) 2.875" - 3.250" Small Wrenches
  - (3) 3.500" - 3.875" Standard Wrenches
  - (2) 4.125" - 4.500" Large Wrenches





## Cap Style Filter Wrenches

### Toyota/Lexus Oil Filter Cap Wrench Set

SKU 383457 **22<sup>99</sup>**  
25409

- Sizes: 64 mm, 73 mm and 74 mm
- Comes in Sturdy Blow Mold Case

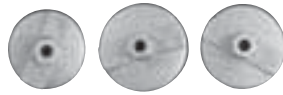

### 9 Piece Oil Filter Cap Wrench Set

SKU 255627 **99<sup>99</sup>**  
27199

- Includes: 5 Chrome Plated Aluminum Wrenches (64.5 mm - 14 Flute Toyota, 64.5 mm - 14 Flute Toyota/Lexus, 88.8 mm - 15 Flute Hyundai/Kia, 74.2 mm - 14 Flute European, 86.6 mm - 6 Flute European), (1) 63 mm to 83 mm Adjustable Filter Wrench for Universal Applications, 3 Forged Low Profile Oil Filter Sockets (27 mm, 32 mm and 36 mm) and 3/8" Drive Application Chart for Quick Reference



### 10 Piece Metric Cap Wrench Set

SKU 1189096 **34<sup>99</sup>**  
87151

- Painted for Rust Resistance
- Includes: 65/67 mm - 14 Flutes, 80 mm - 15 Flutes, 68 mm - 14 Flutes, 86 mm - 16 Flutes, 74/76 mm - 15 Flutes, 93 mm - 15 Flutes, 76 mm - 14 Flutes, 93 mm - 36 Flutes, 76 mm - 30 Flutes, 100 mm - 15 Flutes
- Comes in Sturdy, Green Blow Mold Case



OEM TOOLS®

Make	SKU	Part #	Size	Price	
BMW/Volvo	255675	25453	86.6 mm - 16 Flutes	<b>19.99</b>	
Hyundai/Kia	255659	25454	88.8 mm - 15 Flutes	<b>25.99</b>	
Toyota/Lexus	255634	25451	64.5 mm - 14 Flutes	<b>10.99</b>	
Toyota/Lexus	1340227	87131	64.5 mm - 14 Flutes	<b>9.99</b>	
Mercedes-Benz Sprinter/VW/Audi Porsche/Mazda	1340230	87132	74.2 mm - 14 Flutes	<b>4.99</b>	
Mazda/Ford	1340228	87133	75.6 mm - 14 Flutes	<b>4.99</b>	
Chrysler	1340234	87134	84 mm - 14 Flutes	<b>23.99</b>	
Volvo	1340237	87136	88.8 mm - 15 Flutes	<b>21.99</b>	
Land Rover	1340238	87137	90 mm - 15 Flutes	<b>22.99</b>	

## Drain Plug Tools

OEM TOOLS®

### 14 Piece Drain Plug Socket Set

SKU 818568 **29<sup>99</sup>**  
25374

- Designed for Both Foreign and Domestic Vehicles Including: BMW, Ford, Mazda, Mercedes-Benz, Nissan, Peugeot, Renault and More
- Ideal for Removal of Oil Drain Plugs from Manual Transmissions, Transfer Cases, Differential Housings and More
- Includes Hex: 9, 10, 12, 14 and 17 mm; Square: 7, 8, 11, 13 mm, 5/16", 3/8"; Female Square: 10 mm; Male Triangle: 10 mm; Tamper-Proof Triple Square: 16 mm

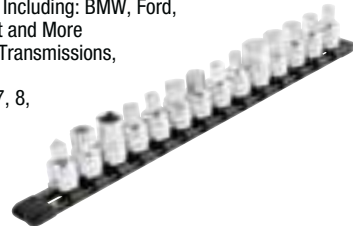

### 8-in-1 Oil and Lube Multi-Wrench

- Designed to Fit Most Oil Drains, Transfer Case and Differential Plugs
- Features Offset Head Design with Yoke Support for High Torque Applications



SKU 1442594  
CTA2495K

**49<sup>99</sup>**

- 6 Point Metric
- Sizes: 12, 13, 14, 15, 16, 17, 18 and 19 mm



SKU 1442585  
CTA2497K

**47<sup>99</sup>**

- Male Square and Hex
- Square: 8 mm, 10 mm, 3/8" and 1/2"
- Hex: 10, 12, 14 and 17 mm



### 3 Piece Plastic Oil Drain Plug Removal Set

SKU 1207894 **19<sup>99</sup>**  
25098

- Safely and Easily Removes Plastic Oil Drain Plugs on Late Model Ford, Volkswagen, BMW and Audi Cars
- 3/8" Drive
- Does Not Cause Damage to the Plug

OEM TOOLS®



## Oil Filter Sockets

### 7 Piece Oil Filter Removal Socket Set

SKU 191682 **37<sup>99</sup>**  
27197

- 3/8" Drive
- Includes: 24 mm for Cadillac; 27 and 36 mm for Mercedes-Benz, VW, Cadillac, Buick, Saturn, SAAB; 29 mm for Dodge Cummins Fuel Filter; 30 mm for Korean Cars; 32 mm for GM, Saturn and SAAB; 35/36 mm for Ford Diesel, Mini Cooper, BMW and Mack; 38 mm for Vauxhall Vectra
- Comes in Sturdy, Green Blow Mold Case

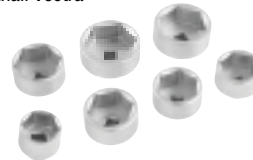

### 7 Piece Offset Oil Filter Cap Wrench Set

SKU 1145990 **25<sup>99</sup>**  
87165

- 3/8" Drive Set Includes: 24 mm for Cadillac; 27 and 36 mm for Mercedes-Benz, VW, Cadillac, Buick, Saturn, Saab; 29 mm for Dodge Cummins Fuel Filter; 30 mm for Korean Cars; 32 mm for GM, Saturn and SAAB; 35/36 mm for Ford Diesel, Mini Cooper, BMW and Mack; 38 mm for Vauxhall Vectra
- Comes in Sturdy, Green Blow Mold Case



OEM TOOLS®

### 32 mm Oil Filter Cap Socket

SKU 548385 **10<sup>99</sup>**  
25410

- Removes and Installs Oil Filters on 2.2 Liter GM Ecotec Engines Low Profile 1-1/4 In. Socket is Specially Designed for Operating Clearance 3/8" Drive



### 36 mm Oil Filter Socket for 6.0L Ford Diesel

SKU 110279 **11<sup>99</sup>**  
25411

### 3 Piece Low Profile Oil Filter Socket Set

SKU 094803 **21<sup>99</sup>**  
27204

- Includes: 27, 32 and 36 mm
- 3/8" Drive



# OIL CHANGE

## Oil Funnels

### Magnetic Funnel Holder

SKU 1372897 **9<sup>79</sup>**  
98375

- Translucent 16.9 Oz. Reservoir Holds a Variety of Funnels
- Dual Magnetic Arms Attach the Holder Securely to Any Ferrous Surface
- Magnets Securely Hold Up to 28 Oz. in Weight
- Swivel Design Allows for Easy Screw-In of the Receptacle Bottle
- Fits Standard One Quart Oil Bottle
- End Cap Keeps Drips off the Floor

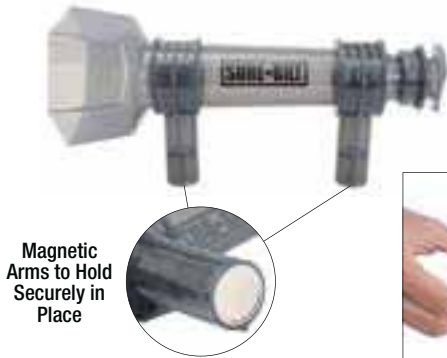

Magnetic Arms to Hold Securely in Place



End Cap Keeps Drips off the Floor



Holds a Variety of Funnels

STORE STOCKED

### Oil and Transmission Funnel

SKU 547009 **24<sup>99</sup>**  
87008

- Both Straight and 45° Angle Screen to Prevent Trash from Entering Transmission
- Includes Screen and Dust Cap
- Length: 25"



### Offset Funnel with Spout Cap and Lid

SKU LIS18232 **21<sup>99</sup>**

- 10" Tall Translucent Funnel with a 6-3/4" Offset from Center of Mouth to Center of Spout
- Lid and Spout Cap Help Keep Funnel Contaminant Free
- Includes: Offset Funnel with Cap and Lid, Adapter for Transmission and Other Dipstick Tubes



For Outside Buy/EPO, Call 901-300-4878

## Dispensers

### 8 Quart Dispenser Lid and Cap

SKU 080078 **34<sup>99</sup>**  
LIS19702

- Spout Cap and Lid to Keep Out Contaminants
- Many Large SUVs and Trucks Now Require More Oil



### 10 Quart Oil Jug

SKU 605325 **39<sup>99</sup>**  
87018

- Safe for Automotive Oils and Fluids
- Convenient Carry and Pour Handles
- Spill Proof Caps



### Flexible Spout Measuring Cans

- Designed for One-Hand Operation
- 14" Flexible Spout with Tapered Tip
- Recessed Bottom Drains Fully and Guards Against Punctures
- Rolled-Edge Top Helps Prevent Spilling

### 5 Quart

SKU 298486 **59<sup>99</sup>**  
LING525

### 8 Quart

SKU 298473 **69<sup>99</sup>**  
LING528



## No Spill Oil Funnels

### Universal Direct Fit No Spill Oil Funnel Set

SKU 824884 **79<sup>99</sup>**  
87039

- Set Includes: Universal Oil Funnel, Chrysler (87019), Ford/Mazda (87020), GM (87021), Honda (87022), Toyota/Lexus (87024), Subaru Adapter, Toyota/Lexus Adapter and 150° Extended Adapter (87027) and Storage Rack
- Funnel Screws Directly into Filler Neck
- Threaded to Fit a Range of Import and Domestic Vehicles Older and Current Models
- Transparent Lower Chamber to Monitor Oil Flow
- Wide Passage for Rapid Refilling



Includes Wall Mount Bracket and Drip Tray



## Drain Pans



### 16 Quart Oil Drain Pan

- Heavy Duty Polyethylene Construction
- Features a Pour Spout and No-Splash Lip



**Green**  
SKU 908389  
87034

**32<sup>99</sup>**

**Black**  
SKU 908382  
87033

**32<sup>99</sup>**

### 2.8 Quart Low-Profile Oil Drain Pan

SKU 568474 **10<sup>99</sup>**  
87017



Great for Motorcycles and Small Engines

### 4.7 Quart Clear Oil Drain Pan

SKU 568469 **13<sup>99</sup>**  
87013

- Built-In Level Scale Lets You See Fluid Level



Great for Transmission Fluid Changes

### 4.5 Gallon Black Oval Drain Pan

SKU 1142687 **49<sup>99</sup>**  
LIS17972

### 4.5 Gallon Green Oval Drain Pan

SKU 1142342 **49<sup>99</sup>**  
LIS17982



## Direct Fit Individual Funnels

SKU	Part #	Description	Price
824892	87019	Chrysler, Dodge and Jeep	<b>23.99</b>
824879	87021	GM	<b>18.99</b>
824890	87022	Honda	<b>21.99</b>
824888	87023	Subaru	<b>26.99</b>
824886	87024	Toyota, Lexus, VW and Mercedes	<b>26.99</b>



# COOLING SYSTEM

TO ORDER, contact your Commercial Sales Manager or go to [AutoZonePro.com](http://AutoZonePro.com)

COOLING SYSTEM

## Pressure Testers

OEM TOOLS

### Universal Cooling System Pressure Test Kit

SKU OUTSIDE BUY/EPO 27068 **99<sup>99</sup>**

- Quickly and Easily Pressure Test Cooling Systems in Most Vehicles
- Includes 3 Expandable Adapters that Take the Place of Numerous Specialized Adapters
- Easy Lever Style Pressure Relief Valve
- Prevents Damage to Plastic Reservoir Threads that Occurs When the Wrong Adapter is Forced on



For Outside Buy/EPO, Call 901-300-4878

### Universal Cooling System Adapter Set

SKU 434723 27067 **69<sup>99</sup>** REG. \$79.99

SAVE \$10

- Designed to Fit Most Passenger Vehicles and Light Duty Trucks
- Fits Both Radiators and Plastic Reservoirs
- Universal Design Works with Any Cooling System Pressure Pump
- Prevents Damage to Plastic Reservoir Threads That Occurs When the Wrong Adapter is Forced On
- Pressure Test Pump Not Included



Offer Good Through June 30, 2025

### Cooling System Pressure Test Pump

SKU 434722 27069 **79<sup>99</sup>**

- Quickly and Easily Pressure Test Cooling Systems in Most Vehicles
- High Quality Pressure Pump Designed to Work with Most Cooling System Adapters
- Easy-to-Use Lever Style Pressure Relief Valve



OEM TOOLS

### Heavy Duty Cooling Test and Refill Kit

SKU 954220 MSC43014 **119<sup>99</sup>**

- Includes: Vacuum Gauge, Sealing Collar, Valve, Rubber Gaskets and Coolant/Draining Hoses
- Sealing Collar (with Rubber Cone) Offers a Wide Variety of Applications for Radiator Filler Necks
- Minimizes the Risk of Engine Overheating
- 2.3 Gallons per Minute Fill Rate



Mastercool World Class Quality

### Heavy Duty Cooling Kit

SKU 954231 MSC43306 **479<sup>99</sup>**

- Includes: Heavy Duty Vehicle Adapters, Pressure Test Regulator, Vacuum Refill Attachment with Tubing in a Plastic Case
- For Use with Freightliner, International, Kenworth, Peterbilt, Mack, Volvo, GMC and Sterling Cooling Systems
- Uses Shop Air to Pressure Check and Vacuum Refill
- 4 Quick-Disconnect Vacuum Attachments Provide Quick Refilling of the Cooling System and Eradicates Airlocks



Mastercool World Class Quality

### 27 Piece Master Radiator Pressure Test Kit

SKU 1053958 MSC43301-A **359<sup>99</sup>**

- Includes: 1 Blue Radiator Cap Test Connector R123/R125, 1 Black Radiator Cap Test Connector R123/R124, 1 Thermometer, 1 Universal Radiator Cap, 1 Vacuum Purge and Refill Tool, Coolant Hose and Additional Installation Accessories, 1 Hand Pump and 19 Adapters (Nos. 2 to 4, 6 to 21) to Fit Most Popular Domestic and Import Cars and Trucks



Mastercool World Class Quality

## Cooling System Adapters

### Volvo, Saab, Jeep, Maserati, Ferrari

SKU 133600 27241R **34<sup>99</sup>**

- Fits Maserati and Ferrari Models (2000 - Newer), Jeeps with Male Threads (1990 - 1994), Saab 900 (1978 - 1993), Saab 900 (Drop Top 1994), Saab 9000 (1987 - 1998), Volvos with Male Threaded Necks
- Diameter: 45 mm
- Thread Size: 3 mm



### Radiator Adapter GM

SKU 133621 27118R **29<sup>99</sup>**

- Fits Many GM, Chrysler, Ford, Jaguar and Freightliner Models



### Audi and VW

SKU 133625 27245R **32<sup>99</sup>**

- Fits Audi A4 (1996 - Newer), A6 (1998 - Newer), A8 (1997 - Newer), S4 (2004 - Newer), TT (2000 - Newer), Bentley (2006 - Newer), Lamborghini (2006 - Newer), Porsche Cayenne (2003 - Newer), Porsche Panamera (2010 - Newer), Volkswagen Passat (1998 - Newer), Beetle (1998 - Newer), Golf and Jetta (1999 - Newer)



### BMW 3, 5 and 6 Series Radiator Adapter

SKU 133825 27252R **40<sup>99</sup>**

- Fits BMWs (2007 - Newer), 5 and 6 Series (2005 - Newer) and 3 Series (2006 - Newer)
- Diameter: 52 mm
- Thread Size: 3 mm



OEM TOOLS

### Mazda 3, Volvo S40/V50 and Ford

SKU 133633 27249R **39<sup>99</sup>**

- Fits Land Rover LR-2 (2008 - Newer), Mazda 3 (2004 - Newer), Volvo S40 and V50 (2004 - Newer), XC60 (2010 - Newer), Ford Fusion and Escape (2012 - Newer)
- Diameter: 50 mm; Thread Size: 2.5 mm



### Toyota, Lexus and Scion Radiator Adapter

SKU 133632 27248R **37<sup>99</sup>**

- Fits Lexus LS (2007 - Newer), Toyota Celica (2000 - Newer), Spyder MR2 (2000 - Newer), RAV4 (2009 - Newer), Prius (2004 and Newer), Camry (2007 - Newer), Highlander (2006 - Newer) and Scion XB (2008 - Newer)
- Diameter: 34 mm; Thread Size: 3 mm



### Acura, Chevrolet, Chrysler, Geo, Honda, Isuzu, Lexus, Mazda, Mitsubishi, Suzuki and Toyota

SKU 133624 27244R **24<sup>99</sup>**

- Fits Early Models with 32 mm Opening and a 9 mm Depth



### BMW and Range Rover Radiator Adapter

SKU 133635 27251R **34<sup>99</sup>**

- Fits BMWs 1988-2006, Land Rover and Range Rover Models 1995-2005
- Diameter: 52 mm
- Threads: 4 mm



### Ford, Jaguar, Pontiac, Range Rover and Saab Radiator Adapter

SKU 133611 27243R **31<sup>99</sup>**

- Fits Jaguar X Type (2002 - Newer), Saab 900 (1994 - 1998), Saab 9-3 and 9-5 (1999 - Newer), Some Saturns and Other Vehicles
- Diameter: 52 mm; Thread Size: 3 mm



### VW

SKU 133609 27242R **34<sup>99</sup>**

- Volkswagens with Female Threaded Filler Necks (1990 to 1998)
- Diameter: 57 mm; Thread Size: 3 mm



### Ford, Jaguar and Mazda Radiator Adapter

SKU 133631 27247R **35<sup>99</sup>**

- Ford Contour 1998-2000, Jaguar XJ8 1998-Up, Jaguar XK8 1997-2006, Mazda Tribute 2001-Up
- Diameter: 52 mm; Thread Size: 3 mm



Prices subject to change without notice. Prices do not include applicable taxes, vehicles, tires, rims, installation or optional equipment as shown. Please do not return purchases to the store. For information regarding warranty, repair, or any questions or concerns, call 901-300-4878.

AZG0225

# COOLING SYSTEM

## Coolant Funnels

### Professional No-Spill Coolant Funnel Kit

SKU 943142 **39<sup>99</sup>**  
87043

- 5 Spring-Loaded Adapters for a Secure Fit
- Simply Select the Correct Adapter, Attach the Funnel and Fill
- Air-Release Tubes to Vent the System During Refilling Process
- Stopper Prevents Dripping When Removing the Funnel
- Includes: Extensions and Adapters for Hard-to-Reach Surge Tanks



OEM TOOLS

### No-Spill Coolant Filling Funnel Kit

SKU 802197 **19<sup>99</sup>**  
87007

- 4 Radiator Cap Adapters to Fit Most Passenger and Light Trucks
- Simply Select Correct Adapter, Thread Together, Attach the Funnel and Fill
- Rotary Switch to Effectively Prevent Drips and Spills, and Stop Overflow and Bubbles
- Includes: 5 Adapters, (2) 45° Elbows and (2) 5" Extension Rods for Difficult-to-Reach Areas



STORE STOCKED

### No-Spill Coolant Filling Funnel Kit with Coolant Tester

SKU 1340229 **25<sup>99</sup>**  
87045

- Includes 5 Direct Fit Cooling System Adapters to Fit Most Passenger Vehicles and Light Trucks
- Includes: 45° Angled and 5" Extension Adapters for Accessing Hard-to-Reach Spots and Tester for Glycol Based Coolants
- Fluid Stopper to Prevent Drips and Spills When Removing from the Filler Neck



## Leak Tester

### Gas Engine Combustion Leak Tester

SKU 1103608 **29<sup>99</sup>**  
37145

- Used to Test for Combustion Leaks That Result from Head Gasket, Cylinder Head and Engine Block Leaks
- Pulls Air from the Cooling System Up Through the Leak Tester; if Carbon Dioxide is Present, the Leak Tester Fluid Color Will Change to Yellow Signifying a Combustion Leak



OEM TOOLS

### Combustion Leak Detector Fluid (8 Oz.)

SKU 391381 **9<sup>99</sup>**  
25739



STORE STOCKED

## Radiator Filler

### 2.4 Gallon Plastic Radiator Filler

SKU 754738 **24<sup>99</sup>**  
87104

- Impervious to Oil, Gasoline and Antifreeze
- Stands Up to Extreme Weather



OEM TOOLS

## AirEvac Cooling System

### AirEvac Cooling System Refiller

SKU 568478 **89<sup>99</sup>**  
24444

- Quickly Refills Cooling System and Eliminates Trapped Air
- Helps Prevent Come-Backs and the Threat of Engine Damage
- Universal Adapter Forms an Airtight Seal with Most Radiator and Coolant Bottle Necks
- Performs Vacuum Leak Tests
- Covers Most Radiator and Reservoir Types
- No Custom Adapters Required
- Comes in Sturdy, Green Blow Mold Case



### AirEvac Cooling System Kit

SKU 099292 **89<sup>99</sup>**  
27066

- Uses Shop Air to Evacuate the Cooling System for Vacuum Leak Testing
- Refills Cooling System without Trapping Air That Causes Overheating
- Universal Adapter Forms an Airtight Seal with Both Radiators and Coolant Reservoirs
- Self-Locking Quick Disconnects for Fast Assembly



OEM TOOLS

## Coolant Testing

### Professional Series Ethylene Glycol Antifreeze Tester

SKU 750007 **13<sup>99</sup>**  
24507

- For Testing Hot or Cold Ethylene Glycol-Based Coolants, Including Dex-Cool®
- Easy-to-Read Discs are Magnified by Convex Design of the Clear, Thermal Resistant Plastic Barrel
- Disc-Type 16-1/4" Tester is Accurate at All Temperatures (Celsius and Fahrenheit Scales)



(Color May Vary)

OEM TOOLS

## Flush Tools

### Coolant System Flush Gun

SKU 1284967 **39<sup>99</sup>**  
24719 REG. \$49.99

- Universal Nozzle to Fit Various Radiator or Heater Hoses
- Combines Water with Compressed Air to Quickly and Efficiently Flush Cooling Systems
- Comfortable Lever-Action Air Throttle with Lock-On Latch for Simple Attachment of Air Hoses
- Used for the Detailed Flushing of Debris and Contaminants from the Cooling System During Repair and Maintenance

Offer Good Through June 30, 2025



OEM TOOLS

SAVE \$10

### Heater Core Backflush Tool

SKU 511000 **36<sup>99</sup>**  
THX356

- Fits 1/2", 5/8" and 3/4" Heater Hoses
- Saves Costly Replacement of Most Stubbornly Clogged Heater Cores



- Made of Corrosion-Resistant Aluminum
- Basic Garden Hose Hook-Up Cleans Cooling Systems and Heater Cores without Disassembly

THEXTON

### Cooling System Back Flush Tool

SKU 750008 **29<sup>99</sup>**  
24506

- Non-Corrosive Aluminum
- Easy to Use

- Connects to Standard Hose 1/2", 5/8" and 3/4" Hose Fittings
- Made of Non-Corrosive Aluminum



OEM TOOLS

Prices subject to change without notice. Prices do not include applicable taxes, vehicles, tires, rims, installation or optional equipment as shown. Please do not return purchases to the store. For information regarding warranty, repair, or any questions or concerns, call 901-300-4878.

# COOLING SYSTEM

TO ORDER, contact your Commercial Sales Manager or go to [AutoZonePro.com](http://AutoZonePro.com)

COOLING SYSTEM

## Cooling System Tools

### 6 Piece Hose Clamp Pliers Set

SKU 1282734  
27158

- Services Most Ring-Type or Flat-Band Hose Clamps
- Clamps are Held Open with a Ratchet Locking Mechanism
- Includes: Regular Hose Clamp Pliers, Flat-Band Hose Clamp Pliers, Large Hose Clamp Pliers, Hose Remover Pliers, Angled Hose Clamp Pliers and Cable Hose Clamp Pliers



**76<sup>99</sup>**  
REG. \$103.99

**SAVE \$27**

When You Buy the Kit

### 4 Piece 14" Jumbo Pick Set

SKU 94658  
25940

**29<sup>99</sup>**  
REG. \$34.99

- Includes: Straight Pick, 90° Pick, Offset Pick and Hook Pick

**SAVE \$5**

OEM TOOLS



Offer Good Through June 30, 2025

### Clic-R Hose Clamp Pliers

SKU 1089038  
25102 **16<sup>99</sup>**

- Easily Remove or Install Clic-R Type High Tension Clamps
- Heavy Duty and Durable Steel Construction
- Clamps Commonly Found on BMW, Mercedes-Benz, Audi, VW and Other Cars and SUVs



### 5 Piece Hose Remover Set

SKU 1335785  
26519 **19<sup>99</sup>**

- Dual Durometer Handles for Comfort and Grip
- Hooks and Picks are Assembled from Carbon Steel for Strength and Durability
- Perfect for the Removal of Coolant Hoses, Cotter Pins Brake Springs, Large Electrical Connectors and More

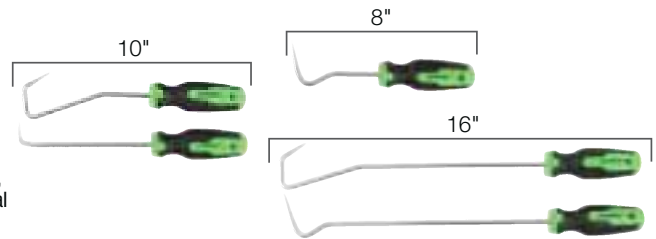

### GM Water Pump Socket

SKU OUTSIDE BUY/EPO  
27109 **29<sup>99</sup>**

- Works on 1993-newer Cadillac Northstar 4.6L V8 Engine (1993-newer) and Oldsmobile Aurora 4.0L L47 V8 (1995-1999) 1/2" Drive
- Black Oxide Finish to Resist Rust
- Chrome Vanadium Steel for Toughness



### Master Freeze Plug Installer Kit

SKU 965837  
27208 **69<sup>99</sup>**

- Designed to Remove and Install Freeze Plugs Used in Liquid-Cooled Gas and Diesel Engines

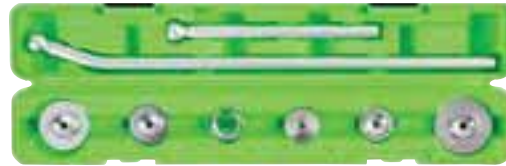

## Coolant Exchangers

MAHLE

### VCX-1 Vacuum Coolant Exchanger

SKU OUTSIDE BUY/EPO  
MSS4708001900  
**2,799<sup>99</sup>**

- Extremely Fast Service Cycles
- Simple Hook-Up and Operation
- Flexible Adaptation for Most Makes and Models



Coolant Not Included

### FluidPRO® MCX-2 Multi-Coolant System Fluid Exchanger

SKU OUTSIDE BUY/EPO  
MSS4708003000 **2,879<sup>99</sup>**

- Includes System Pressure Test Feature and "Hot Car" Radiator Cap Pressure Release
- Compatible with All Coolant Types for Adaptability
- Contains (2) 7.5 Gallon New Coolant Tanks and (1) 15 Gallon Waste Tank Providing Simple, Rapid Switching from One Coolant to Another
- 3 Minute Service Time for Increased Productivity



Coolant Not Included

### Vacufill Air Operated Coolant Exchanger with Drain Pump

SKU OUTSIDE BUY/EPO  
UVU570000X  
**1,699<sup>99</sup>**

- Includes: Auxiliary Pump for Emptying Waste Reservoir
- Large 12 Gallon Waste Coolant Reservoir
- Connects Easily to Engine Cooling Systems
- Large 3 Gallon New Coolant Tank
- Eliminates Potential Airlock Problems
- Tests for Leaks While Under Vacuum



Waste Pump



Coolant Not Included

VIEW

To Confirm Price, Availability and Ordering Instructions on Outside Buy/EPO, Call 901-300-4878

Prices subject to change without notice. Prices do not include applicable taxes, vehicles, tires, rims, installation or optional equipment as shown. Please do not return purchases to the store. For information regarding warranty, repair, or any questions or concerns, call 901-300-4878.

AZG0225

45

# SPECIALTY TOOLS

## Line Repair Tools



### 3/16" Brake Line Kit

SKU 662854  
SURBR-EZ316 **169<sup>99</sup>**

- 110 Piece Kit Includes Most Popular Brake Nuts, Unions and Adapters
- Made in USA
- UltraBEND Tubing Easy to Flare and Bend without Kinking
- Smooth Flares Create Better Fittings Seals, Reduces Potential for Leaks
- Includes: 110 Pieces Plus 25' of UltraBEND 3/16" Tubing
- Standard (SAE) and Metric Fittings Included



### Deluxe Fuel Line Replacement Kit

SKU 662866  
SURKP1500 **569<sup>99</sup>**

- Repair or Replace 1/4", 5/16" or 3/8" Fuel Lines in as Little as 5 Minutes
- No Special Insertion Tools Required
- Thumb Release Convenience Includes 168 Pieces Plus 75' of Tubing
- No Specialty Tools Required
- Pressure Rated Up to 200 psi



### Universal Flaring Set

SKU 954227  
MSC72475-PRC **569<sup>99</sup>**



- Create Perfect Production Quality Flares
- Magnetic Adapter Holder Keeps Adapters in Place
- Tube and Die Set Stabilizing Arm for Easy Tube Forming
- Enlarged Die Set Compression Area for Better Grip of Dies

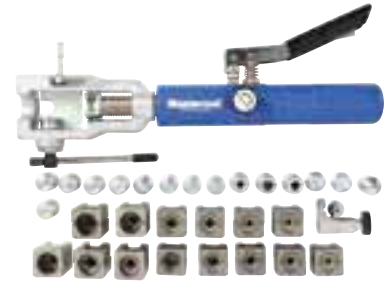

### Fuel Line Repair Assortment Kit



SKU 1392319  
DYNDY-FLA-2 **139<sup>99</sup>**

- Kit Includes 23 of the Top Selling Connectors, Fittings and Clamps
- 86 Total Pieces



### Pro Series Repair Assortment

SKU 1125882  
AIR78019 **499<sup>99</sup>**



- Everything You Need for Transmission and Power Steering Line Repair in One Convenient Kit - 16 Repairs
- 5 Minute Line Repair
- Leak-Free to 2,600 psi
- OE Approved



### Bubble Flaring Tool Kit



SKU 592261  
27214 **34<sup>99</sup>**

- Designed for Metric Soft Steel Brake Lines Where an "ISO" or Bubble Style Flare is Required
- Forged Yoke is Made of Heat-Treated Steel
- Includes: Flaring Bar, All Adapters Needed for ISO Bubble Flaring and 4 Dies (4.75, 6, 8 and 10 mm)



## Disconnect Sets

### NAVISTAR® MAXXFORCE® Fuel Line Disconnect Tool Set - 4 Piece

SKU 004112  
25031 **34<sup>99</sup>**

- 4 Piece Disconnect Tool Set for NAVISTAR® MAXXFORCE® Series 11 and 13 Engines
- Sized to Depress Fuel Release Tabs for Efficient Fuel Line Removal
- 1 Straight and (1) 90° Tool for 11.8 mm Fuel Lines;
- 1 Straight and (1) 90° Tool for 16 mm Fuel Lines



### Fuel Line Disconnect Set

SKU OUTSIDE BUY/EPO  
26514 **14<sup>99</sup>**



- Disconnects Fuel Lines and Spring Lock Couplings on Ford and Chrysler
- Sizes: 5/16", 3/8", 1/2", 5/8", 3/4" and 7/8"
- High Quality ABS Plastic That Can Easily Stand Up to Daily Usage
- Includes Reusable Holding Tray
- Easily Disconnects Air Conditioning and Quick Connect Fuel Lines

For Outside Buy/EPO, Call 901-300-4878



### Line Disconnect Set

SKU OUTSIDE BUY/EPO  
68941 **19<sup>99</sup>**

- Disconnects Fuel Lines and Spring Lock Couplings on Ford and Chrysler
  - Sizes: 5/16", 3/8", 1/2", 5/8", 3/4" and 7/8"
  - High Quality ABS Plastic that can Easily Stand Up to Daily Usage
  - Works on Fuel Lines and Other Quick Disconnect Couplings on Domestic and Import Vehicles
  - Angled Handles for Easy Access to Tight Spots
  - Sizes Include: 1/4", 5/16", 3/8", 1/2", 5/8", 3/4" and 7/8"
- For Outside Buy/EPO, Call 901-300-4878



### Angled Disconnect Set

SKU 291416  
LIS39400 **29<sup>99</sup>**

- Disconnects Spring Lock Couplings on Ford and Chrysler A/C Lines
- Works on Fuel Lines and Other Quick Disconnect Couplings on Domestic and Import Vehicles
- 6 Sizes: 5/16", 3/8", 1/2", 5/8", 3/4" and 7/8"



### Master Disconnect Tool Set

SKU 291413  
LIS39900 **79<sup>99</sup>**

- Contains 8 Tools for A/C and Fuel Lines
- Comes in a Blow Mold Case

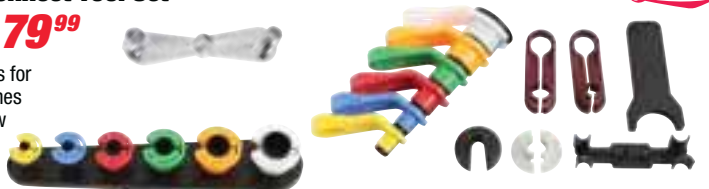

### Coolant Hose Removal Tool Set

SKU 383214  
CAL244TNZ **34<sup>99</sup>**

- Used to Completely Fill the Void in the Connector to Release the Fastener
- 40° Offset Designed for Jobs Up Against the Firewall or in Tight Spaces



# SPECIALTY TOOLS

TO ORDER, contact your Commercial Sales Manager or go to [AutoZonePro.com](http://AutoZonePro.com)

SPECIALTY TOOLS

## Spark Plug Service

### 3/8" Drive Magnetic Spark Plug 3 Piece Socket Set

SKU 300140 **19<sup>99</sup>**  
22891

- Includes: 5/8", 9/16" and 13/16"



#### Spark Plug Sockets

SKU	Part #	Drive	Size	Features	Price
082923	22880	3/8"	9/16"	Magnetic	<b>7.99</b>
082933	22887	3/8"	5/8"	Magnetic	<b>9.99</b>
082929	22881	3/8"	18 mm	Magnetic	<b>9.99</b>
082932	22883	3/8"	13/16"	Magnetic	<b>9.99</b>
082934	22889	1/2"	13/16"	Magnetic	<b>9.99</b>
082936	22895	3/8"	14 mm	12 Point Thin-Wall	<b>9.99</b>

### 3/8" Drive Magnetic Spark Plug Socket Extra Long (5/8")

SKU 300146 **14<sup>99</sup>**  
22885

- Hard Chrome™ Finish is Easy to Clean and Protects Against Rust
- Chamfered Ends Make Fastener Engagement Quick and Smooth
- Magnetic and Won't Wear Out or Be Damaged By Oil
- Deep Marking for Easy Identification Knurling Position for Best Finger Gripping



### 3/8" Drive Magnetic Spark Plug Socket Extra Long (9/16")

SKU 300147 **15<sup>99</sup>**  
22886



### 3/8" Drive 14 mm x 12 Pt. Extra Long Spark Plug Socket

SKU 814337 **17<sup>99</sup>**  
22813

- Designed with a Universal Joint for the Installation and Removal of Spark Plugs Situated in Tight Spaces
- Durable Chrome Moly Steel Construction
- 12" Extended Reach



12-POINT



Swivel Joint

### Adjustable Spark Plug Boot Pliers

SKU 1340226 **19<sup>99</sup>**  
25559

- Jaws Adjust to Five Different Positions for Easy Access to Spark Plug Boots
- Rubber Dipped Jaws Provide a Secure Grip for Damage Free Removal of the Spark Plug Boot
- Hardened Jaws Will Not Bend When Gripping
- Dipped Handle Grips for a Comfortable and Sure Grip

OEM TOOLS®



### Spark Plug Boot Pliers

SKU 390900 **13<sup>85</sup>**  
25542

- Designed to Remove Hard-to-Reach Spark Plug Boots
- 45° Offset Jaws for Easy Gripping of Wires and Boots



STORE STOCKED

### Spark Plug Wire Puller

SKU 532549 **4<sup>99</sup>**  
25061

- Insulates Hands from Electric Shock
- Grips Directly on Boot to Prevent Wire Damage



STORE STOCKED

## Specialty Sockets

### IPR Socket, 3/8" Drive

SKU 912334 **14<sup>99</sup>**  
25280

- Remove/Replace IPR without Damaging the Connector
- Applications: Ford 6.0 L and Other Diesel Engines



### Oxygen Sensor Socket Set

SKU 1103591 **21<sup>99</sup>**  
37110

- Special Purpose, Universal Slotted Socket That Services Hex Vacuum Switches and Oxygen Sensors
- Includes Sockets for Most Applications: 3/8" Drive 7/8" (22 mm) Deep, 3/8" Drive 7/8" (22 mm) Crowfoot, 1/2" Drive 7/8" (22 mm) Deep Crowfoot



OEM TOOLS®



### 7 Piece Sensor Socket Set

SKU 900823 **59<sup>99</sup>**  
27189

- Used for Oil Pressure Switches, Oil Pressure Sending Units and Thermal Sensor Switches
- Includes: 7/8" (22 mm) Offset Extended Oxygen Sensor, 7/8" (22 mm) Offset Oxygen Sensor Socket, 7/8" (22 mm) Vacuum Switch Socket, 7/8" (22 mm) Oxygen Sensor Socket, 1-1/16" (27 mm) Deep Oil Switch Socket, 1-3/16" (29 mm) Oil Sender Unit Socket and 1-1/16" (27 mm) GM Thermal Sensor Switch Socket
- Chrome Vanadium for Toughness



## Insulated Tools

### 10 Piece Insulated Screwdriver Set

SKU 1267942 **24<sup>99</sup>** REG. \$29.99  
22593

SAVE \$5

- 1,000V VDE Certified Insulated Screwdrivers
- Insulated Grip Handle and Precision Handle for Added Efficiency
- Insulation Sculpted Directly Onto Blade for Permanent Bonding
- Quick-Release Mechanism for Effortless Blade Change
- Exchangeable Blades with a Slim Tip to Fit Tight Terminal Blocks
- Durable Tool Pouch Included for Easy Organization
- Includes 4 Slotted Blades



OEM TOOLS®



Prices subject to change without notice. Prices do not include applicable taxes, vehicles, tires, rims, installation or optional equipment as shown. Please do not return purchases to the store. For information regarding warranty, repair, or any questions or concerns, call 901-300-4878.

AZG0225

47

# SPECIALTY TOOLS

## Fuel Pump Tools



### Fuel Tank Adapter

SKU 1407554  
24832 **129<sup>99</sup>**

- Makes Fuel Tank Removal Safe and Easy
- Works with Most Transmission Jacks
- Includes: 2 Nylon Straps to Secure Tank
- Foam Rubber Pads Protect Tank

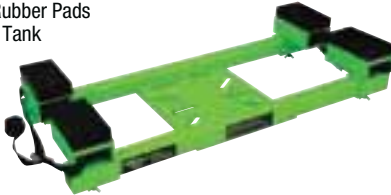

### Bed Lifter

SKU OUTSIDE BUY/EPO  
STK35885 **329<sup>99</sup>**



- Designed to Lift Truck Beds Safely and Easily
- Lifting Brackets Adjusts to Evenly Distribute Weight

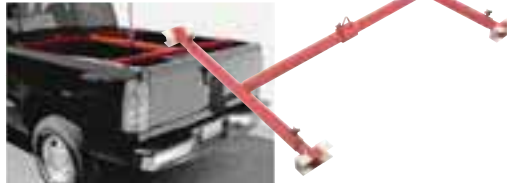

For Outside Buy/EPO, Call 901-300-4878

## Terminal Tools



### 19 Piece Master Terminal Tool Set

SKU 447159  
27169 **139<sup>99</sup>**

- Latest Tools for Coolant Sensors, Wiring Harnesses and Terminal Blocks on Most Modern Vehicles
- Eliminates Potential Damage to Wires or Terminal Blocks
- Application Chart Included Inside Storage Case

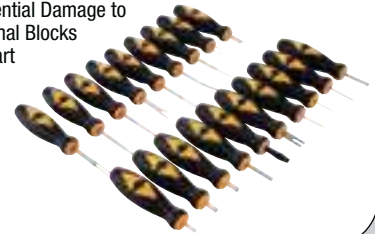

### Fuel Pump Module Spanner Wrench

SKU 110278  
25156 **29<sup>99</sup>**

- Removes and Installs the Fuel Pump Retaining Ring



### Fuel Tank Lock Ring Tool

SKU 751721  
24398 **34<sup>99</sup>**



- Ford F150 Trucks (2004 - Newer); Chrysler/Dodge Mini-Vans, PT Cruiser, Dakota, Durango (2004 - Newer); Chevy 1/2 Ton and 3/4 Ton Trucks (2004 - Newer)
- Works with 1/2" Drive Ratchet or Breaker Bar



### Adjustable Multi-Arm Lock Ring Tool

SKU 1491306  
25558 **29<sup>99</sup>**

- Interchangeable Arms to Remove and Install the Retaining Ring on the Fuel Pump Module
- Adjustable Arms to Easily Adjust to the Fitment of the Retaining and Locking Rings
- Slip Resistant Spanner to Limit Damage to the Lock Ring and Retaining Ring
- 3/8" Square Drive



## Relay Tester



### Relay Circuit Tester

SKU 383450  
27211 **119<sup>99</sup>**

- Cut Relay Related Diagnosis Time by 75%
- Identify at the Push of a Button if a Wire, a Part, or a Relay is Defective
- Test an Entire Circuit from the Battery to the Component
- Bypass Relays to Do Compression Test, Fuel Pressure Test, A/C Fill, etc.
- Kit Includes: Tester, 6 Popular Relay Leads and 1 Universal Relay Lead
- Comes in a Sturdy Blow Mold Case



## Throttle Depressors



### Brake - Accelerator Pedal Depressor

SKU 802194  
24232 **34<sup>99</sup>**

- Holds Brake or Accelerator Pedal at Desired Position
- Easy to Adjust
- Extends to 24"
- Suitable for Many Diagnostic Applications

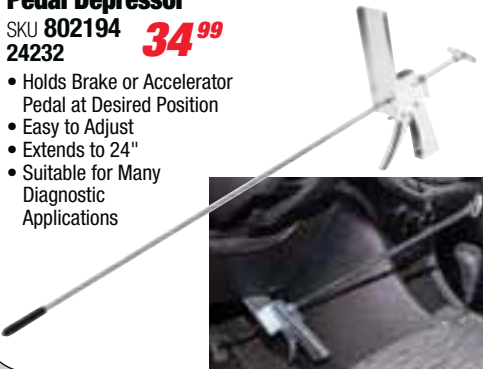

### Steering Wheel Holder and Pedal Depressor Set

SKU 802195  
24231 **64<sup>99</sup>**



- Holds Steering Wheel in Position for Alignment Adjustments
- Depresses Brake Pedal for Various Brake Checks Including Brake Lamp Operation
- Simply Hand Squeeze the Actuator to Accomplish Fine Adjustments



### Throttle Pedal Depressor

SKU 222525  
LIS48700 **54<sup>99</sup>**



- Holds Throttle at a Constant RPM
- Engage the Nylon Hook Under the Steering Wheel, Then Extend the Depressor Rod to the Accelerator Pedal
- Length: 40"

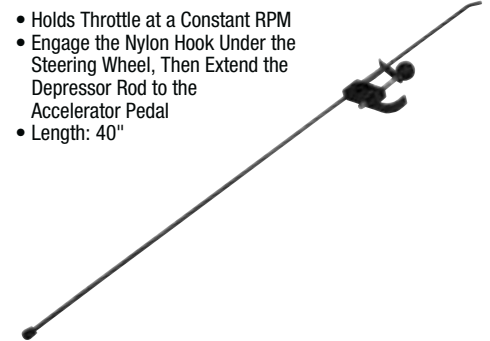

## Relay Tools

### Relay Puller Pliers

SKU 291342  
LIS46950 **34<sup>99</sup>**

- For Removing Electrical Relays on Most Domestic and Import Vehicles
- Allows Relay to Pop Free from Socket with Less Chance of Damaging the Relay



### Relay Test Jumper Set II

SKU 291341  
LIS60610 **114<sup>99</sup>**

- Includes 4 Jumpers to Fit Many Popular Relays on Honda, Nissan, Toyota, Newer Ford and GM Mini Micro Relays as well as International Trucks



### Relay Test Jumper Set

SKU 291333  
LIS56810 **114<sup>99</sup>**

- Includes 4 Jumpers to Fit the Most Popular Size Relays on Domestic and Import Vehicles
- Jumpers Have Tabs for Clamping and Flat Pads to Place Test Leads On





# SPECIALTY TOOLS

TO ORDER, contact your Commercial Sales Manager or go to [AutoZonePro.com](http://AutoZonePro.com)

SPECIALTY TOOLS

## Wire Strippers

### 8-1/4" Wire Stripper/Cutter/Crimper/Bolt Cutter

SKU 312821 **13<sup>99</sup>**  
25193

- AWG: 10, 12, 14, 16, 20 and 22 Stranded
- AWG: 8, 10, 12, 14, 16 and 18 Solid
- Crimps 7 and 8 mm Ignition Terminals



### 9-1/2" Terminal Crimping Pliers with Cutter

SKU OUTSIDE BUY/EPO **14<sup>99</sup>**  
25196

- For Insulated and Non-Insulated Wire Connectors and Terminals
- Specially Hardened Wire Cutter in Nose
- Tapered Nose for Working in Confined Spaces
- For 10 to 22 AWG Wire Connect
- Plastic-Dipped Comfort Handles Minimize Fatigue

OEM TOOLS<sup>®</sup>



For Outside Buy/EPO, Call 901-300-4878

### 7" Wire Stripper Crimper - Cutter

SKU 751657 **22<sup>99</sup>**  
24452

- Strips 20-12 Gauge Insulated and Non-Insulated Wire
- Use for Wire Cutting and Stripping, as Pliers for Grabbing and Twisting or for Crimping of Insulated and Non-Insulated Connectors
- Industrial Finish with Red Textured Grips



### 6-in-1 Long Nose Pliers

SKU 177785 **24<sup>99</sup>**  
22631

- Wire Strippers: 10, 12, 14, 16, 18, 20, 22 AWG
- Wire Crimper: 10 - 20 AWG
- Ergonomic Pistol Grip for Added Leverage
- Ideal for Hard-to-Reach Spot



## Circuit Testers

### Digital Display Circuit Tester

SKU 568468 **29<sup>99</sup>**  
24451

- Detect Voltage, Power, Ground and Circuit Condition
- Display Provides Precise Voltage
- Voltage: 5 to 30V DC
- Computer Safe - DO NOT Use on Airbags



OEM TOOLS<sup>®</sup>



Voltage Display

### Coiled Cord Circuit Tester

SKU 422468 **7<sup>99</sup>**  
25886

- Circuit Tester with a Stretchable and Retractable 12' Cord for Long Circuit Runs

OEM TOOLS<sup>®</sup>



### One Handed Wire Piercing Circuit Tester

SKU 422469 **18<sup>99</sup>**  
25887

- Bright Hi-Vis 12' Heat and Oil Resistant Coiled Cord
- Molded Strain Relief for Long Life
- Hangs on Wire for Hands-Free Operation
- 6, 12 and 24 Volt Systems



OEM TOOLS<sup>®</sup>

### Memory Saver/Parasitic Drain Monitor

SKU OUTSIDE BUY/EPO **199<sup>99</sup>**  
PWPPDRAW

- Connects Via 16Pin OBDII Port and Supplies Power and Monitors the Vehicles Electrical System for Parasitic Draw
- View and Record Data Via Bluetooth on Power Probe Link App
- Graphing Mode for Displaying Voltage and Amperage as a Wave Form
- Readings are Displayed on the LCD Screen
- Capable of Delivery Up to 10 Amps Continuous Current

POWER PROBE<sup>®</sup>



For Outside Buy/EPO, Call 901-300-4878

### ECT3000 Electrical Circuit Tracer

SKU 1392338 **149<sup>99</sup>**  
PWPECT3000B

- Automatic and Manual Sensitivity Locking
- Arrow Indicates Direction to Short
- Signal Distance Indicator Bar
- 10 Minute Auto Shut Off
- Ergonomic Housing

POWER PROBE<sup>®</sup>



## Windshield Tools

### Compact Windshield Wiper Arm Puller

SKU 191681 **12<sup>99</sup>**  
25319

- Easily Removes Wiper Arms on Most Domestic and Foreign Vehicles
- Will Not Damage Wiper Arm or Hood Cowling During Removal
- Features Turning Knob for Fast Work and Forged Body for Strength
- Compact Design Works Great in Tight Spaces



OEM TOOLS<sup>®</sup>

### Window Holder

SKU 191670 **14<sup>99</sup>**  
25309

- Works on All Cars and Trucks with a Top Door Frame
- Loop Cable Over Door Frame and Attach Suction Cups to Each Side of Glass
- Window Glass is Securely Held Above the Door While Work is Performed

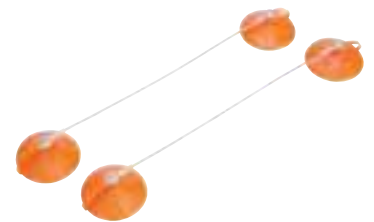

OEM TOOLS<sup>®</sup>

### Universal Wiper Arm Puller

SKU 265136 **29<sup>99</sup>**  
25339

- For Pulling Front and Rear Wiper Tight Fitting Wiper Arms
- Suitable for Most Wiper Arms Including Audi<sup>®</sup>, VW<sup>®</sup>, BMW<sup>®</sup>, Ford<sup>®</sup>, Chevrolet<sup>®</sup>, Mercedes-Benz<sup>®</sup> and Others
- Designed to Prevent Damage to Wiper Arm Nozzle

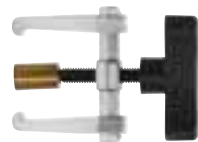

OEM TOOLS<sup>®</sup>

### Window Molding Clip Remover

SKU 265130 **5<sup>99</sup>**  
25338

- Use to Release Body Molding Clips
- Double-Sided Design Works on a Variety of Clip Configurations
- Made with Heat-Treated Carbon Steel for Strength



OEM TOOLS<sup>®</sup>

### Double Head Suction Cups

SKU 291351 **14<sup>99</sup>**  
24246

- Twin Head Suction Cups Help Remove Windshields
- ABS Rubber Cups Grab Hold of Glass
- Flexible Handle Bends to Windshield
- Quick Release Levers for One-Hand Operation



OEM TOOLS<sup>®</sup>

### 18" Professional Windshield Knife

SKU 480782 **29<sup>99</sup>**  
CAL53100

- Constructed of Heavy Duty Steel and Aluminum with a Padded Ergonomic Handle

CALIFORNIA



Prices subject to change without notice. Prices do not include applicable taxes, vehicles, tires, rims, installation or optional equipment as shown. Please do not return purchases to the store. For information regarding warranty, repair, or any questions or concerns, call 901-300-4878.

# SPECIALTY TOOLS

## Torque Wrenches

### 3/8" Drive (10-80 Ft/Lb.)

SKU 177722 **59<sup>99</sup>**  
25694

### 1/2" Drive (25-250 Ft/Lb.)

SKU 177715 **99<sup>99</sup>**  
25695

### 1/2" Drive (10-150 Ft/Lb.)

SKU 012651 **69<sup>99</sup>**  
25689



OEM TOOLS®

### 3/8" Drive Torque Wrench (25-250 In/Lb.)

SKU 133657 **34<sup>99</sup>**  
25685

- 45 Tooth Round Head Ratchet
- Both Clockwise and Counterclockwise Operation



OEM TOOLS®

### Click Style Torque Wrench - 3/8" Drive

SKU 133658 **34<sup>99</sup>**  
25686

- Precision Torque Control by 45-Tooth Ratchet Head
- Audible Click When Desired Torque is Reached
- Both Clockwise and Counterclockwise Operation
- High Grade Spring Steel Torque Mechanism



OEM TOOLS®

### 3/4" Torque Wrench (50-400 Ft/Lb.)

SKU 1103610 **199<sup>99</sup>**  
37309

#### Ideal for Replacing Ford F150 Front Wheel Bearings

- Range: 50-400 Ft/Lb. and 84.7-559.2 N-m
- Increments 2.5 Ft/Lb.



OEM TOOLS®

### 1/4" Drive Torque Wrench (20-200 In/Lb.)

SKU 954210 **209<sup>99</sup>**  
CEN97361B

- Push Through Square Drive for Reverse Operation
- Reverse Window Laser Marking
- Rubber Over-Mold Lock Ring for Better Grip
- NIST Certified



Central TOOLS, Inc.  
QUALITY AND INNOVATION SINCE 1908

### 1/2" Drive Click Style Torque Wrench (25-250 Ft/Lb.)

SKU 133659 **56<sup>99</sup>**  
25687

- Both Clockwise and Counterclockwise Operation

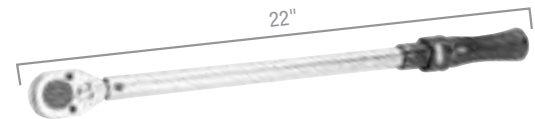

OEM TOOLS®

### 3/4" Drive Torque Multiplier

SKU 191056 **299<sup>99</sup>**  
25683

- Increased Torque Output Converts Low Torque (Max. 650 Ft/Lb.) to High Torque (2,200 Ft/Lb., 3000 Nm) with Planetary Gear Set for Heavy Duty Tightening and Loosening
- Input Drive: 3/4"
- Output Drive: 1"

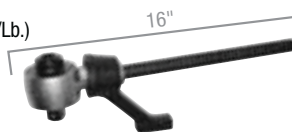

OEM TOOLS®

### 3/4" Drive Professional Micrometer Torque Wrench (100-600 Ft/Lb.)

SKU 217376 **299<sup>99</sup>**  
25688

- Right Hand Direction

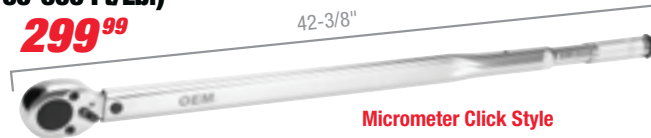

OEM TOOLS®

Micrometer Click Style

## Measuring Tools

### Tire Tread Depth Gauge

SKU 954233 **39<sup>99</sup>**  
CEN3S402A

- Easy-to-Read Digital Display
- Fractional Scale in 1/32" Increments
- Spring-Loaded Plunger



Central TOOLS, Inc.  
QUALITY AND INNOVATION SINCE 1908

### 24" Straight Edge

SKU 949552 **41<sup>99</sup>**  
25355

- Constructed with 1/4" Thick Cold Rolled Steel
- Durable Powder Coat Finish with Precision Ground Edge
- Hang Hole for Convenient Storage
- Includes Reusable Protective Edge



OEM TOOLS®



### 6" Electronic Digital Caliper

SKU 864649 **31<sup>99</sup>**  
25363

- Large Easy to Read LCD Display
- Zeroing Feature



OEM TOOLS®

- Thumb Roller with Locking Device

### 1" Dial Indicator Set

SKU 954195 **99<sup>99</sup>**  
CEN3D101

- Strong Magnetic Base
- Revolution Counter
- Full 1" Range



Central TOOLS, Inc.  
QUALITY AND INNOVATION SINCE 1908

### Indicator Set with Flex Arms and Lock Pliers

SKU 954184 **129<sup>99</sup>**  
CEN3D103

- Locking Pliers for Mounting
- Flex Arm for Extra Reach
- Revolution Counter
- Full 1" Range



Central TOOLS, Inc.  
QUALITY AND INNOVATION SINCE 1908

### Extended Range Bore Gauge

SKU 954188 **209<sup>99</sup>**  
CEN3D302

- Extended Range of 1.4" to 6"
- Lower Range for Small Applications
- Reach Deep into Cylinders



Central TOOLS, Inc.  
QUALITY AND INNOVATION SINCE 1908

### 0-5.5" Digital Rotor Gauge

SKU 954197 **99<sup>99</sup>**  
CEN3M430A

- Easy-to-Read Digital Display
- Pointed Anvil for Measuring Grooves
- Inch and Metric Readings



Central TOOLS, Inc.  
QUALITY AND INNOVATION SINCE 1908

### Digital Drum Gauge

SKU 954196 **254<sup>99</sup>**  
CEN3B531

- Depth Stops to Improve Accuracy
- Pointed Anvils for Grooves
- Easy-to-Read Digital Display
- 4" to 20" Range Plus Oversize



Central TOOLS, Inc.  
QUALITY AND INNOVATION SINCE 1908

### 3/8" Drive Digital Torque Adapter

SKU 362559 **49<sup>99</sup>**  
25684

- Range: 19 to 99 Ft/Lb. (27 to 135 Nm)
- Comes in a Sturdy Blow Mold Case



OEM TOOLS®

### 25' Tape Measure

SKU 1414409 **19<sup>99</sup>**  
25699

- Two-Sided Blade Printed in Centimeters and Inches
- 1" Extra Wide Blade
- 10" Standout Reach
- Magnetic End with Dual Hooks
- Heavy Duty Impact-Resistant Case



OEM TOOLS®

# SPECIALTY TOOLS

TO ORDER, contact your Commercial Sales Manager or go to [AutoZonePro.com](http://AutoZonePro.com)

SPECIALTY TOOLS

## Steck - Lockout Tools

### BigEasy™ Glo with Easy Wedge Lockout Kit

SKU 964494 **99<sup>99</sup>**  
STK32955

- Glow-In-The-Dark Yellow Allows You to See the Tool at Night or Through Tinted Windows
- Easy Wedge Offers Controlled Opening of the Car Door for Inserting the BigEasy Glo



Glow in the Dark

### BigEasy™ Carrying Case

SKU 227873 **39<sup>99</sup>**  
STK32935

- Made of Soft, Yet Firm Material to Protect Your BigEasy Kit
- Custom Pockets for the BigEasy, Non-Marring Wedge, Lock Knob Lifter and Easy Wedge
- Makes it Convenient to Stow Your BigEasy Kit in Your Truck



### BigEasy™ Lockout Kit

SKU 964491 **49<sup>99</sup>**  
STK32900

- High Visibility Pink Powder Coating and Improved Non-Marring Wedge
- Lock Knob Lifter for Cars with Flat Lock Knobs at the Top of the Door
- Paint Protector Reduces Friction Between the Car Door and the BigEasy

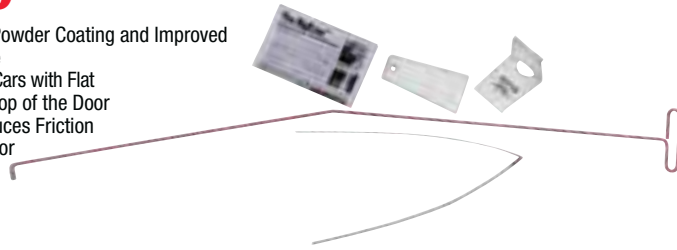

### BigEasy™ Easy Wedge (Inflatable)

SKU 964493 **49<sup>99</sup>**  
STK32922

- Inflatable Controlled Opening of Car Door for Insertion of the BigEasy



## Access Tools - Lockout Tools

### Emergency Response Kit Long Case

SKU 1339730 **199<sup>99</sup>**  
AETERKLC

- Most Popular Accessories, Gets into Any Vehicle
- Designed by First Responders
- Emergency Ready
- Includes: Quick Max Long Reach Tool, Flex Max, Button Master, Super One Hand Jack Tool, Super Air Wedge, Glassman Wedge and Button Strip Tool



### Button Master

SKU 1189051  
AETRCBM

**54<sup>99</sup>**

- Flexible Coated Long Reach Tool
- Retractable Loop with Grip Cover
- Grab Vertical Door Buttons with Ease
- Approximately 38" in Length When Straightened
- Most Flexible and Versatile Version of All the Button Masters



AccessTools

### One Hand Jack Set

SKU 1145698 **124<sup>99</sup>**  
AETOHJS4

- Easy-to-Use Car Opening Kit
- Soft Shielded Long Reach Tool That Won't Scratch Paint
- Air Wedge with Stiff Insert for Easy Insertion
- Vertical Button Tool One Hand Jack for Quick, Damage-Free Insertion of the Air Jack



## Rivet Tools

### 500 Piece Aluminum Rivet Assortment

SKU 271150 **13<sup>99</sup>**  
68109

- Includes: 1/8" and 3/16" Rivets 1/4", 5/16" and 3/8" Long



HARDWARE  
MACHINERY



### Industrial Hand Riveter

SKU 291353 **47<sup>99</sup>**  
25921

- For Use with Steel and Aluminum Rivets Noses: 1/8" (3.2 mm), 5/32" (4.0 mm), 3/16" (4.8 mm), 1/4" (6.4 mm)
- 18" Overall Size with Long Handle Provides More Leverage

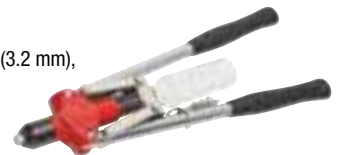

OEM TOOLS

### Nut Rivet Set Metric

SKU 94888 **129<sup>99</sup>**  
MAR39303

- Includes the 39200 Thread-Setter Tool with 8-32, 10-32 and 1/4-20 Mandrels and Nosepieces and Wrench
- Contains 44 Assorted Klik Poly-Nuts



marson

### Big Daddy® Hand Riveter

SKU 094886 **229<sup>99</sup>**  
MAR39031

#### Sets Large Diameter Blind Rivets.

- Double Gear Reduction System Easily Sets from 1/8" to 1/4" Diameter Klik-Fast Rivets in All Alloys Including 1/4" Klik-Split® Rivets
- Comes with 5/32", 3/16" and 1/4" Nose Pieces Stored in the Body



marson

See More Marson Rivet Tools on [AutoZonePro.com](http://AutoZonePro.com)

Prices subject to change without notice. Prices do not include applicable taxes, vehicles, tires, rims, installation or optional equipment as shown. Please do not return purchases to the store. For information regarding warranty, repair, or any questions or concerns, call 901-300-4878.

AZG0225

# SPECIALTY TOOLS

## Slide Hammer Pullers

### 5 Lb. Slide Hammer

SKU 1103572 **54<sup>99</sup>**  
37033

- For a Variety of Pulling Tasks
- Chrome Plated Main Shaft
- Thread: 5/8" x 18



### 9 Way Slide Hammer Puller Set

SKU 1335798 **119<sup>99</sup>**  
37191

- Pulls Flange-Type Rear Axles and Most Front Wheel Drive Hubs
- Internal and External Jaws Provide a Variety of Combinations to Pull Bearings, Gears and Seals
- 2-Way and 3-Way Cross Blocks
- Includes: Grip Wrench Adapter and Dent Puller Attachment
- Designed for Use with Other 5/8" x 18 Thread Slide Hammer Attachments

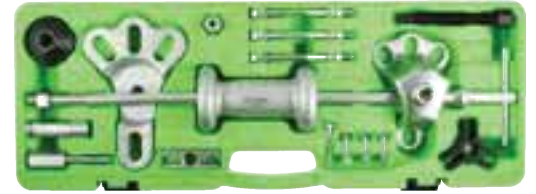

OEM TOOLS®

### Rear Axle Puller Set

SKU 094801 **69<sup>99</sup>**  
27202

- Use for Flange-Type Rear Axle and Bearing Removal on Most Late Model Passenger Cars and Light Trucks
- Slide Rod and Adapters are 5/8" x 18 Standard Threads

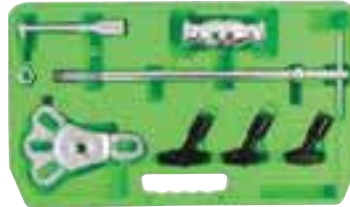

### VW/Audi Fuel Injector Puller Kit

SKU 1103636 **59<sup>99</sup>**  
37383

- Includes: 1 Mini Slide Hammer, 1 Installation Tool, 2 Special Puller Attachments and 3 Knurled Collars
- Comes in a Sturdy Blow Mold Case
- Used with All 2.0 L TSI/FSI/TSFI Engines



## Multi-Purpose Puller

### Multi-Purpose Bearing and Pulley Puller Set

SKU 900824 **119<sup>99</sup>**  
27190

- Use on Pitman Arms, Timing Gears, Carrier Side Bearings, Crankshaft Pulleys and More
- 20 Piece Set Includes: 6 Jaws, 2 Bar Housings 6 Bolts and 2 Retainers
- Capacity: 6-10 Tons (Depending on the Jaws)
- Combine to Create 10 Different Pullers



OEM TOOLS®

## Retainer Remover

### Brake Cylinder Retainer Remover

SKU 265111 **14<sup>99</sup>**  
25268

- Expands and Holds Special Retainer So the Brake Cylinder May Be Removed
- Releases the Spring Clip Retainer That Attaches the Rear Brake Cylinder to Backing Plate



OEM TOOLS®

## Lock and Snap Ring Pliers

### Professional Internal/External Snap Ring Pliers

SKU 1340233 **19<sup>99</sup>**  
25097

- Unique Jaw Design Makes it Easy to Switch from Internal to External Configurations
- For Both Internal and External Rings
- Alloy Steel and PVC Grip with Storage for Tips
- Includes: 3 Pairs of Tips and Hex Key, 1 Pair Straight Tips for 1.2 mm and 1.8 mm, 2 Pair 90° Tips for 1.2 mm and 1.8 mm



### Angle Tip Lock Ring Pliers

SKU 191055 **29<sup>99</sup>**  
25354

- For Spreading Snap Rings Found on Brakes, Pedal Shafts, Clutch Shafts, Transmissions, Machine Tools and Piston Rings
- Constructed with Durable Drop Forged Steel Alloy
- Spring-Loaded Jaws Feature a Scored Outside Edge for a Secure Grip
- Vinyl Grip Handles for Added Comfort and Control
- Spread: 3/4"
- Length: 8-1/4"



### 10 Piece Snap Ring Pliers Set

SKU 900819 **74<sup>99</sup>**  
27180

- Includes: (2) 5-1/2" Bent Pliers (0.038" and 0.047" Tip), (2) 6" Straight Pliers (0.038" and 0.047" Tip), 7-1/2" Bent Pliers (0.070" Tip), 8" Straight Pliers (0.070" Tip), 8-1/2" Bent Pliers (0.090" Tip), 9" Straight Pliers (0.090" Tip), 1 Pick Tool and 1 Hook Tool
- For Both Internal and External Rings
- Constructed with Heat-Treated Chrome Moly Steel
- Comes in Sturdy Blow Mold Case



OEM TOOLS®

## 2/3 Jaw Pullers

### 1 Ton Puller

- Standard Jaw Puller Made with Hi-Alloy Steel
- Jaws Grip Tighter as Pressure is Applied
- Adjustable and Reversible Jaws with 2 and 3 Jaw Configuration

**3" Spread**  
SKU 246386 **19<sup>99</sup>**  
25902

**4" Spread**  
SKU 246387 **24<sup>99</sup>**  
25903

**5 Ton**  
SKU 516519 **39<sup>99</sup>**  
27078



25902



25903



27078



OEM TOOLS®

Prices subject to change without notice. Prices do not include applicable taxes, vehicles, tires, rims, installation or optional equipment as shown. Please do not return purchases to the store. For information regarding warranty, repair, or any questions or concerns, call 901-300-4878.

## Cam/Crankshaft Tools

### Crank Bolt Sockets

Deep Counter-Weighted Sockets Provide Increased Torque to Break Loose Stubborn Crank Bolts

- Applications: Honda-Acura, Models: Accord, Civic, Pilot, CRV, Odyssey, CL TL Integra, MDX, Vehicles. Plus Toyota-Lexus, Models: Camry, Corolla, 4Runner, Sequoia, ES300, LS400 Vehicles and More

**17 mm**  
SKU 912348 **19<sup>99</sup>**  
25275

**19 mm**  
SKU 1335801 **19<sup>99</sup>**  
25290

**21 mm**  
SKU 912343 **19<sup>99</sup>**  
25273

**22 mm**  
SKU 070132 **19<sup>99</sup>**  
25300

**26 mm**  
SKU 919500 **19<sup>99</sup>**  
25278

**27 mm**  
SKU 919497 **19<sup>99</sup>**  
25279



### 6 Piece Crank Bolt Socket Set **OEM TOOLS**

SKU 919501 **99<sup>99</sup>**  
25276

- Includes: 17, 19, 21, 22, 26 and 27 mm Deep Counter-Weighted Sockets
- Provides Increased Torque to Break Loose Stubborn Crank Bolts
- Applications: Honda-Acura, Models: Accord, Civic, Pilot, CRV, Odyssey, CL TL Integra, MDX, Vehicles. Plus Toyota-Lexus, Models: Camry, Corolla, 4Runner, Sequoia, ES300, LS400 Vehicles and More
- Constructed with Durable Chrome Moly Steel

### Universal Pulley and Fan Clutch Holder **OEM TOOLS**

SKU 547013 **64<sup>99</sup>**  
27281

- Fits Many Different Fan Clutches, Cam and Crank Pulleys with Slots or Holes Adjustable Diameter: 1-1/2" to 8-5/8" Pin Sizes: 6-10 mm, 8-11 mm, 10-12 mm and 11-16 mm
- Comes in Blow Mold Case



### 5 Piece Master Cam/Timing Gear Clamp Set **OEM TOOLS**

SKU 383452 **24<sup>99</sup>**  
27210

- Covers Most Single, Twin Cam and Quad Cam Engines
- Locks Camshaft to Hold Valve Timing During Timing Belt Replacement



### Ford Cam Tool 1.6 Liter **OEM TOOLS**

SKU 1103640 **29<sup>99</sup>**  
37380

- Designed to Hold the VCT Sprockets in Position During Timing Belt Installation or Camshaft Service
- Alignment Tool Services: Ford Fiesta (2011 to 2014), Ford Escape (2013 to 2014), Ford Fusion (2013 to 2014), Ford Transit (2013 to 2014)



### Ford 2.0 L, 2.3 L, 2.5 L Cam Tool Kit **OEM TOOLS**

SKU 626108 **14<sup>99</sup>**  
24448

- Applications: 2.0 L DOHC Engines Found in Ford and Mercury (1994 to 2003), 2.5 L DOHC, 2.3 L DOHC 4V and 2.0 L DOHC Engines in Ford, Mercury and Mazda (2004 to 2012) and 2.0 L DOHC Engines in Ford Probe (1993 to 1994)



### Ford Timing Chain Locking Wedge Tool **OEM TOOLS**

SKU 012647 **19<sup>99</sup>**  
24207

- For 2005-14 5.4 L and 4.6 L 3V OE Type Tool Allows for Easy Cam Changes without Removing the Timing Cover
- Compact and Easy to Use
- OE Type Tool
- For 5.4 L and 4.6 L 3V (2005-2014)



### DOHC Cam Lock Holder *Lisle*

SKU 291419 **59<sup>99</sup>**  
LIS36880

- This Versatile Tool Easily Locks and Holds Both Camshaft Sprockets Firmly in Place
- Preserves the Engine Timing During Belt or Chain Replacement



### Pilot Bearing Puller **OEM TOOLS**

SKU 775523 **22<sup>99</sup>**  
25089

- Use to Pull Pilot Bearing from End of Crankshaft
- Plate Prevents the Jaws from Spinning When Force is Applied
- Spread Range: 1/2" to 1-1/2"
- Reach Range: 3/16" to 11/4"



### Pilot Bearing Puller Attachment **OEM TOOLS**

SKU OUTSIDE BUY/EPO **18<sup>99</sup>**  
27059

- Use with OEMTOOLS 37033 and 27202 Slide Hammer Pullers
- Threaded with Both 5/8" x 18 and 3/4" x 16 Threads to Fit Most Slide Hammers



For Outside Buy/EPO, Call 901-300-4878

### Ford Master Timing Kit *CTA*

SKU OUTSIDE BUY/EPO **259<sup>99</sup>**  
CTA2221

- Includes: Harmonic Balancer Holder, Camshaft Alignment Tool, VCT Alignment Tool, Crankshaft Positioning Tool, Crankshaft Vibration Damper Alignment Tool, 3 Pc. Wedges and Camshaft Timing Kit
- Services Ford, Mazda and Lincoln 1.4 L, 1.5 L, 1.6 L, 2.0 L, 2.3 L, 2.5 L, 3.0 L and 3.5 L Engines



For Outside Buy/EPO, Call 901-300-4878

### Flywheel Turner **OEM TOOLS**

SKU 1207891 **19<sup>99</sup>**  
25556

- Holds Flex Plates and Fly Wheels to Allow Clutch, Transmission and Crankshaft Service
- Spring Tensioned to Keep the Wrench Securely Engaged
- Sure Grip Handle



### Flywheel Locking Tool **OEM TOOLS**

SKU 1335793 **27<sup>99</sup>**  
25557

- Locks Flywheel in Place When Removing Harmonic Balancer on 6.6 L Duramax Engines with Allison Automatic Transmissions
- Saves Time by Securing the Flywheel at the Transmission as an Alternative of Having to Remove the Starter for Water Pump Replacement
- Use 36 mm 12 Point Socket with 3/4" Square Drive to Remove Harmonic Balancer Bolt and Retorque on Installation
- Toothed Pieces with Screws Work with Duramax 4500/5500 Trucks



### Universal Camshaft Bearing Tool **OEM TOOLS**

SKU 191677 **199<sup>99</sup>**  
27143

- Removes or Inserts Camshaft Bearings in Nearly All Engines
- Set Includes: Driving Shaft, Driving Shaft Extension, Expander Unit, 5 Split Driving Plugs, 2 Driving Collars and Centering Cone
- Easy on Bearings
- Range: 1.125" to 2.69"



# ENGINE SERVICE

## Valve & Cylinder Head Tools

### Combustion Leak Detector

**OEM TOOLS**

SKU 1103608 **29<sup>99</sup>**  
37145

- Test for Internal Combustion Leaks on Gasoline Engines
- Fluid Color Changes to Yellow When a Combustion Leak is Present
- Comes in a Sturdy Blow Mold Case
- Not for Use with Diesel Engines



### Combustion Leak Detector Fluid (8 Oz.)

SKU 391381 **9<sup>99</sup>**  
25739



**STORE STOCKED**

### Flexible Air Valve Holder

**OEM TOOLS**

SKU 1392465 **16<sup>99</sup>**  
25029

- For 14 mm and 18 mm Spark Plug Holes
- 14" Flexible Hose Reaches into Tight Areas



### Valve Keeper Remover and Installer Kit

*Lisle*

SKU 011658 **119<sup>99</sup>**  
LIS36050

**Makes Valve Component Disassembly and Reassembly Fast and Easy**

- For Use with Valve Stems from 4.5 to 7.5 mm and 5/16" to 3/8"
- Magnet in Tool Body Captures Keepers
- New Smaller Size Works on Toyota 4 Cylinder and Chrysler New World Engine



### Lever Valve Spring Compressor

**OEM TOOLS**

SKU 662780 **59<sup>99</sup>**  
24676

- Lever Action Stays Compressed for Easy Valve Lock Removal
- Included Adapters Fit Valve Retainer Diameters from 1" (25 mm) to 1-3/16" (30 mm)
- Compression Range from 1-3/8" to 5-5/8" (35 mm to 142 mm)



### Hydraulic Valve Lifter Puller

**OEM TOOLS**

SKU 424904 **22<sup>99</sup>**  
27146

- Use for Removing Many Valve Lifters from Engine Block



### Ford Valve Spring Compressor

**OEM TOOLS**

SKU 626111 **24<sup>99</sup>**  
24434

- Applications: 1991 to 2004 Ford Vehicles with 4.6 L, 2V, V8 Engines; 4.6 4V, 5.4 V8 and 6.8 V10
- Works with Engine Removed or Installed, Cylinder Head On or Off
- Not for Triton 5.4 3V



### Ford Valve Spring Compressor for 3-Valve Engines

**OEM TOOLS**

SKU 814391 **42<sup>99</sup>**  
24429

- Designed to Compress the Valve Spring without Removing the Camshaft While Servicing the Cylinder Head in Ford 3-Valve Engines
- For Use with Ford 3-Valve 4.6 L and 5.4 L Engines



### Push Rod Remover

*Lisle*

SKU 459100 **29<sup>99</sup>**  
LIS48300

- Redesigned for Newer 3.5 L and 3.6 L GM Engines - Also Works on GM V6 2.8L, 3.1 L and 3.4L
- Quickly Removes Push Rods to Replace the Intake Gaskets without Removing Rocker Arms



### Torque Adapter, Diesel Head Bolt, Ford 6.0 L Power Stroke® Engines

**OEM TOOLS**

SKU 298191 **18<sup>99</sup>**  
24208

- Eliminates the Need to Remove the Truck/Van Cab from the Chassis to Access the Rear Head Bolts
- Eliminates the Need to Remove the Evaporator Housing, Saving 2 Hours of Time and the Additional Cost of Refrigerant Added During A/C Recharging
- Prevents Damage to the Rear Heat Shield
- Use with OEMTOOLS® 27309 3/4" Drive Torque Wrench and OEMTOOLS® 22398 18 mm Socket



### 24" Straight Edge

**OEM TOOLS**

SKU 949552 **41<sup>99</sup>**  
25355



- Use with a Feeler Gauge to Inspect for Distortion on Engine Blocks, Cylinder Heads, Fly Wheels, Main Bearing Saddles, Cam Bearing Saddles, Cam Covers and Bell Housings
- Constructed with 1/4" Thick Cold Rolled Steel
- Precision Ground Edge to +/- 0.001"
- Durable Powder-Coat Finish
- Hang Hole for Convenient Storage
- Includes Reusable Protective Edge



## Engine Cylinder Hones

### BC 180SC Flex-Hone Tool Kit

SKU 213154 **239<sup>99</sup>**  
BRM14353

- 10 Piece Kit Features Flex-Hone Sizes: 10 mm, 1/2", 5/8", 3/4", 7/8", 1", 1-1/4", 1-1/2", 1-3/4" and 2"
- Complimentary Snap Back Hat, 1/2 Pint of Flex-Hone Oil and 1GB Flash Drive



**BRM**

**OEM TOOLS**  
MADE FOR MECHANICS

# THE SPECIALTY TOOLS YOU NEED



SKU	Part #	Product	Cylinder Diameter		Price
			Metric	SAE	
341226	BRMBC30018	Flex-Hone™ GB	76 mm	3"	<b>54.99</b>
341232	BRMGB31412	Flex-Hone™ GB	83 mm	3-1/4"	<b>54.99</b>
341239	BRMGB31212	Flex-Hone™ GB	89 mm	3-1/2"	<b>59.99</b>
341317	BRMGB33412	Flex-Hone™ GB	95 mm	3-3/4"	<b>64.99</b>
341325	BRMGB41812	Flex-Hone™ GB	105 mm	4-1/8"	<b>69.99</b>
341332	BRMGB45812	Flex-Hone™ GB	118 mm	4-5/8"	<b>69.99</b>

**ADDITIONAL SIZES AVAILABLE - CALL US AT 901-300-4878 OR VISIT AZTOOL1.COM**

## Harmonic Balancer Tools



### Harmonic Balancer Puller Kit

SKU 818738 **39<sup>99</sup>**  
25090

Unique Jaw and Returning Springs for Easy Positioning of the Puller

- Includes: Puller Body, 3 Jaw Puller, 3 Jaw Retaining Pins, 3 Wave Washers, Pressure Screw
- Insert Rods: 4", 5-13/32", 6-1/2" and 7-13/32"
- Used on Many GM, Ford, Mitsubishi and Chrysler Engines



### Harmonic Balancer Puller



SKU 1103576 **24<sup>99</sup>**  
37187

- Includes: Yoke, Pressure Screw and Pulling Screws
- Floating Swivel Prevents Damage to Shaft Ends
- Ideal for Any Shop or Garage
- Pulling Balancers and More
- Heat-Treated for Strength and Durability

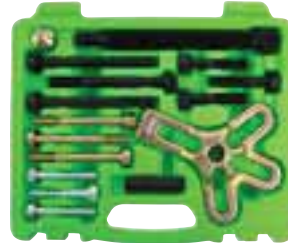

### Long Reach Harmonic Balancer/Pulley Installer for GM, Ford and Chrysler



SKU 1103550 **44<sup>99</sup>**  
37306

- Use to Install Crank Pulley or Underdrive Pulley on Many Late Model Ford, GM, Dodge and Chrysler Vehicles with V8 and V6 Engines
- Includes: M16 x 2.0 mm (GM), M14 x 1.5 mm (Dodge, Chrysler and Jeep), M12 x 1.75 mm (Dodge Chrysler and Jeep) and M12 x 1.5 mm (Ford)



### Universal Pulley and Fan Clutch Holder



SKU 547013 **64<sup>99</sup>**  
27281

- Fits Many Different Fan Clutches, Cam and Crank Pulleys with Slots or Holes
- Adjustable Diameter: 1-1/2" to 8-5/8"
- Pin Sizes: 6-10 mm, 8-11 mm, 10-12 mm and 11-16 mm
- Comes in Blow Mold Case



### Harmonic Balancer Installer



SKU 1103603 **39<sup>99</sup>**  
37144

- Use to Properly Install Harmonic Balancers without Damage
- Thread Adapters: 12 mm x 1.5, 14 mm x 1.5, 16 mm x 2.0, 7/16" x 20, 1/2" x 20, 9/16" x 18, 5/8" x 18, 3/4" x 16

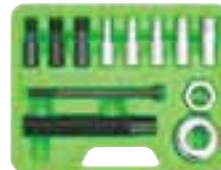

### GM Harmonic Balancer Puller



SKU 213102 **59<sup>99</sup>**  
25264

Time Saving Tool, No Need to Remove Radiator

- Designed to Remove Harmonic Balancers without Tapped Holes
- GM Applications: 5.3 L, 5.7 LS1, 6.0 LS2, 6.2 LS3, 7.0 L
- Chrysler/Jeep/Dodge: 3.5 L V6, 3.6 L V6, 4.7 L V8, 5.7 L V8 and 6.1 L V8



### Flywheel Locking Tool



SKU 1335793 **27<sup>99</sup>**  
25557

- Locks Flywheel in Place When Removing Harmonic Balancer on 6.6 L Duramax Engines with Allison Automatic Transmissions
- Saves Time by Securing the Flywheel at the Transmission as an Alternative of Having to Remove the Starter for Water Pump Replacement
- Use 36 mm 12 Point Socket with 3/4" Square Drive to Remove Harmonic Balancer Bolt and Retorque on Installation
- Toothed Pieces with Screws Work with Duramax 4500/5500 Trucks



### Honda/Acura Crank Damper Holder Tool



SKU 1069101 **39<sup>99</sup>**  
26507

- For Removal and Installation of the Crank Bolt on Honda/Acura Engines
- Use on Honda and Acura Engines (1990 - Newer)
- Designed to Hold Crankshaft Pulley to Install/Remove Crankshaft Pulley Bolt
- 50 mm Hex
- 1/2" Drive Works with Ratchet or Breaker Bar



### 2.7/5.2 L Ford EcoBoost Long Reach Harmonic Balancer/Installer

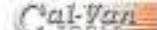

SKU 1392336 **49<sup>99</sup>**  
CAL38710

- Designed to Achieve Easy Installation of Harmonic Balancers on Ford EcoBoost
- Can Be Used On 2.7 L, 3.0 L, 3.3 L and 5.0 L Engines in Ford/Lincoln Cars, Trucks and SUV



### Ratcheting Harmonic Balancer Pulley Puller



SKU 1189050 **89<sup>99</sup>**  
CAL38000

- Eliminates Need to Remove the Radiator
- Push Turn Click Design
- No Need for Bolts
- Applications: FORD 5.0 Coyote, GM 5.3 L, 5.7 (LS1), 6.0 (LS2), 6.2 (LS3), 7.0 L and Most Three and Six-Spoke Harmonic Balancers/Pulleys



## Hex Oil Pump Primers



- Used to Prime the Lubricating System of a Rebuilt Engine Prior to the First Start, Preventing a Dry Start
- Connects to the Oil Pump Shaft Through the Distributor Hole
- For Use with 3/8" Reversible Drill



**Ford 5/16"**  
SKU 534545 **14<sup>99</sup>**  
27062

**Ford 1/4"**  
SKU 534537 **29<sup>99</sup>**  
27061

## Piston Tools

### Piston Ring Compressor

SKU 013641 **14<sup>99</sup>**  
24682

- 1-1/2" Deep, Low Friction Wrinkle Band
- Fits 3" to 5" Pistons



### Piston Ring Expander Pliers

SKU 003509 **22<sup>99</sup>**  
25083

- Eliminates Piston Ring Damage and Distortion During the Installation and Removal Process Dipped Rubber Handles for Improved Grip
- Diameter Range: 3-1/8" (80 mm) to 4-5/8" (120 mm)



# ENGINE SERVICE

## Diagnostic

### Compression Tester Gauge Set

SKU 1103601 **29<sup>99</sup>**  
37138

- Use to Test Compression 0 to 300 psi on 14 mm and 18 mm Spark Plug Ports and Determines Engine Mechanical Condition



### 8 Piece Noid Light Set

SKU 1103589 **24<sup>99</sup>**  
37161

- Includes: GM TBI, GM SCPI, GM PFI, Ford TBI, GEO TBI, Bosch PFI, Bosch Type 2 and GM Multec 2
- See-Through Design to Check Electrical Pulses



### Vacuum Pump Tester Power Steering and Brake Bleeder Set

SKU 1103570 **39<sup>99</sup>**  
37070

- Brake Bleeding Kit Bleeds Brakes, Clutches or Other Hydraulic Systems
- Kit Includes: Vacuum Pump Reservoir Jar with Transfer Lid, Storage Lid, Brake Bleeding Adapter Package, Steering Pump Adapters and Tubing



### Exhaust Back Pressure Tester/Gauge

SKU 1103604 **54<sup>99</sup>**  
37263

- Oxygen Sensor Adapter is M12 and M18 Thread
- 6' Hose Allows User to Test from Driver's Seat
- Test for Restricted Exhaust Systems



### Gas Engine Combustion Leak Tester

SKU 1103608 **29<sup>99</sup>**  
37145

- Test for Internal Combustion Leaks on Gasoline Engines
- Fluid Color Changes to Yellow When a Combustion Leak is Present
- Designed for Professional Auto Mechanics and Heavy Duty Applications
- Not for Use with Diesel Engines
- Use with 25739 Test Fluid



## Alternator Tools

### Alternator Decoupler Pulley Tool Kit

SKU 300124 **19<sup>99</sup>**  
27261 REG. \$24.99

- Works on Both Overriding Alternator Decoupler (OAD) and One-Way Clutch (OWC) Pulleys
- Tools May Be Used While the Alternator is On or Off
- Includes 2 Pulley Sockets and 3 Shaft Bits
- Comes in a Sturdy Blow Mold Storage Case



Offer Good Through June 30, 2025

**SAVE \$5**

### Alternator Decoupler Pulley Service Set

SKU 1103629 **39<sup>99</sup>**  
37275

- Removes and Installs Many Alternator Decoupler Pulleys on the Most Popular Vehicles
- Works on Both Overriding Alternator Decoupler (OAD) and One-Way Clutch (OWC) Pulleys

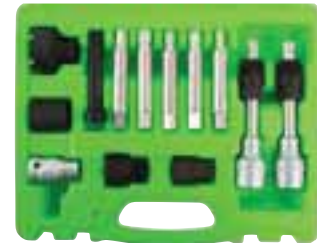

## Exhaust Tools

### Exhaust Donut Stretcher

SKU 390901 **15<sup>99</sup>**  
25543

- Easily Grabs onto Mounting Rubber Rings or Doughnut Used on Many Exhaust Systems
- Features an Offset J-Hook
- Large Coated Handle for Comfort

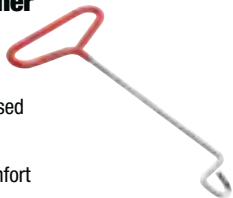

### Exhaust Manifold Spreader Set

SKU 504028 **18<sup>99</sup>**  
25253TWO

- Use for Reinstalling the Manifold on Small-Block Chevrolets
- Simple Way to Expand Warped Manifold to Align Bolt Holes
- Helps Prevent Cross-Threading of Manifold Bolts
- Works Best When Used in Pairs or Install Before Removing Manifold to Prevent Misalignment



### 1-1/2" x 2-7/16" Tailpipe Expander

SKU OUTSIDE BUY/EPO **24<sup>99</sup>**  
27027

- Extra Long Hex Bar for Convenience



For Outside Buy/EPO, Call 901-300-4878

### Tailpipe Cutter

SKU OUTSIDE BUY/EPO **29<sup>99</sup>**  
27045

- Used to Cut Tail Pipe Range 3/4" to 3-1/4" (19-83 mm)
- Cushion Grip Handles
- Designed for Both On and Off Cutting



For Outside Buy/EPO, Call 901-300-4878

### Manifold Drill Template - Ford 2V and 3V

SKU 213145 **69<sup>99</sup>**  
25251

- Designed to Remove Broken Exhaust Manifold Studs
- For Ford Triton 2V and 3V Engines - 4.6L, 5.4 L and 6.8 L V10
- Drill Depth Gauge Marked on Each Adapter
- Interchangeable 2V and 3V Adapters
- Hi-Vis EVA Tray for Easy Storage and Organization
- Includes: Template, 2V Adapter, 3V Adapter, 2 Stud Alignment Pins, 3/16" and 1/8" Double-Sided Drill Bits and Stud Extractor



### Exhaust Pipe Stretcher Kit

SKU 080137 **369<sup>99</sup>**  
LIS17350

- Expands All Types of Exhaust Pipe, Including Stainless Steel, from 1-5/8" to 4-1/4" in Size
- Use with Impact Wrench to Quickly Stretch Pipes



### Manifold Drill Template for GM EcoTec3 5.3 L and 6.2 L

SKU 1125865 **169<sup>99</sup>**  
LIS71650

- Removes Broken Exhaust Manifold Bolts without Damaging the Cylinder Head
- Tapered Bolts Allow You to Move from Hole to Hole without Moving Base Plate
- Screw Extractor Removes Broken Bolts
- Includes Bushing Drill Guide When Extractor Cannot Be Used





## STOP the Knock!



Cam phaser knock on 4.6/5.4 L 3V engines is common in older models and can lead to bigger problems if not fixed. There are millions of trucks on the road with this problem, but until now, there have been few good options to permanently help fix the knock. This kit helps to eliminate any knocking noise heard from the front valve cover/timing cover related to the phasers. These all-in-one kits correct the cam phaser knock on ONE engine.

### Cam Phaser Noise Repair Kits Include: Ford Cam Phaser Noise Repair Kit

- Wedge Tool for Easier Installation
- Programmer with OBD-II Cable
- 2 OEM Quality Phaser Bolts
- 2 Lock Outs

SKU **OUTSIDE BUY/EPO** **699<sup>99</sup>**  
LMEF1503V

- Fits Ford OEM Cam Phaser

**Stop Saying "No" to Business and Be Confident Your Customers Will Be Satisfied!**



**This Kit is the Only True, Long Term Repair for Ford Cam Phaser Noise on the Market**

Ford, Livernois and logos featured or referred to on this page are the property of their respective trademark holders | For Outside Buy/EPO, Call 901-300-4878

### Fan Clutch Tools

#### Fan Clutch Wrench Set

SKU **1103596** **59<sup>99</sup>** REG. \$79.99  
37141

- Works on Many of the Ford, Mazda, Dodge, Lincoln, Mercury and Jeep Makes and Models with the Original Fan Clutch Assembly
- Includes Wrench Sizes: 40 mm, 48 mm, 54 mm, 68 mm, 72 mm, 76 mm and 83 mm



Offer Good Through June 30, 2025

#### Universal Fan Wrench Set

SKU **080554** **89<sup>99</sup>**  
LIS43600

- A Nearly Universal Fan Clutch Wrench Set for Use on the Most Popular Applications
- Hooked Wrench Design Holds Nuts and Bolts, Allowing the Technician to Easily Tighten/Loosen the Other Bolts
- Double-Sided Spanner Style Holding Wrench Will Hold Pressed-On Pulleys on Many GM, Jeep and Dodge Vehicles



#### Pneumatic Fan Clutch Wrench Set

SKU **291409** **219<sup>99</sup>**  
LIS43300

- Quickly Removes and Installs Fan Clutch When Repairing the Water Pump or Fan Clutch
- Includes Wrench Sizes: 32 mm, 36 mm, 40 mm; 7/8", 1-7/8" and 2"

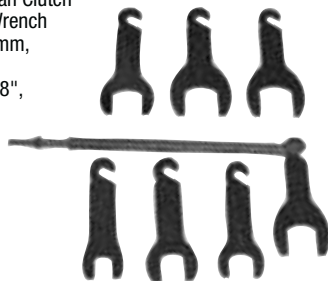

#### Fan Clutch Service Set for Mercedes-Benz and BMW

SKU **512958** **244<sup>99</sup>**  
27224

- Removes Lock Nuts on Thermo Viscous Fans Found on Mercedes-Benz, BMW and Many Ford Models
- Special Open-Ended Spanner to Allow Removal and Replacement of the Radiator Fan Hub
- The 3-in-1 Design Allows Servicing of 3 Separate Areas of Repair, Eliminating the Need for 3 Different Tools
- Hub Securing Bar - Used for Securing Water Pump Hub from Rotating During R&R of Fan Clutch Nut
- Applicable: Mercedes M103, 104, 111, 119, 120 OM 602, 603, 605, 606; the 10 mm is Used for Adjusting A/C Belt Tension and R&R of Idler Pulley on Models 420, 560 with V-819 (1986 and Newer)
- Applicable: Mercedes M103 (6 CYL, M104 (6 CYL 4 VLV), M119 (8 CYL 4 VLV) M120 (12 CYL 4 VLV)



### Pulley and Fan Clutch Holders

#### Fan Clutch Holding Tool

SKU **209526** **49<sup>99</sup>**  
27171

- For Fan Clutch Repair and Service
- Holds Water Pump Pulley while Servicing Fan Clutch Adjustable Jaws
- Fits Most Water Pump Pulley Bolt Patterns, Including Pressed-On Pulleys
- Jaws Will Lock in Place, Securing Water Pump Bolts
- Longer Handle Provides Leverage for Extra Torque



#### Universal Pulley and Fan Clutch Holder

SKU **547013** **64<sup>99</sup>**  
27281

- Fits Many Different Fan Clutches, Cam and Crank Pulleys with Slots or Holes
- Adjustable Diameter: 1-1/2" to 8-5/8"
- Pin Sizes: 6-10 mm, 8-11 mm, 10-12 mm and 11-16 mm
- Comes in Blow Mold Case



### Stretch Belt Tools

#### Stretch Belt Installation Tool

SKU **227301** **18<sup>99</sup>**  
24363

- Works on Both Large and Small Pulleys
- Clamping Jaw Allows User to Position Serpentine Belt without the Belt Slipping Out of the Tool



#### Stretch Belt Remover and Installer

SKU **255866** **34<sup>99</sup>**  
LIS59370

- Unique Magnetic Faces Hold the Tool in Place on the Pulley
- Compact, One Piece Tool Can Be Used on the Front or Back Side of the Pulley



# CHASSIS & SUSPENSION

## Ball Joint Service Kits

### XL C-Frame Ball Joint Press Set

SKU 1142924 **109<sup>99</sup>**  
25105

- Ideal for Pressing Out Larger Ball Joints on Pick-Up Trucks: Toyota Tacoma and Tundra, Chevrolet 2500-3500 and Tahoe, Dodge Ram 2500-3500 and Ford F350-F550
- Extended C-Frame Allows Use of Multiple Larger Adapters That Standard C-Frame Presses Won't Fit
- C-Frame Constructed with Heavy Duty Forged Steel for Strength and Durability
- For Use with OEMTOOLS® Ball Joint Press Kits and Adapter Sets



### 74 Piece Master Ball Joint Press Kit

SKU 1207895 **799<sup>99</sup>**  
37388

- Adapters for Almost Every Car, Van, SUV and Light Duty Truck
- Comprehensive Kit with 70+ Adapters and C-Frame
- Tough Heavy Duty C-Frame is Built to Last
- 2 Heavy Duty Molded Cases are Designed for Storage and Mobility



OEMTOOLS®

Easy to Read Manual for Finding Adapters Quickly and Easily



**BONUS**  
VALUE: \$79.99

### Hydraulic Ball Joint Separator

25219

With Purchase of: 37388



Offer Good While Supplies Last Through June 30, 2025

### 21 Piece Master Ball Joint Press Set

SKU 1142406 **124<sup>99</sup>**  
25104

- Removes and Replaces Press-Fit Upper and Lower Ball Joints on 2-Wheel Drive (2WD) and 4-Wheel Drive (4WD) Vehicles
- Includes Adapters with Specialized Cut-Outs to Maneuver Around Obstructions
- Includes Adapters Needed for Removing Upper and Lower Ball Joints on GM, Ford and Chrysler 2WD and 4WD Light-Duty Trucks, Vans and SUVs
- Heavy Duty Forged Steel Alloy C-Frame for the Toughest Jobs — Ideal for Seized Joints



### Master Ball Joint Installer/Remover Adapter Set

SKU 1103612 **87<sup>99</sup>**  
37310

- Includes All the Receiver Tubes and Removing/Installing Adapters Needed to Work on Many GM, Ford and Chrysler 2 and 4 Wheel Drive Pick-Ups, Vans and SUVs
- Works on Press-Fit Upper and Lower Ball Joints
- For Use with OEMTOOLS® Ball Joint Press Kits and Adapter Sets



### Ball/U-Joint Press with 4WD Adapter Set

SKU 1103607 **87<sup>99</sup>**  
37089

- Remove and Replace Ball Joints on Many Vehicles
- C-Clamp Frame Press Also Removes and Replaces U-Joints
- Includes Adapters to Service 1/2 to 3/4 Ton 4 Wheel Drive Vehicles Equipped with Dana 44 Series Front Axle



## Ball Joint Tools

### Ball Joint Separator

SKU 1340232 **29<sup>99</sup>**  
37308

- Used for Separating the Ball Joint from the Spindle Support Arm on Domestic and Import FWD Vehicles
- Adjustable for Different Size Ball Joints
- Max. Opening Range: 1-1/8" to 2-1/8"



### Low Profile Ball Joint Separator

SKU 1245676 **44<sup>99</sup>**  
25112

- Designed for Tight Access Where Many Ball Joint Separators Won't Fit
- For 2005+ Ford, Lincoln and Mercury Applications
- Impact Rated



### Polaris ATV Ball Joint Tool

SKU 1142310 **49<sup>99</sup>**  
24683

- For Removal and Installation of Upper and Lower Ball Joints on Sportsman XP, RZR and Ranger ATVs



OEMTOOLS®

### Hydraulic Ball Joint Separator

SKU 177718 **79<sup>99</sup>**  
25219

- Hydraulic Ram Rated to 8 Tons
- Jaw Capacity: 56 mm (2.25")
- Jaw Width: 22 mm (0.86")

Fast. Safe. Efficient.



### Ball Joint Separator

SKU 1207880 **22<sup>99</sup>**  
26553

- Separate Ball Joints from Spindle Support Arm
- Adjustable for Different Size Ball Joints
- Max. Opening Range: 1-1/8" to 2-1/8"
- Fork Opening Measures 7/8"
- Steel Construction with Black Oxide Pins
- Comes in a Sturdy Blow Mold Case



### 3/4" Drive Ball Joint Impact Socket 2-9/64"

SKU 462494 **14<sup>99</sup>**  
24215

- Used on Chrysler/Dodge Cars, Light Trucks and Vans

### 3/4" Drive Ball Joint Impact Socket 1-59/64"

SKU 662809 **14<sup>99</sup>**  
24238

- Used on Chrysler/Dodge Mid-Size Cars, Light Trucks and Vans



# CHASSIS & SUSPENSION

TO ORDER, contact your Commercial Sales Manager or go to [AutoZonePro.com](http://AutoZonePro.com)

CHASSIS & SUSPENSION

## Spring Compressors



### Floor Mounted Strut Compressor

SKU 1405961  
37037 **299<sup>99</sup>**

- 2,200 Lb. Capacity
- Easy-to-Adjust Bracket Conforms to Spring Rate and Diameter
- Handles Spring Coils 3.5" to 8.75" and Up to 5/8" Diameter
- Max. Spring Height: 19"
- Can Be Securely Mounted to the Floor



Bracket Design Easily Adjusts to Accommodate a Wide Range of Vehicle Strut Sizes

No Special Adapters Required

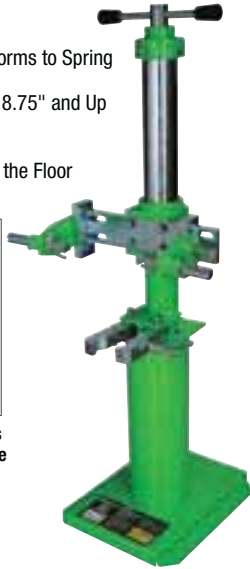

Floor Mounting Hardware Not Included

### Model 7600 Strut Spring Compressor



SKU 547959  
BRA7600 **1,299<sup>99</sup>**

- Handles the Toughest Applications
- Min./Max. Spring Diameters: 3.5"/11.5"
- No Adapters Required

OEM Approved by Major Automakers

### Cart for BRA7600

SKU 547960  
BRA00-0137 **599<sup>99</sup>**

### Bench Mount for BRA7600

SKU 547962  
BRA05-0125 **129<sup>99</sup>**



### Mechanical Strut Compressor



SKU OUTSIDE BUY/EPO  
QSPMSC-1000

**Call for Price**

- Designed to Handle Any Size Spring and Strut Assembly
- Adjustable Extra Strong Clamps for a Perfect Grip
- Top Mounted Tool Tray
- Standard Wall Mount
- Safety Guard Included
- Optional Floor Mount and Third Hand Support Kits

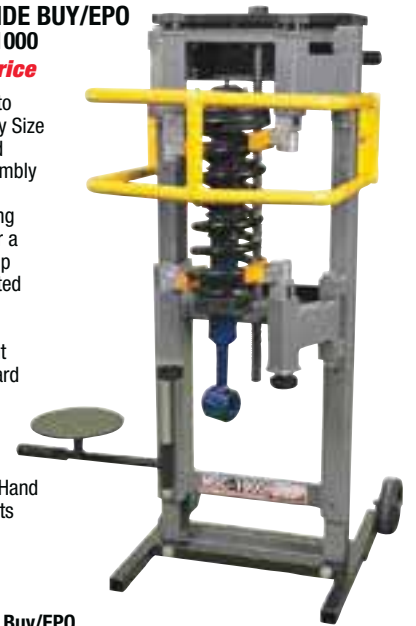

For Outside Buy/EPO, Call 901-300-4878

### Coil Spring Compressor



SKU 1103643  
37035 **49<sup>99</sup>**

- Use to Safely Compress the Coil Spring on Most Cars and Light Trucks
- Can Also Be Used When Installing Coil Spring Spacers



### Coil Spring Compressor Set



SKU 1103614  
37200 **29<sup>99</sup>**

- Forged Construction for Strength and Durability
- Removes and Installs Coil Springs Quickly and Safely
- Compresses Coil Springs on Most Passenger Cars and Pickup Trucks



### Strut Spring Compressor



SKU 1207884  
37036 **39<sup>99</sup>** REG. \$49.99

**SAVE \$10**

- Used to Compress Strut Springs During Cartridge Replacement
- Safety Latches Lock Spring in Place During Compression Hooks are Forged and Center Screw is Hardened for Longer Life
- Thread Length: 9"
- Can Be Used with Varying Coil Diameters Up to 5/8"



Offer Good While Supplies Last Through June 30, 2025

## Suspension



### GM Upper Control Arm Knock Out Tool

SKU 420336  
24210 **22<sup>99</sup>**

- Services Chevrolet and GMC 1/2, 3/4 and 1 Ton, 2 and 4 Wheel Drive Trucks (1989 to 2001) and All Wheel Drive Chevrolet Astro and GMC Safari Vans (1990 to 2002)



## Shock Socket



### Volvo Shock Retaining Nut Strut Removal Socket Tool

SKU 300125  
24365 **19<sup>99</sup>**

- Remove and Install Top Shock Retaining Nut on Volvo Models
- Applications Include: Volvo C70 (1999-2004), Volvo S40 (2000-2004), Volvo S60 (2001-2004), Volvo S70 Non-Turbo (1999-2000), Volvo S70 Turbo (1999-2000), Volvo S70 AWD Turbo (1999-2000), Volvo S80 (1999-2004), Volvo S80 V8 (2007-2008), Volvo S80 Turbo (1999-2006), Volvo V40 (2000-2004), Volvo V70 (1999-2007), Volvo XC90 (2003-2010)



## Front End Service Kit



### 5 Piece Front End Service Kit

SKU 1267952  
26554 **76<sup>99</sup>**

- Large and Small Pitman Arm Puller for Ball Joint Application
- Two Ball Joint Separators
- Three Tie Rod Pullers



## Torsion Bar Tool



### GM, Ford, Chrysler Torsion Bar Tool

SKU 1103600  
37278 **49<sup>99</sup>**

- Safely Loads and Unloads 5-Lug, 6-Lug and 8-Lug GM, Dodge and Ford Torsion Bar Suspensions for Key Replacement
- Extended Long Reach "C-Clamp" for Use with 2011 and Higher GM Heavy Duty Trucks
- Includes Ford/Dodge Adapter



Prices subject to change without notice. Prices do not include applicable taxes, vehicles, tires, rims, installation or optional equipment as shown. Please do not return purchases to the store. For information regarding warranty, repair, or any questions or concerns, call 901-300-4878.

AZG0225

# CHASSIS & SUSPENSION

## Hub Bearing

### Front Hub Service Set

SKU 1204178  
68928

- Removes Front Hubs, Drums and Brake Rotors without Damaging the Wheel Bearing
- Fits Most Domestic and Import Vehicles with Independent Front Wheel Suspension
- Jaws Spread Up to 14" with a 5" Reach
- Forged Frame Is Rated to 7 Tons
- Includes Sturdy, Green Blow Mold Case



**149<sup>99</sup>**

REG. \$167.98

**SAVE \$17**

When You Buy the Kit

### Master Wheel Hub and Bearing Remover and Installer Set

SKU 1103635  
37342 **299<sup>99</sup>**

- For Removal and Installation of Front Wheel Hub on Most Vehicles
- Self Centering Design is Incredibly Durable and Easy to Use
- Works on Front, Rear and All-Wheel Drive Vehicles
- Heavy Duty Thrust Bearing Reduces Effort and Extends the Life of the Pressure Screw
- Includes: Adapter Shoes, Pusher Washers, Receiver Sleeves, Nut-Bolt and Heavy Duty Bearing

OEM TOOLS®



### Wheel Hub Removal Tool

SKU 1245618  
25749 **69<sup>99</sup>** REG. \$86.99

**SAVE \$17**

- Ideal For Removing a Frozen Hub Assembly without Damaging the Axle
- For Use on Many Axle Bolted Hubs Including Five, Six and Eight Lug Hubs
- Constructed from High-Quality, Impact-Resistant and Corrosion-Resistant Steel
- 2-5/8" Center to Center Hole Pattern
- 3/4" Steel Backing Plate and Reinforced Striking Plate for Long Life



### 23 Piece Hub Bearing Remover and Installer Set

SKU 094804  
27205 **229<sup>99</sup>**

- Removes and Installs Wheel Bearings with Steering Knuckle and Strut Assembly Still on the Vehicle
- Eliminates Need for Alignment



Offer Good While Supplies Last Through June 30, 2025

## Tie Rod Tools

### Master Inner Tie Rod Tool Set

SKU 344979  
27178 **89<sup>99</sup>**

#### Works on Both Small Cars and SUVs

- Tube Handle Has an Inner Diameter of 2.125" to Service Small Cars, Pickups and Large SUVs
- Includes 12 Crowfoot Style Adapters, Sizes: 29 mm, 1-3/16", 1-1/4", 32.5 mm, 1-5/16", 33.6 mm, 1-3/8", 1-7/16", 1-1/2", 38.4 mm, 40 mm and 42 mm



OEM TOOLS®

### Tie Rod End Remover

SKU 209525  
27175 **19<sup>99</sup>**

- Comes with Pressure Screw Tip Swivels for Damage Free Results
- Will Not Damage Tie Rod End Dust Boot
- Rust Resistant Finish



OEM TOOLS®

### Inner Tie Rod Tool Kit

SKU 217377  
27185 **44<sup>99</sup>**

- Removes and Installs Tie Rod End on Rack and Pinion Steering
- Includes: 3/16", 5/16" and 7/16" Adapters



OEM TOOLS®

### Inner Tie Rod Tool

SKU 291414  
LIS45750 **119<sup>99</sup>**

- 6 Sizes: 1-3/16", 1-1/4", 1-5/16", 1-7/16", 1-1/2" and 33.6 mm



LiSe

## Pitman Arm Puller

### Pitman Arm Puller for Light Trucks

SKU OUTSIDE BUY/EPO  
27170 **64<sup>99</sup>**

- Services Cars and Light Trucks 3/4 Ton
- Features Forged Adjustable Jaws and Two Clamp Bolts That Lock Jaws Together
- Pressure Screw Has Ball Head Designed for Striking



OEM TOOLS®

For Outside Buy/EPO,  
Call 901-300-4878

## Pickle Forks

### Stepped Pickle Fork Set

SKU 291410  
LIS41400 **79<sup>99</sup>**

- 6 Tools in One
- Includes: 11/16", 15/16", 1-1/8"
- Forks and 2 Handles



LiSe

### 5 Piece Tie Rod and Ball Joint Set

SKU 1103626  
37201 **49<sup>99</sup>**

- Used to Remove Tie Rods and Ball Joints
- Includes: 11" x 1-1/8", 11-3/4" x 1-5/8", 11-5/8" x 1-7/16", 16" x 11/16" and 16" x 15/16"

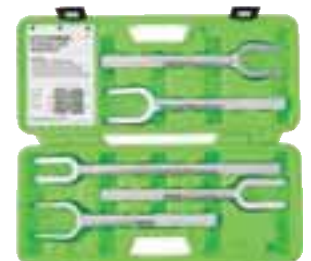

OEM TOOLS®

# CHASSIS & SUSPENSION

TO ORDER, contact your Commercial Sales Manager or go to [AutoZonePro.com](http://AutoZonePro.com)

CHASSIS & SUSPENSION

## CV Axle Nut Sockets

### 39 mm 12 Pt. Axle Nut Socket for Toyota

SKU 452638 LIS39650 **29<sup>99</sup>**

- Applications: 2008-2010 Toyota Land Cruiser, 2008-2010 Toyota Sequoia, 2007-2010 Toyota Tundra and 2008 Lexus LX 570



See AZTOOL1.com for Full Line of CV Axle Nut Sockets

## Axle Nut Socket Sets

OEM TOOLS®

- Includes Sizes: 29, 30, 32, 34, 35, 36, 38 and 39 mm **69<sup>99</sup>**

### 6 Pt.

SKU 1103577 37320



### 12 Pt.

SKU 1103460 37321



## Bushing Tool Set

OEM TOOLS®

### Manual Bushing Installation and Removal Tool Set

SKU 298214 27212 **249<sup>99</sup>**

- Comprehensive Kit for Fast and Effective Removal/Installation of Wheel Bearings/Suspension Bushings and Seals
- Allows the Technician to Service a Wide Range of Bushings without Removing Components from the Vehicle
- Comes with 20 Sleeves for Hundreds of Combinations
- External Sleeve Diameter: 44, 46, 48, 50, 52, 54, 56, 58, 60, 62, 64, 66, 68, 70, 72, 74, 76, 78, 80 and 82 mm

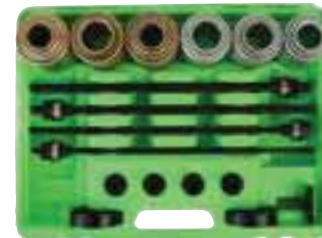

## Axle Tools

### CV Axle Puller Adapter

SKU OUTSIDE BUY/EPO 27058 **29<sup>99</sup>**

- Works with OEMTOOLS 37033, 37191, 27085, 27033 and Other Slide Hammer Pullers with 5/8" x 18 Threads



For Outside Buy/EPO, Call 901-300-4878

### CV Axle Popper Set

SKU 1189082 37305 **33<sup>99</sup>**

- Includes: Axle Shim Tool and Fork/Wedge Tool
- Length: 13-3/4"
- Used to Remove Axles from the Transmission, Ball Joints in the Suspension System and Tie Rods
- Fork Design Allows Mechanic to Exert Force Evenly on Both Sides of the Axle



### 5 Lb. Slide Hammer

SKU 1103572 37033 **54<sup>99</sup>**

- Use to Pull Bushings, Seals, Sleeves, Bearings, Flange-Type Rear Axles, Front-Wheel Drive Hubs, Dents and Pressed-In Bolts with Two or Three Jaw Puller Options
- Slide Rod is 3/4" x 16 Standard Threads



### 4WD Spindle Puller

SKU 143436 27104 **34<sup>99</sup>**

- Use with OEMTOOLS Slide Hammer 27033
- Fits Most Spindles 1-1/2", 1-5/8" and 2" on 4 Wheel Drive Vehicles
- Heat-Treated for Strength
- Will Fit on 2 Puller Size Shafts 1/2" x 20 Threads and 5/8" x 18 Threads



### Rear Axle Puller Set

SKU 094801 27202 **69<sup>99</sup>**

- Use for Flange-Type Rear Axle and Bearing Removal on Most Late Model Passenger Cars and Light Trucks
- Slide Rod and Adapters are 5/8" x 18 Standard Threads

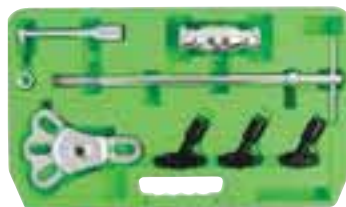

### Axle Spindle Threading Set

SKU 1103645 37233 **49<sup>99</sup>**

- Use to Clean or Repair Axle Threads
- Set Comes with a Special Twist Shape That Provides Easier and Quicker Work
- Sizes Included: M20 x 1.25, M20 x 1.50, M22 x 1.00, M22 x 1.50, M24 x 1.50, M24 x 2.00, 13/16" x 20 UNEF, 3/4" x 20 UNEF and 27 mm Extension Bar



## Seal Tools

### Transmission/Transaxle Plugs

SKU 298196 24490 **12<sup>99</sup>**

- Includes 5 Plugs to Seal Both Transmissions and Transaxles on Most Import and Domestic Vehicles
- Stepped Design for Retention and Positive Sealing
- Includes Side Gear Centering Pin for Ford Transaxles



### Bearing Race and Seal Master Driver Set

SKU 1103639 37119 **32<sup>99</sup>**

- Installs Most Standard Wheel Bearings and Races
- Includes Driver Sizes: 1.565", 1.750", 1.965", 2.325", 2.470", 2.555", 2.830", 2.995", 3.180" and Handle



### Universal Seal Installer Set

SKU 818737 25082 **34<sup>99</sup>** REG. \$44.99

- Knurled Long Handle
- Includes: 3" Driver, 2.5" Driver, Short Handle, Long Handle, Spider Insert, 5/16" x 1" Cap Screw, Large Spider, Small Spider and Washer
- Long Handle Provides Good Flexibility When Installing Pinion Seals

SAVE \$10



Offer Good While Supplies Last Through June 30, 2025

Prices subject to change without notice. Prices do not include applicable taxes, vehicles, tires, rims, installation or optional equipment as shown. Please do not return purchases to the store. For information regarding warranty, repair, or any questions or concerns, call 901-300-4878.

AZG0225

# CHASSIS & SUSPENSION

## Power Steering Bleeders

### Vacuum Pump Tester, Power Steering and Brake Bleeder Set

SKU 1103570 **39<sup>99</sup>**  
37070

- Includes: Vacuum Pump Reservoir Jar with Transfer Lid, Storage Lid, Brake Bleeding Adapter Package, Steering Pump Adapters and Tubing



## Power Steering Bleeder Set

SKU 434716 **21<sup>99</sup>**  
27311

### Reduce Comebacks

- Eliminate Trapped Air in Power Steering and Brake Systems Following Repairs or Fluid Changes
- Includes: 2 EPDM Tapered Rubber Adapters to Fit Most Power Steering Pumps and Reservoirs, Reservoir Bottle to Protect Hand Vacuum Pumps and 3 Sizes of Brake Bleeder Adapters
- Works with a Hand Vacuum Pump



## Drive Line Tool

### 1/2" Drive (12 mm) Ford Drive Line Impact Socket

SKU 420319 **19<sup>99</sup>**  
24212

- Applications Include Many Ford Drive Line Bolts
- 12 mm, 12 Pt.



## Power Steering Pullers

### Power Steering Pulley Remover/Installer - Ford, GM, Chrysler

SKU 1103578 **34<sup>99</sup>**  
37031

- Includes 2 Screws for Use on Most Ford, Chrysler, GM and VW Power Steering Pulleys
- Pulls Pulleys on GM Belt Driven Vacuum Pumps and Pressed-On Water Pump Pulleys of GM V6 Engines

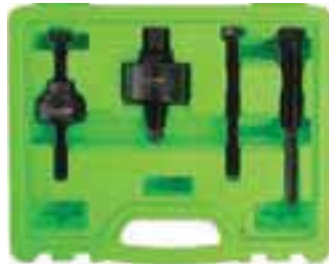

## Steering Wheel Puller

SKU 1103540 **39<sup>99</sup>**  
37182

- Designed for All Major Makes and Models
- Sizes Included: 1/4" x 28, 8 mm x 1.25, 5/16" x 18, 5/16" x 24, and 3/8" x 16

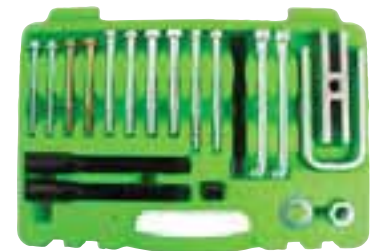

## U-Joint Tools

### U-Joint Pullers

- Easily Removes Seized U-Joint Cups on Most Passenger Vehicles and Light Duty Trucks
- Does Not Damage the Driveshaft, Yokes, Joints or Bearing Cups

### Automotive

SKU 949561 **59<sup>99</sup>**  
24539

- Bearing Cup Outside Diameter: 1" to 1.25"

### Intermediate

SKU 949565 **99<sup>99</sup>**  
24548

- Bearing Cup Outside Diameter: 1.25" to 1.7"

### Heavy Duty

SKU 041474 **124<sup>99</sup>**  
24538

- Bearing Cup Outside Diameter: 1.5" to 2.2"



### Automotive Bearing Cup Installer

SKU 949571 **54<sup>99</sup>**  
24549

- For the Installation of Bearing Cups on Light-Duty and Medium-Duty U-Joints
- Efficiently Install 2 Bearing Cups in One Process
- Contact Points Feature Magnets to Retain Bearing Cups During Operation



## Spindle Nuts

### GM Axle Hub Nut Socket

SKU 298219 **24<sup>99</sup>**  
25967

- Applications: GMT900 Silverado, Sierra HDCS, 2-Wheel (2WD) and 4-Wheel (4WD) Drive Cheyenne, Silverado, Escalade, Sierra and Avalanche Trucks with 10.5" or 11.5" Ring Gear
- Has 9 Pins to Fit GM New Style Retaining Nuts
- Unapproved Methods Can Damage the Bearing or Result in Shorter Service Life



### Dodge Hub Locknut Socket

SKU 344964 **29<sup>99</sup>**  
25968

- Fits Dodge 1/2-Ton Pickup Trucks (1994-Newer) with Dana 44 Front Axle and Dana 60 Axle with a Vacuum Disconnect
- Designed to Accommodate the 1-11/16" (43 mm) Wheel Bearing Retaining Nut Which is Recessed into the Hub



### Toyota 4 Pin Hub Locknut Socket

SKU 298224 **17<sup>99</sup>**  
25969

- Serves High Torque Locknuts on Toyota 4WD Vehicles Having Free Wheel (Lock Out) Hubs
- Tacoma (1995-Newer); T100 and 4Runner (1996-Newer)
- Improved Design with Solid Pins for Increased Durability



## Ford Rear Axle Nut Wrench

SKU 1392337 **29<sup>99</sup>**  
27353

- Serves 2003-Newer Ford F-250, F-350 and F-450 Super Duty Trucks with 10-1/2" Rear Axle
- Same as Ford Part Number 205-448
- Use with a 1/2" Drive Ratchet or Breaker Bar



## 1/2" Drive Socket Bearing Locknut

SKU 231203 **17<sup>99</sup>**  
25243

- Fits Adjusting Nuts Found on Ford F150 Trucks (1995 to 1996) and Full Sized Broncos with Automatic Locking Hubs



## 4WD Ford Spindle Socket, 66.5 mm x 80 mm

SKU 603346 **19<sup>99</sup>**  
25965

- Fits Ford F-Series 1/2-Ton Truck and Full-Size Bronco with Manual Hubs; 1995-Newer Ford F-Series 3/4-Ton and 1-Ton Trucks with Manual Hubs; 1959-85 Ford F-Series 1/2- and 3/4-Ton Trucks and Full-Size Bronco; 1960-90 GM 1/2-Ton Truck and Full-Size Blazer/Jimmy; 1969-89 Dodge 1/2-Ton Truck with Manual Hubs; 1969-72 International 1/2-Ton Truck
- 1/2" Sq. Drive



## 4WD Ford - Dodge Spindle Socket, 76 mm x 80 mm

SKU 603347 **21<sup>99</sup>**  
25966

## Toyota 8 Pin Front Hub Locknut Socket

SKU 298205 **34<sup>99</sup>**  
25962

- Allows for Easy Removal and Installation of Front Hub Lock Nut without Damage to the Nut
- Applications: Toyota 4Runner 2WD (2007 to 2014), Toyota Sequoia (2008 to 2014), Toyota Tundra (2007 to 2014)
- 3/4" Drive



**NEW**

## HIGH-POWERED, RECHARGEABLE WORK LIGHTS

**OEM TOOLS**

### Portable Dual Mode LED Work Lights with Multi-Position Mounting

- Dual Mode Features a Flood LED Work Light and a Directional Flashlight
- 180° Magnetic Adjustable Base
- USB-C Rechargeable

**200 Max. Lumens**  
SKU 1525563  
32132 **34<sup>99</sup>**

- Heavy-Duty Belt Clip
- Charging Time: 2.5 Hours



**LUMENS**

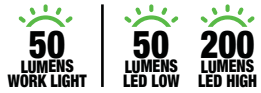

**RUNTIMES**



**400 Max. Lumens**  
SKU 1525555  
32124 **39<sup>99</sup>**

- 360° Rotating Hanging Hook
- Charging Time: 2.5 Hours



**LUMENS**



**RUNTIMES**



**600 Max. Lumens**  
SKU 1525559  
32126 **44<sup>99</sup>**

- 360° Rotating Hanging Hook
- Charging Time: 3.5 Hours



**LUMENS**



**RUNTIMES**



Adjustable Base

### 2 Pack Button LED Lights

SKU 1525557  
32129 **24<sup>99</sup>**

- Magnetic Base for Hands-Free Use
- Charging Time: 0.5 Hours
- Includes: Two LED Lights with Two Charging Ports, USB-C and Micro USB, and 1 Charging Cable



**LUMENS**

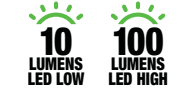

**RUNTIMES**



### Mini Rechargeable LED Light

SKU 1525564  
32137 **19<sup>99</sup>**

- Dual Mounting Options; Heavy-Duty Clip and Dual Magnets
- Charging Time: 2.5 Hours



**LUMENS**



**RUNTIMES**



Heavy-Duty Clip

### LED Light with Auto Sensor

SKU 1525569  
32122 **39<sup>99</sup>**

- Auto Sensor Automatically Turns Light Off When Sensor is Covered
- Dual Mounting Options; Heavy-Duty Clip and Dual Magnets
- Charging Time: 3.5 Hours



AUTO ON/OFF

**LUMENS**

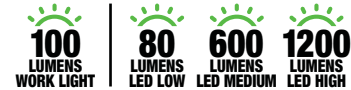

**RUNTIMES**



LIGHTWEIGHT  
5.2 oz.

## Flashlights

**OEM TOOLS**

### Rechargeable Multi-Head All-in-One Work Light Kit

SKU 765525  
24648 **89<sup>99</sup>**

- Quick-Attachment Coupler Allows for Easy Accessory Transition Between 3 Interchangeable Heads
- Comes with USB Charging Cord, AC Adapter, 180° Swivel Hook and (1) 18650 Rechargeable Battery



### Work Lamp Attachment for 24648 Work Light Set

SKU 884377  
24648E **14<sup>99</sup>**

### Magnetic Rechargeable LED Work Light

SKU 819644  
25982 **49<sup>99</sup>**

- 3W COB LED, Super Bright White Lights: 400 Lumens
- 3.7V 2200 mAh Li-ion Battery
- Runtime: 3 Hrs. (Work Light), 9 Hrs. (Torch Light)
- Powerful Magnets on the Back and Swivel Base
- Includes: USB Cable for Recharging



MAX OUTPUT  
400  
LUMENS

9.0 hrs  
MAX RUNTIME



Swivels, Hangs,  
or Sticks



**GreatLite**

### E36 Cree Rechargeable Flashlight Kit

SKU 568461  
EXPE36-E02 **59<sup>99</sup>**

- Beam Distance: 300 Meters
- Impact Resistant Up to 1.5 Meters
- IPX-6 Water Resistant
- Includes: (1) 18650 Battery and Charger

1000  
LUMENS

2.0 hrs  
RUN TIME



# LIGHTING

## Work Lights

Multi-Application Work Lights Deliver Functionality of Several Lights in Just One Versatile Light

5 Light Modes  
High  
Medium  
Low  
Strobe  
SOS

**330 Lumens**  
SKU 105560  
24605 **44<sup>99</sup>**

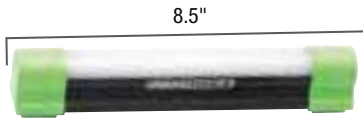

**600 Lumens**  
SKU 822266  
25997 **54<sup>99</sup>**



**1000 Lumens**  
SKU 850228  
24604 **99<sup>99</sup>**



**360 Lumens**  
SKU 603726  
24695 **29<sup>99</sup>**

• 3.5 Hr. Runtime on High



**STORE STOCKED**

## Inspection Lights

**Mechanics 500 Lumen Rechargeable Flashlight and 450 Lumen Ultra Slim Wand with UV Inspection**

SKU 344835  
24607 **59<sup>99</sup>**

- 5 Light Modes: 100%, 50%, 25%, Strobe and SOS
- Flashlight Head Can Be Removed and Replaced with the Slim Inspection Light (as Shown)
- 3 Powerful, UV LED Lights on Inspection Light Detect Leaks Quickly and Easily

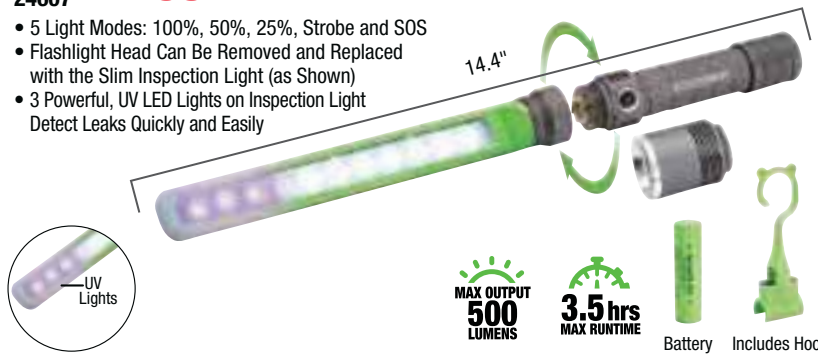

Detachable 180° Swivel Hook



USB Rechargeable



MAX OUTPUT  
**500**  
LUMENS

MAX RUNTIME  
**3.5 hrs**

Battery Includes Hook

**Pivoting Ultra-Slim 300 Lumen Work Light**

SKU 603727  
24696 **27<sup>22</sup>**

- Ultra-Slim Body Design Pivots 180° Providing More Light to Any Work Area
- Magnetic Base Attaches to Any Ferrous Surface
- 4 Light Modes: High, Low, Top Light and Handle Spotlight
- Top Light Illuminates the Tightest Work Areas

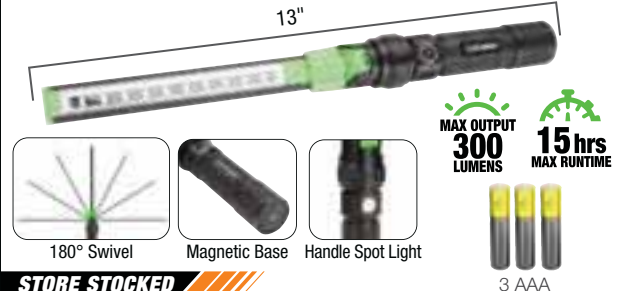

MAX OUTPUT  
**300**  
LUMENS

MAX RUNTIME  
**15 hrs**

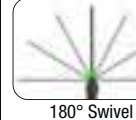

180° Swivel

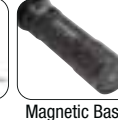

Magnetic Base



Handle Spot Light



3 AAA

**STORE STOCKED**

**700 Lumen Rechargeable COB LED Slim Inspection Light**

SKU 418752  
24646 **19<sup>99</sup>** REG. \$29.99

**SAVE \$10**

- Unique Variable Dial Lets You Control Output (0 to 700 Lumens)
- Runtime: 10 Hours (at 50% Power), 2.5 Hours (at 100% Power)
- Removable Magnetic Base with 360° Swivel and Lock Feature Lets You Adjust Angle to Point Light Where it's Needed



Offer Good Through  
June 30, 2025

MAX OUTPUT  
**700**  
LUMENS

MAX RUNTIME  
**10 hrs**

**Periscope LED Flashlight**

SKU 526504  
25458 **25<sup>99</sup>**

- Chip On-Board LED
- Beam Distance: 2 Meters
- IPX-4 Water Resistant
- Includes: Magnetic Base to Stand Upright and 2 AA Duracell Batteries



2 AA

**2-in-1 Rechargeable Pocket Light**

SKU 081751  
26029 **19<sup>99</sup>**

- Super Bright COB LED Work Light with Integrated LED Flashlight
- Easy Hands-Free Operation with Magnetic Base and Magnetic Pocket Clip
- Max. Output (Work Light): 200 Lumens
- Max. Output (Flashlight): 140 Lumens
- Max. Runtime: 3 Hrs.



120° Rotating  
Magnetic Clip

MAX OUTPUT  
**200**  
LUMENS

MAX RUNTIME  
**3.0 hrs**

**Tire Kicker with Flashlight**

SKU OUTSIDE BUY/EPO  
74217 **39<sup>99</sup>**



- Water Resistant
- 130 Meter Beam Distance
- Length: 16.25"
- Diameter: 1.25"



For Outside Buy/EPO, Call 901-300-4878



MAX OUTPUT  
**150**  
LUMENS

MAX RUNTIME  
**30 hrs**

**3-in-1 Multi-Use Rechargeable Diagnostic Under-the-Hood Work Light**

SKU 591153  
24609 **79<sup>99</sup>**

- 5.5 Hr. Runtime on High



MAX OUTPUT  
**400**  
LUMENS

MAX RUNTIME  
**5.5 hrs**

UV Leak Dye Detection Light



400 Lumens Super Bright Work Light



Yellow Smoke Detection Light





# LIGHTING

TO ORDER, contact your Commercial Sales Manager or go to [AutoZonePro.com](http://AutoZonePro.com)

LIGHTING

## Underhood Lights

### 1,500 Lumen LED

SKU 1414960  
ATD80050A **154<sup>99</sup>**

- 25 Ft. Cord Remains Flexible in Extreme Cold
- Rubber Covered Telescoping Brackets For Use on Hoods from 47" to 75" Wide



### 2,000 Lumen LED Corded/Cordless

SKU 1414959  
ATD80357 **199<sup>99</sup>**

- 40" Light Bar Provides 2000 Lumens of Bright Light
- Hooks Extend 55" to 83" to Fit New SUVs and Light Trucks
- 25' Removable Cord Remains Flexible in Cold Weather
- 2 Modes: High-2000 Lumens/Low-1000 Lumens
- 5200 mAh Li-ion Battery Provides Up to 2 Hours (High), Up to 4 Hours (Low) Runtime



## Cord Reel

### 50' Retractable Extension Cord Reel

SKU 1105991  
LEGFZ8140503 **199<sup>99</sup>**

- Circuit Breaker with Reset Button Prevents Breaker Trip or Blown Fuses
- Oil-Resistant 14/3 AWG SJTOW Cord
- Lighted Triple Tap Outlet



## Streamlights

### Stinger LED with AC/DC

SKU 291368  
STL75732 **249<sup>99</sup>**

- 425 Lumens
- Runtime: 10 Hours
- Beam Distance: 322 Meters
- Four Lighting Modes: High, Medium, Low and Strobe



### Stylus Pro with White LED



- 48 Lumens
- Runtime: 7.5 Hours
- Waterproof Construction with an Unbreakable Polycarbonate Lens Pocket Clip

#### Blue

SKU 291362  
STL66122 **36<sup>99</sup>**

#### Red

SKU 291358  
STL66120 **36<sup>99</sup>**

#### Black

SKU 291408  
STL66118 **36<sup>99</sup>**

#### Silver

SKU 291359  
STL66121 **36<sup>99</sup>**



## Pen Lights

### Cree LED Pen Light

- 3 Modes: Low (50 Lumens), High (150 Lumens) and Strobe
- 80 Meter Beam Distance
- Anodized Aluminum Body is Impact and Water Resistant
- Battery Runtime: 6 Hours (Low), 3 Hours (High)
- Comes with 2 AAA Batteries and Tactical Clip

MAX OUTPUT  
**150 LUMENS**  
MAX RUNTIME  
**6.0 hrs**

#### Red

SKU 592188  
32838

#### Silver

SKU 592183  
32839

#### Black

SKU 592184  
32835

#### Blue

SKU 592185  
32836

**19<sup>99</sup>** each



2 AAA

# SYLVANIA

#1 AFTERMARKET AUTOMOTIVE LIGHTING BRAND IN THE USA<sup>1</sup>

<sup>1</sup>Circana/U.S. Retail Tracking Service, March 2, 2024  
<sup>2</sup>See packaging for details <sup>3</sup>Compared to SYLVANIA BASIC

LED OFF ROAD LIGHTBARS + PODS



## SYLVANIA LED OFF ROAD LIGHTS



### LIFETIME LIMITED WARRANTY<sup>2</sup>

Superior optical engineering  
Durable design  
Water resistant (IP67 or IP69K)

UPGRADE YOUR HEADLIGHTS

### SYLVANIA LED



#### 5 YEAR LIMITED WARRANTY<sup>2</sup>

Performance, Longevity + Style

PART NUMBERS:  
9003 | 9005 | 9006 | 9007 |  
9012 | H1 | H7 | H8 | H9 |  
H11 | H13 | H16

For powersports or fog use only.

### SILVERSTAR ULTRA



#### FARTHEST DOWNROAD + WHITER LIGHT<sup>3</sup>



MORE CLARITY<sup>3</sup> FOR ULTRA NIGHT VISION

### SILVERSTAR



#### FARTHER DOWNROAD + WHITER LIGHT<sup>3</sup>

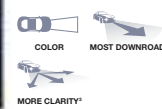

MORE CLARITY<sup>3</sup>

### XTRAVISION



#### FARTHEST DOWNROAD<sup>3</sup>



MORE DOWNROAD<sup>3</sup>

EXPERIENCE THE DIFFERENCE OF

# LED



## NEW! SYLVANIA LED SEALED BEAM LAMPS

5 Year Limited Warranty<sup>2</sup>  
Direct replacement  
DOT compliant  
Engineered with OEM grade OSRAM LEDs

Available Part Numbers: H6024 | H6054  
Additional part numbers coming soon



HALOGEN  
SYLVANIA BASIC



LED  
SYLVANIA LED

Prices subject to change without notice. Prices do not include applicable taxes, vehicles, tires, rims, installation or optional equipment as shown. Please do not return purchases to the store. For information regarding warranty, repair, or any questions or concerns, call 901-300-4878.

AZG0225

65

# BATTERY SERVICE

## Battery Testers

**OEM TOOLS**

### Professional Series Battery Tester

SKU 750009 **19<sup>99</sup>**  
24508

- Large Tester Uses Gravity with the Number of Floating Discs to Show State of Battery Charge
- Specific Gravity Levels are Printed on the Tough, See-Through Plastic Body
- Large 16-1/4" Disc-Type Tester is Accurate Down to -40°F



### Digital Battery Analyzer

SKU 819073 **39<sup>99</sup>**  
24359

- Shows Available Power in CCA Starter and Charging System Testing
- Easy-to-Read Backlit LCD Screen
- Voltage Range: 1.5-15VDC
- Battery CCA: 200-1200



**STORE STOCKED**

### 100 Amp Battery Load Tester

SKU 203583 **32<sup>99</sup>**  
24338

- Conveniently Tests Batteries in Just 10 Seconds
- Battery Load Test: 100A (12V), 50A (6V)
- Designed to Work on Both 6V and 12V Batteries Up to 1,000 CCA
- Determines State of Charge, Cranking and Charging Volts
- Convenient Handle for Transport



### 500 Amp Carbon Pile Load Tester

SKU 1168827 **79<sup>99</sup>**  
24336

- Variable Load Capability to 500 Amps
- Tests Batteries to 1,000 CCA
- Test Alternators, Regulators and Starters
- Large, Easy-to-Read Gauges
- Heavy Duty Clamps



### Battery Conductance Tester

**MIDTRONICS** Advancing Battery Management

SKU 291330 **239<sup>99</sup>**  
MIDPBT100

- Tests Both the Starter and the Charging System
- Tests 12V Automotive Batteries from 200 to 850 CCAs
- Durable Design for the Workshop or in the Field



### BT MobilePro S Jump Start/Power Bank/BSC System Analyzer

SKU 1485041 **124<sup>99</sup>**  
TPDBTMPROS

- Turns Your Diagnostic Scan Tool into a Battery Tester
- Compatible to Phoenix Line of Diagnostic Scanners
- Battery, Cranking and Charging Tests
- Tablet Compatibility
- Test Voltage: 12V
- Test Range: 100~2000CCA
- Battery Type: Regular Flooded, AGM, EFB and GEL
- Test Standards: CCA, BCI, CA, MCA, JIS, DIN and More



### BT600 Battery Tester with Printer

SKU 1339732 **139<sup>99</sup>**  
TPDBT600

- 3.5" Color Screen
- Built-In Thermal Printer
- Performs Complete Battery, Cranking and Charging Tests
- Large, Reinforced, Smoke-Free and Spark-Free Copper Clamps
- Quick and Accurate Test Results



### Thermal Printer Paper for BT600, BT300P

SKU 1442591 **34<sup>99</sup>**  
TPDBTPAPER

### 12V Digital Battery Electrical System Tester with Printer

SKU 343373 **469<sup>99</sup>**  
ASC12-1015

- Tests Both Batteries Up to 1,700 CCA and Alternators
- Tests Starters and Charging Systems
- Backlit Digital Display
- 9 Languages
- Includes: Deluxe Case and Extra Print Paper



### 12/24V Digital Battery Electrical System Tester with Printer

SKU 1491305 **529<sup>99</sup>**  
ASC12-2415

- Tests Both Batteries Up to 2,000 CCA and Alternators

## Battery Service Tools

### Side Terminal Battery Wrench

- For Use with Side Terminal Batteries Found on Many GM and Other Domestic Vehicles



5/16" SKU 466513 **9<sup>99</sup>**  
25287

- Length: 5-1/2"

10 mm and 5/16" SKU 965838 **14<sup>99</sup>**  
25282

- Length: 12"

### 2 Liter Battery Filler

SKU 972771 **19<sup>99</sup>**  
87010

- Automatic Shut-Off to Prevent Overfilling
- Fills Battery to Proper Level without Spilling



### Battery Terminal Puller

SKU 466489 **10<sup>99</sup>**  
25121

- Use to Remove Battery Terminal Clamp without Damaging the Battery Post
- Puller Will Also Work on Corroded Spring-Type Clamps



### Battery Nut Pliers

SKU 943134 **19<sup>99</sup>**  
25123

- Easily Tighten and Loosen Nuts
- Offset Handles
- Serrated Jaws for a Firm Grip



### Battery Carrier

SKU 002284 **18<sup>99</sup>**  
25316

- Designed to Grab, Lift and Carry Top Post and Side Terminal Batteries
- Grips Battery Widths from 5" to 7" with Rubber Pads
- Plastic Hand Grip Provides a Firm Hold



### 6 Piece Battery Service Kit

SKU 1168822 **69<sup>99</sup>**  
25110

- Includes: Battery Terminal Puller, 4-Way Post Cleaner, Battery Nut Pliers, Extended 5/16" and 10 mm Battery Terminal Wrench, 5/16" Side Terminal Battery Wrench and a Side Terminal Brush Organized in a Heavy Duty, Roll-Up Storage Sleeve



# BATTERY SERVICE

TO ORDER, contact your Commercial Sales Manager or go to [AutoZonePro.com](http://AutoZonePro.com)

BATTERY SERVICE

## Jump Starters

TOPDON®

### Battery Tester and Jump Start

SKU 1368635  
TPDV2200PLUS **119<sup>99</sup>**

- Jump Start Capacity: 8L Gas, 6L Diesel
- 2200A Peak Current for Jumps
- Use the App to Perform Detailed Battery Tests
- 300 Lumen LED Light with Solid, SOS and Strobe Functions
- Output Ports: Type-C: USB1, USB2, DC



### JumpSurge 3000 Amp Portable Jump Starter

TOPDON®

SKU OUTSIDE BUY/EPO  
TPDJS3000 **169<sup>99</sup>**

Sturdy Outer Housing Resistant to Water, Dust and Wear

- 45 Jumps on a Single Charge
- USB Quick Charge 3.0 Port
- Heavy Duty Smart Clamps



### Kwikstart® 12 Volt Portable Power and Jump Start

ASSOCIATED

SKU 850637  
ASC6256 **264<sup>99</sup>**

- Peak Amp Output: 1700 Amps
- 360 CCA of Boost Assist
- (2) 12V DC Accessory Outlets to Power and/or Recharge DC Electronics
- 32" Heavy Duty Cables and USB Port



### 30,000 mAh Lithium Jump Starter for V10 and Diesel

SKU 1268417  
CAL590 **249<sup>99</sup>**



New Improved Design

- Vehicle Jump Starter and Backup Charger for Portable Electronics
- 800 Cranking Amps and 1800 Peak Amps
- 30,000 mAh High Capacity Li-ion Battery
- Fast Charging with Low Self-Discharge Cycle
- Includes: Intelli-Clamps for Jumpstarting with Built-In Safety and Diagnostic Features



### Premium 1700 Peak Amp 12 Volt Jump Starter

SOLAR

SKU OUTSIDE BUY/EPO  
SOLJNC770R **324<sup>99</sup>**

- Heavy Duty Clamps with 68" Cables
- 1700 Peak Amps; 425 Cranking Amps
- Dual USB Outlets to Charge Mobile Devices
- Master ON/OFF Switch



### 1700 Peak Amp 12 Volt Jump Starter

SKU OUTSIDE BUY/EPO  
SOLJNC660 **299<sup>99</sup>**

- Heavy Duty Clamps with 46" #2 AWG Welding Cables.
- 1700 Peak Amps; 425 Cranking Amps
- Heavy Duty Clamps with 46" Cables

### 3400 Amp 12/24 Volt Jump Starter

SOLAR

SKU OUTSIDE BUY/EPO  
SOLJNC1224 **649<sup>99</sup>**

- Voltmeter Provides Charge Status of Onboard Battery
- Clore PROFORMER Battery Technology
- 3400 Peak Amps and 850 Cranking Amps - 12V
- 1700 Peak Amps and 425 Cranking Amps - 24V



### 2-in-1 2200 Peak Amp Jump Starter and Tire Inflator

SKU 1485043  
TPDV2200AIR **129<sup>99</sup>**

- Battery Capacity: 12000mah
- Delivers a Powerful 2200A Peak Current with Up to 25 Starts Per Charge
- Capable of Jump-Starting Vehicles with Engines Up to 8.0 Liters for Gasoline or 6.0 Liters for Diesel
- Functions as a PD45W Fast-Charging Power Bank
- 400-Lumen LED Flashlight
- Tire Inflator Fills in Under 3 Minutes



TOPDON®

### 2-in-1 4500 Peak Amp Jump Starter and Battery/System Tester

SKU 1485040  
TPDV4500PLUS **229<sup>99</sup>**

- Up to 45 Jump Starts on a Single Charge
- Test and Monitor Battery with App
- Peak Amps: 4500
- 500 Lumen Flashlight
- Outputs: Bidirectional TYPE-C, USB1, USB2
- IP65-Rated Casing
- Includes: D45W Charger Adapter, DC Adapter, DC Adapter and PD100W Cable



TOPDON®

To Confirm Price, Availability and Ordering Instructions on Outside Buy/EPO Call 901-300-4878

## Wheeled Chargers

SOLAR

### Battery Charger 12V

SKU OUTSIDE BUY/EPO  
SOL4735 **289<sup>99</sup>**

- EZ View Control Panel
- 200 Amp Engine Starting Assistance
- 40 Amp Fast Charge Rate
- 5 Amp Setting for ATVs, Boats, Lawn and Garden Applications



### Battery Charger with Engine Start 12/24V

SKU OUTSIDE BUY/EPO  
SOL4745 **354<sup>99</sup>**

- 40 Amp 12V, 20 Amp 24V Charge Rate

SOL4735

## Smart Charger

### 30A Smart Charger and Power Supply

SKU 1442582  
TPDT30000 **299<sup>99</sup>**

- Suitable for Multiple Battery Types, Including AGM, LI, WET, GEL, MF CAL and EFB
- 9-Step Smart Charging, Checks for Sulphation and Acid Stratification, Repairs Batteries, Prevents Battery Damage
- Works as a Stable Power Supply for 12V and 24V Devices
- Current Range: 12V-30A, 24V-15A, 6V-15A, 12V-10A
- Clamp Cable Length and Gauge: 7.2', AWG10



TOPDON®

One Charger Does It All



Prices subject to change without notice. Prices do not include applicable taxes, vehicles, tires, rims, installation or optional equipment as shown. Please do not return purchases to the store. For information regarding warranty, repair, or any questions or concerns, call 901-300-4878.

AZG0225

67

# BATTERY SERVICE

## Associated Battery Chargers

**ASSOCIATED**



Safe In Any Weather



Made in USA



ASC6002B

ASC6021AGM

ASC6012AGM

ASCESS6008MSK

ASCESS6007B

ASCI6008MSK

	Commercial Duty Charger SKU 221248 ASC6002B	Heavy Duty Fleet Charger/Analyzer SKU 1414394 ASC6021AGM	Heavy Duty Charger SKU 662763 ASC6012AGM	Intellamatic® Charger and Re-flash Power Supply			
				SKU 344790 ASCESS6008 (Not Pictured)	SKU 343379 ASCESS6008MSK	SKU 343370 ASCESS6007B	SKU 662745 ASCI6008MSK
Charger Type	Wheel	Wheel	Wheel	Wheel	Wheel	Wheel	Wheel
UL of CSA Continuous Amperage Charging Rate	100/80A	70/65/30A	70/60A	60A	60A	40A	60A
Re-Flash Power Supply Output Amperage	N/A	N/A	N/A	70A @ 13.9V	70A @ 13.9V	45A @ 13.9V	70A @ 13.9V
Crank Assist Amperage	400	205A	250	270	270	130	270
Operating Charging Voltage	6/12/18/24V	6/12/24V	6/12V	12V	12V	12V	12V
Battery Types	SLA	SLA, AGM, EFB	SLA, AGM, EFB	SLA, AGM, Gel-Cell, EFB	SLA, AGM, Gel-Cell, EFB	SLA, AGM, Gel-Cell, EFB	SLA, AGM, EFB, Li-ion, Gel-Cell
Smart Charger	N	N	N	Y	Y	Y	Y
Adjustable Charging Voltage	N	N	N	N	N	N	Y
Adjustable Re-Flash Power Supply Voltage	N	N	N	Y	Y	Y	Y
Memory Saver Mode	N	N	N	N	Y	N	Y
DC Cable Length and Gauge	8' 4AWG	6.5' 4AWG	6.5' 6AWG	6.5' 6AWG	6.5' 6AWG	6.5' 6AWG	6.5' 6AWG
Warranty*	2 Year B2B 5 Year Limited	2 Year B2B 5 Year Limited	2 Year B2B 5 Year Limited	2 Year B2B 3 Year Limited	2 Year B2B 3 Year Limited	2 Year B2B 3 Year Limited	2 Year B2B 3 Year Limited
<b>Price</b>	<b>1,224<sup>99</sup></b>	<b>874<sup>99</sup></b>	<b>679<sup>99</sup></b>	<b>979<sup>99</sup></b>	<b>1,114<sup>99</sup></b>	<b>784<sup>99</sup></b>	<b>1,379<sup>99</sup></b>

\*Two years bumper to bumper (B2B) manufacturer's warranty with five years transformer/rectifier for heavy duty battery chargers (6001A, 6002B, 6006, 6009 and 6012) and three years transformer/rectifier warranty for INTELLAMATIC wheeled smart chargers.

### Power Supply

**ASSOCIATED**

#### 12V - 90A Re-flash Power Supply and Charger

SKU OUTSIDE BUY/EPO  
ASCESS6100 **1,614<sup>99</sup>**

- Adjustable Power Supply from 12.6V to 14.9V at up to 90 Amps
- Safe for All Batteries Including AGM, EFB, Li-ion and Gel
- OEM Vehicle Manufacture Approved
- 8.4 Ft. DC Leads



For Outside Buy/EPO, Call 901-300-4878

#### Smart Battery Charger/Power Supply

SKU 1414398  
TPDT90000 **699<sup>99</sup>**

- ECU Programming Power Supply
- 9 Step Smart Charging with Thermal Compensation
- Charges 12V and 24V AGM, WET, GEL, MF, CAL and EFB Batteries
- Protects Against Reverse Polarities, Reverse Charges, Short Circuits, Overheating and Over-Voltages
- Current Range: 5-90 and 5-45A
- Voltage Range: 11-15.8V and 22-31.5V
- Cables: AWG18-70"

**BONUS VALUE: \$99.99**

#### Tornado90000 9.5' DC Cable Extension

TPDT90DC With Purchase of: TPDT90000

Offer Good While Supplies Last Through June 30, 2025



#### TOPDON®

#### 120A Power Supply and Battery Charger

SKU 1485033  
TPDT1200005 **899<sup>99</sup>**

- Intelligent Current (5-120A) and Voltage (11-16.8V) Output Adjustment
- 3 Major Charging Modes and 9-Step Smart Charging
- Compatible with Lead-Acid Batteries and Lithium Batteries
- Clamp Cable Length: 16 Ft.



# BATTERY SERVICE

TO ORDER, contact your Commercial Sales Manager or go to [AutoZonePro.com](http://AutoZonePro.com)

BATTERY SERVICE

## Booster Cables

### 20 Ft. 4 Gauge Booster Cables with Storage Bag

SKU 1168815 **29<sup>99</sup>** REG. \$39.99  
24335

- Extra Long 20 Foot Flexible Cables Expands Your Reach
- Tangle Free Design Ensures Quick and Easy Connections
- Insulated Clamps Fit Top and Side Post Batteries
- Oil, Gas and Acid Resistant All Copper Wire
- Includes: Storage Bag



**SAVE \$10**

OEM TOOLS

### 20 Ft. Extra Flexible Cables



Offer Good Through June 30, 2025

## 6/12 Volt Charger

### 6/12V, 40A Standard Duty Wheel Charger

SKU 344795 **429<sup>99</sup>**  
ASCUS20

- 40 Amp Charger with 90 Minute Timer
- 40 Amp Continuous Rating at 6/12 Volts
- 200 Amp Cranking Assist and 330 Amps Boost
- Fan Cooling Prevents Overheating
- UL Listed
- Two Year Manufacturer's Warranty



## Bench Chargers

### 6/12V, 1A Maintainer

SKU 765478 **69<sup>99</sup>**  
ASC9003A

- LED Lights Indicating Charging Status
- Includes 2 Sets of Charging Leads
- OEM Vehicle Manufacture Approved
- Safe for AGM, Gel Cell, SLA Batteries
- Reverse Polarity Protected
- Overcharge Protection
- 1 Year Warranty



### 6/12V, 15/2A Smart Bench Top Charger

SKU 850634 **199<sup>99</sup>**  
ASC3100A

- Digital Display Shows Charging Voltage/Amperage or Time Remaining
- Safe for AGM, Gel Cell, SLA Batteries
- 100A Boost
- 1 Year Warranty



ASSOCIATED

## AUTEL MAXIBAS BATTERY & ELECTRICAL ANALYSIS

### MaxiBAS® BT609

SKU 1125832 **\$795<sup>00</sup>**  
Part #BT609

- Adaptive Conductance Technology: Produces a More Accurate Exam of the Battery's Status
- All System Scan, Read and Clear Codes
- Complete Service Menu 20+ Functions



### MaxiBAS® BT608

SKU 1105501 **\$595<sup>00</sup>**  
Part #BT608

- Adaptive Conductance Technology: Detects Battery Capacity Reducing Misdiagnosis
- Auto Battery Reset / Print Test Reports Via Built-in Thermal Printer
- AutoSCAN/VINScan for Quick Vehicle Identification & Battery Specifications



### MaxiBAS® BT506

SKU 1125835 **\$195<sup>00</sup>**  
Part #BT506

- Use with Smartphone or other Smart Device
- Support In-vehicle and Out-of-Vehicle Testing of Passenger Vehicle Batteries
- Test 6- and 12-volt Batteries: 100 - 2000 CCA
- Test 12- and 24- Cranking/Charging Systems
- Test Flooded, AGM, AGM Spiral, EFB & GEL Batteries



### OBDDII EXTENSION CABLE

SKU 1443473 **\$20<sup>00</sup>**  
Part #VICIEXTCAB

- Compatible with all OBDDII-compliant VCI's
- It keeps VCI in sight and is easy to retrieve and not forget after use



### MaxiBAS® BTAK

SKU 1149588 **\$245<sup>00</sup>**  
Part #BTAK

- Battery Tester Accessory Kit
- Digital Multimeter and Current Clamp Kit
- Measures Voltage, Current and Resistance



### MaxiBAS® BTMS

SKU 1149587 **\$45<sup>00</sup>**  
Part #BTMS

- Battery Tester Memory Saver
- Preserves Vehicle Codes and Electronic Presets When Replacing Battery
- Enables Vehicle Computer to Be Powered and Maintain Data When Connected to Backup Vehicle Battery



## AUTEL MAXIEV ADVANCED EV DIAGNOSTICS

NEW EV RELEASE



### MaxiEV® ALT100L

SKU 1442217 **\$3,200<sup>00</sup>**  
Part #ALT100L

- Tests high voltage battery enclosures and high voltage thermodynamics systems such as coolant and A/C for leaks
- High-sensitive pressure sensing significantly improves test accuracy and stability
- Dual Pressure Display: Real-time display of current pressure and leakage fluctuations



### MaxiEV® CDT100

SKU 1443474 **\$7,999<sup>00</sup>**  
Part #CDT100

- Wide-voltage design, suitable for discharge, charge, and activation testing of modules with different voltage levels
- Set constant current and power, Charge and Discharge modes for varied applications
- Displays single-cell maximum/minimum voltage and other data onscreen in graphs, columns, and report forms



### MaxiEV® ITS100

SKU 1442216 **\$580<sup>00</sup>**  
Part #ITS100

- Tests high voltage wiring and components
- Test resistance measurement before loading into the vehicle
- Helps identify issues like damage, deterioration, or contamination of the insulation

CALL YOUR COMMERCIAL SALES MANAGER FOR CURRENT DEALS & ORDERING

AUTEL

Prices subject to change without notice. Prices do not include applicable taxes, vehicles, tires, rims, installation or optional equipment as shown. Please do not return purchases to the store. For information regarding warranty, repair, or any questions or concerns, call 901-300-4878.

AZG0225

69

# AIR COMPRESSORS



Description and Part Number	<b>3.5 HP 60 Gallon 230V Air Compressor, Single Phase</b> SKU OSB/EPO ABA3-2160V1	<b>5 HP 60 Gallon 230V Air Compressor, Single Phase</b> SKU OSB/EPO ABA5-2160V4	<b>5 HP 80 Gallon 230V Air Compressor, Single Phase</b> SKU OSB/EPO ABA5-2180V4NS	<b>5 HP 80 Gallon 230V Air Compressor</b> SKU OSB/EPO ABAC5-2180V - Single Phase ABAC5-2380V - 3 Phase	<b>7.5 HP 80 Gallon 230V Air Compressor</b> SKU OSB/EPO ABAC7-2180V2 - Single Phase ABAC7-2380V2 - 3 Phase	<b>13 HP 30 Gallon Honda Powered Air Compressor</b> SKU OSB/EPO ABA13-30GH	<b>10 HP 120 Gallon 230V Air Compressor, 3 Phase</b> SKU OSB/EPO ABAC10-23120H
CARB Compliant	N/A	N/A	N/A	N/A	N/A	Yes	N/A
CFM at 100 psi	12.3 CFM (1 Technician)	15.4 CFM (1-2 Technicians)	15.4 CFM (1-3 Technicians)	18 CFM (2-3 Technicians)	27 CFM (2-4 Technicians)	23 CFM (1-3 Technicians)	35 CFM (3-6 Technicians)
Max. Pressure	135 psi	175 psi	175 psi	175 psi	175 psi	175 psi	175 psi
Heavy Duty, Low-RPM Cast Iron Pump	Cast Iron Cylinders	Cast Iron Cylinders	Cast Iron Cylinders	Yes	Yes	Cast Iron Cylinders	Yes
Magnetic Starter Mounted and Wired	Not Required	Not Required	Not Required	Yes	Yes	Recoil and Electric Start	Yes
High Flow Belt Guard	Yes	Yes	Yes	Yes	Yes	Yes	Yes
<b>Price</b>	<b>1,199<sup>99</sup></b>	<b>1,619<sup>99</sup></b>	<b>1,999<sup>99</sup></b>	<b>2,849<sup>99</sup></b>	<b>3,649<sup>99</sup></b>	<b>3,349<sup>99</sup></b>	<b>4,299<sup>99</sup></b>

## Premium Models



**7.5 HP 80 Gallon 230V**  
SKU OUTSIDE BUY/EPO  
ABAC7-2180V2FF

**4,349<sup>99</sup>**

- Vertical 80 Gallon Tank
- Horsepower: 7.5 HP
- Power Supply (V/Ph): 230V/1
- CFM @ Max. psi: 24
- Max. psi: 176



**10 HP 120 Gallon 230V**  
SKU OUTSIDE BUY/EPO  
ABAC10-23120VFF

**5,349<sup>99</sup>**

- Vertical 120 Gallon Tank
- Horsepower: 10 HP
- Power Supply (V/Ph): 230V/3
- CFM @ Max. psi: 32
- Max. psi: 176



Premium Models Include: Low Oil Level Shut Off, Auto Tank Drain and Belt Guard Aftercooler

## Rotary Screw Compressors

Rotary Screw Compressors are an Ideal Solution for Applications Where There is Continuous Demand for Dependable Compressed Air



- High Performance with Low Energy Consumption
- Low Noise and Vibration Levels
- Fully Integrated Aluminum Block

**10 HP 131 Gallon 150 psi Screw Compressor with Dryer**

SKU OUTSIDE BUY/EPO  
ABAAS-10503TMD

**8,499<sup>99</sup>**

- 208V-230V-460V/3PH
- 34.1 CFM

**15 HP 131 Gallon 150 psi Screw Compressor with Dryer**

SKU OUTSIDE BUY/EPO  
ABAAS-15503TMD

**11,549<sup>99</sup>**

- 208V-230V-460V/3PH
- 46.4 CFM

**7.5 HP 131 Gallon 150 psi Screw Compressor**

SKU OUTSIDE BUY/EPO  
ABAAS-75501TM

**6,849<sup>99</sup>**

- 230V/1PH
- 27.1 CFM

ABAAS-10503TMD



ABAAS-75501TM



Customer Responsible For Offloading, Liftgate Service Available.

For Outside Buy/EPO, Call 901-300-4878

- Free Delivery in 48 Continental United States
- Specifications Subject to Change without Notice or Liability
- Equipment Lead Times and Shipping May Vary
- Customers Responsible for Offloading Equipment Upon Arrival
- Leasing Terms Available, Ask Your AutoZone® Commercial Sales Manager.

# AIR COMPRESSORS

FOR HELP with Selection, Confirm Availability and Ordering Instructions, Call 901-300-4878

AIR COMPRESSORS

## Regulators/Filters/Drains

### 5 Stage Desiccant Filter/Dryer

SKU 543076  
ARRC7612XL **519<sup>99</sup>**

- Includes: Gauge, Shut-Off Valve and (1) 1/2 Gallon of Desiccant
- Lowers the Dew Point to -30°F



### 1/2" Electronic Drain

SKU 543065  
ARR5804 **89<sup>99</sup>**

- Automatically Drains Compressor Tanks, Receiver Tanks or Filters
- 110 Volt
- 6' Power Cord



### Regulator with Gauge (1/4")

SKU 543086  
ARRR262G **49<sup>99</sup>**

- Adjustment Range is 5 to 125 psig
- Rated for 25 SCFM



### Filter Regulator Lubricator (1/2")

SKU 543075  
ARRC33354 **259<sup>99</sup>**

- Cleans, Dries and Lubricates Air Supply
- Operating Pressure Range: 5 to 125 psi
- 40 Micron Element
- 142 CFM

Extend the Life of Your Air Tools!



### Filter/Regulator (1/2")

SKU 543071  
ARRB754G **99<sup>99</sup>**

- Operating Pressure Range 5 to 125 psi
- 40 Micron Element
- 3 Position Non-Rising Adjustment Knob



### Air Regulator with Gauge (1/2")

SKU 543091  
ARRR354G **74<sup>99</sup>**

- Adjustment Range is 5 to 125 psig
- Rated for 100 SCFM



NAME	SKU	PART #	PRICE
Replacement Desiccant Silica Gel, 1 Quart	OSB/EPO	ARR34189	<b>24.99</b>

NAME	SKU	PART #	PRICE
Regulator with Gauge (3/8")	543088	ARRR353G	<b>74.99</b>

## BelAire

### 5 HP 60 Gallon 230V Air Compressor, Single Phase

SKU OUTSIDE BUY/EPO  
IMC4916V

**1,619<sup>99</sup>**

- 15.4 CFM @ 100 psi
- 165 psi Max. Pressure
- Cast Iron Cylinders
- 2 Stage Pump
- No Start-Up Kit Required
- High Flow Belt Guard
- Warranty: 2 Year Factory



### 5 HP 80 Gallon 230V Air Compressor, Single Phase

SKU OUTSIDE BUY/EPO  
IMC418V

**2,849<sup>99</sup>**

- 18 CFM @ 100 psi
- 175 psi Max. Pressure
- Solid Cast Iron 2 Stage Pump
- Magnetic Starter Included
- Fully Enclosed Belt Guard
- Warranty: 2 Year Factory



## Champion®

- 100% Cast Iron Pump with Alloy Steel Reed Valves
- Warranty: 1 Year Unit Parts and Labor, 2 Years Pump Parts and Labor

### 5 HP 80 Gallon RV Series VRV5-8

SKU OUTSIDE BUY/EPO  
CHCRV215AS01

**2,949<sup>99</sup>**

- 230V/1ph
- 17.0 CFM @ 175 psi
- 3600 RPM Motor, No Starter Needed

### 5 HP 80 Gallon RV Series VRV5-8 with Starter

SKU OUTSIDE BUY/EPO  
CHCRV215AS07

**3,399<sup>99</sup>**

- 230V/1ph
- 16.5CFM @ 175 psi
- 1800 RPM Motor with Magnetic Starter



CHCRV215AS07

## Refrigerated Dryers

- Removes Condensate and Vapor So Dry Compressed Air is Produced in a Continuous, Cost-Efficient Way

### Cool 15 CFM

SKU OUTSIDE BUY/EPO  
ABAC00L15

**844<sup>99</sup>**

### Cool 25 CFM

SKU OUTSIDE BUY/EPO  
ABAC00L25

### Cool 25 CFM

SKU OUTSIDE BUY/EPO  
ABAC00L25

**1,049<sup>99</sup>**

### Cool 35 CFM

SKU OUTSIDE BUY/EPO  
ABAC00L35

**1,269<sup>99</sup>**



## Mi-T-M

### 30 Gallon Air Compressor/Generator

SKU OUTSIDE BUY/EPO  
MTMAG2SM1430ME

**3,099<sup>99</sup>**

- CFM @ 175 psi 15.7
- Max. AC Output: 4000 Watts
- Continuous with Compressor On Load 2300 Watts
- Continuous with Compressor Off Load 3500 Watts
- Receptacles 2 NEMA 5-20R, 1 NEMA L6-20R
- Displacement/Engine 420cc Mi-T-M OHV
- Compressor Two Stage, Cast Iron Pump



Customer Responsible For Offloading, Liftgate Service Available.

For Outside Buy/EPO, Call 901-300-4878

- Free Delivery in 48 Continental United States
- Specifications Subject to Change without Notice or Liability
- Equipment Lead Times and Shipping May Vary
- Customers Responsible for Offloading Equipment Upon Arrival
- Leasing Terms Available, Ask Your AutoZone® Commercial Sales Manager.

Prices subject to change without notice. Prices do not include applicable taxes, vehicles, tires, rims, installation or optional equipment as shown. Please do not return purchases to the store. For information regarding warranty, repair, or any questions or concerns, call 901-300-4878.

AZG0225

# AIR TOOLS

## 1/2" Impact Wrenches

### Heavy Duty 1/2" Composite Stubby Impact Wrench

SKU 087596  
24418 **159<sup>99</sup>**

- Torque: 900 Ft/Lb.
- Includes (7) 1/2" Short Impact Sockets Sizes: 13 mm to 19 mm
- Custom Cut EVA Foam Storage Tray
- CFM: 4.0



**EVA**  
FOAM TRAY



**OEM TOOLS**



WARRANTY: 1 Year

### 1/2" Extended Anvil Impact Wrench

SKU 1282755  
KNGNC-4265Q **279<sup>99</sup>**

- 1200 Ft/Lb. Reverse Torque
- 200 to 800 Ft/Lb. of Torque
- 8500 Free Speed RPM
- 85 dBA



WARRANTY: 3 Years

**M7**

### 1/2" Impact Wrench

SKU 592249  
KNGNC-4232Q **209<sup>99</sup>**

- Mighty Small, Mighty Powerful Air Impact Wrench
- Max. Reverse Torque: 700 Ft/Lb.
- 85 dBA Noise Level Exceeds OSHA Standards
- Ultra Lightweight at Less Than 3 Lb.
- Twin Hammer Mechanism



WARRANTY: 3 Years

**M7**

### 1/2" Impact Wrench

SKU 970487  
IRT231HA **234<sup>99</sup>**

- Torque: 590 Ft/Lb.
- Pressure-Fed Lubrication System
- In-Handle Exhaust Directs Away from User
- Industry Standard for 3 Decades
- Sound Pressure: 94 to 105 dBA



WARRANTY: 1 Year

**IR** Ingersoll Rand

### 1/2" Super Duty Air Impact Wrench with Extended Anvil

SKU 604744  
IRT231HA2 **264<sup>99</sup>**

- Max. Torque: 590 Ft/Lb.
- In-Handle Exhaust Directs Air Away from User
- Pressure-Fed Lubrication System



WARRANTY: 1 Year

**IR** Ingersoll Rand

### 1/2" Air Impact Wrench Classic

SKU 495316  
IRT231C **199<sup>99</sup>**

- Original Twin Hammer Impact
- Torque: 600 Ft/Lb.
- Pressure-Fed Lubrication
- Adjustable Power Regulator
- 1/2" Square Drive



WARRANTY: 1 Year

**IR** Ingersoll Rand

### 1/2" Quiet Impact Wrench

SKU 738489  
IRT2135QXPA **369<sup>99</sup>**

- Torque: 780 Ft/Lb.
- Light, Quiet and Powerful Impact
- Twin Hammer Mechanism
- Weighs Only 4 Lb.



WARRANTY: 1 Year

**IR** Ingersoll Rand

### 1/2" Titanium Air Impact Wrench

SKU 695134  
IRT2235TIMAX **519<sup>99</sup>**

- Torque: 1,350 Ft/Lb.
- Reverse Torque: 930 Ft/Lb.
- Twin Hammer Impact Mechanism
- Lightweight



WARRANTY: 1 Year

**IR** Ingersoll Rand

### 1/2" Titanium Air Impact Wrench with Extended Anvil

SKU 738490  
IRT2235TIMAX2 **499<sup>99</sup>**

- Torque: 1,350 Ft/Lb.
- Max. Reverse Torque: 930 Lb.
- 8,500 Free Speed RPM
- Titanium Hammercase



WARRANTY: 1 Year

**IR** Ingersoll Rand

## 3/8" Impact Wrenches

### 3/8" Titanium Impact Wrench

SKU 198065  
IRT2115TIMAX **329<sup>99</sup>**

- Torque: 300 Ft/Lb.
- Feather Touch Trigger and Patented Push Button Forward/Reverse



WARRANTY: 1 Year

**IR** Ingersoll Rand

### 3/8" Mini Air Impact Wrench

SKU 1125881  
KNGNC-3612Q **174<sup>99</sup>**

- Maximum Reverse Torque Can Reach Up to 350 Ft/Lb. in 5 Seconds
- Low Noise Sound Level 85 dBA



WARRANTY: 3 Years

**M7**

## 3/4" Impact Wrench

### 3/4" Quiet Air Impact Wrench

SKU 592242  
KNGNC-6236Q **319<sup>99</sup>**

- Power of a 3/4" Drive in a 1/2" Body
- 1200 Ft/Lb. Max Reverse Torque
- 83 dBA Noise Level Exceeds OSHA Standards
- Weighs 5.9 Lb.
- Twin Hammer Mechanism



WARRANTY: 3 Years

**M7**



# AIR TOOLS

TO ORDER, contact your Commercial Sales Manager or go to [AutoZonePro.com](http://AutoZonePro.com)

AIR TOOLS

## Air Sanders

### 2" Surface Prep Air Sander

SKU 094650 25778 **54<sup>99</sup>**

- Includes Quick Change "Twist Lock" Mandrel
- Free Speed: 20,000 RPM
- Average Air Consumption: 3.2 CFM
- Air Inlet Thread Size: 1/4" NPT

WARRANTY: 1 Year



### Heavy Duty Reciprocating Air Saw

SKU 802225 24409 **99<sup>99</sup>**

- Recommended Air Pressure: 90 psi
- Air Consumption: 1.7 CFM
- Strokes per Minute: 9,000 SPM
- Air Inlet Thread Size: 1/4" NPT
- Lightweight: 1.50 Lb. (0.70 kg)
- Length: 10.6" (270 mm)
- Exhaust: Front
- Enhanced Blade Guard Design and Trigger Safety Lock
- Includes: Reciprocating Air Saw, 2 Hex Key Wrenches, 2 Saw Blades and 2 Blade Guards

WARRANTY: 1 Year



### 6" Dual Action Sander

SKU 970475 IRTIR311A **109<sup>99</sup>**

- Dual Action Pad Motion Reduces Swirl
- Built-In Silencer for Quiet Operation

WARRANTY: 1 Year



### Straight Line Sander

SKU 970479 IRTIR315 **189<sup>99</sup>**

- Twin Piston Design for Smooth Operation
- 3,000 Strokes per Minute
- Quick-Action Paper Clamps

WARRANTY: 1 Year



### Heavy Duty Mini Surface Prep Kit

SKU 087620 24417 **79<sup>99</sup>**

- 2" and 3" Heavy Duty Mini Air Surface Prep Sander
- (1) 2" Backer Pad and (1) 3" Backer Pad
- (2) 2" and (2) 3" Medium Grit Surface Prep Discs
- (2) 2" and (2) 3" Coarse Surface Prep Discs
- (2) 2" and (2) 3" Sander Discs
- Blow Mold Case

WARRANTY: 1 Year



## 1/4" Die Grinders

Composite Body with Built-In Silencing to Reduce Noise Level

### Mini Air Die Grinder

SKU 751631 24404 **44<sup>99</sup>**

- Air Consumption: 2.4 CFM
- Free Speed: 25,000 RPM
- Recommended Air Pressure: 90 psi

WARRANTY: 1 Year



### 1/4" Air Die Grinder

SKU 802212 24406 **29<sup>99</sup>** REG. \$49.99 **SAVE \$20**

- Air Consumption: 3.4 CFM
- Free Speed: 22,000 RPM
- Recommended Air Pressure: 90 psi
- Exhaust: Rear 360°

WARRANTY: 1 Year

Offer Good Through June 30, 2025



### Extended Air Die Grinder

SKU 802216 24408 **89<sup>99</sup>**

- Air Consumption: 2.5 CFM
- Free Speed: 23,000 RPM
- Recommended Air Pressure: 90 psi

WARRANTY: 1 Year



(Color May Vary)

### Mini Air Die Grinder

SKU 802211 24405 **49<sup>99</sup>**

- Air Consumption: 3.4 CFM
- Free Speed: 25,000 RPM
- Recommended Air Pressure: 90 psi

WARRANTY: 1 Year



### Mini Angle Air Die Grinder

SKU 802214 24407 **74<sup>99</sup>**

- Air Consumption: 2.8 CFM
- Free Speed: 18,000 RPM
- Recommended Air Pressure: 90 psi
- Built-in Silencing to Reduce Noise Level

WARRANTY: 1 Year



### 1/4" Mini Angle Die Grinder and Surface Prep Kit

SKU 94648 25777 **159<sup>99</sup>**

- Air Consumption: 4 CFM
- Free Speed: 20,000 RPM
- Grinding and Cleaning All-in-One Kit
- Comes in a Heavy Duty Plastic Tray

WARRANTY: 1 Year



## 1" Impact Wrench

### 1" Impact Wrench with Extended Anvil

SKU 970474 IRTIR285B6 **899<sup>99</sup>**

- Reverse Torque: 1,770 Ft/Lb.
- 6" Anvil for Better Truck Wheel Nut Accessibility
- Hi-Efficiency Motor

WARRANTY: 1 Year



## Air Drill

### 3/8" Quiet Reversible Air Drill

SKU 1189089 KNGQE-833 **144<sup>99</sup>**

- Sound Level: 83 dBA
- Ergonomic Rubber Grip
- Variable Speed Trigger
- Aluminum Body
- Convenient Forward/Reverse Control Lever
- Free Speed: 1,800 RPM

WARRANTY: 3 Years



Prices subject to change without notice. Prices do not include applicable taxes, vehicles, tires, rims, installation or optional equipment as shown. Please do not return purchases to the store. For information regarding warranty, repair, or any questions or concerns, call 901-300-4878.

AZG0225

# AIR TOOLS

## 1/4" Air Ratchets

### 1/4" Super Duty Air Impact Ratchet

SKU 850508 **49<sup>99</sup>**  
24415

**Impact Mechanism Adds Power and Prevents Kickback**

- Max. Torque: 50 Ft/Lb.
- Free Speed: 700 RPM
- CFM: 3.1 @ 90 psi
- Length: 6.5"
- Sealed Head Ratchet Housing Prolongs Tool Life
- Compact and Lightweight
- Most Power-to-Weight Ratio
- Rear Air Exhaust: 360° Adjustable



Composite Body

WARRANTY: 1 Year



### 1/4" Drive Industrial Air Ratchet

SKU 466593 **59<sup>99</sup>**  
25763

- Max. Torque: 18 Ft/Lb.
- Free Speed: 240 RPM
- Average Air Consumption: 3.0 CFM
- Recommended Air Pressure: 90 psi



WARRANTY: 1 Year

OEM TOOLS®

## 3/8" Air Ratchets

### 3/8" Air Ratchet

SKU 970485 **154<sup>99</sup>**  
IRTIR107XPA

- Max. Torque: 54 Ft/Lb.
- Advanced Head Design
- 360° Adjustable Exhaust



WARRANTY: 1 Year

IR Ingersoll Rand

### 3/8" Air Ratchet Wrench

SKU 662908 **144<sup>99</sup>**  
KNGNE-343

- Max. Reverse Torque: 75 Ft/Lb.
- Forward Working Torque: 10 to 55 Ft/Lb.
- Free Speed: 160 RPM



WARRANTY: 3 Years

IR

### 3/8" Super Duty Air Impact Ratchet

SKU 850055 **99<sup>99</sup>**  
24416

- Max. Torque: 50 Ft/Lb.
- Free Speed: 700 RPM
- CFM: 3.1 @ 90 psi
- Length: 6.5"
- Sealed Head Ratchet Housing Prolongs Tool Life
- Compact and Lightweight
- Most Power-to-Weight Ratio
- Rear Air Exhaust

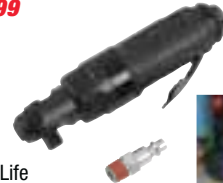

WARRANTY: 1 Year

OEM TOOLS®



## Air Hammers

### Standard Duty Air Hammer

SKU 1392327 **109<sup>99</sup>**  
IRT117

- 2,000 Blows per Minute
- Heat-Treated Piston and an Alloyed Steel Barrel



WARRANTY: 1 Year

### 121Q Super Duty Air Hammer

SKU 478945 **164<sup>99</sup>**  
IRT121Q

- Ideal for Body Panel Crimping and Cutting, Bushing Driving, Shearing and General Front End Work
- Built-In Power Regulator and Trigger Control
- Easy to Control with an "Easy Out" Throttle



WARRANTY: 1 Year

IR Ingersoll Rand

## Cut-Off Tools

### Air Reciprocating Saw

SKU 970481 **154<sup>99</sup>**  
IRTIR429

- Designed for Cutting Intricate Shapes
- Cuts Flat and Curved Surfaces
- Comes with 6 High Speed Steel Cutting Blades

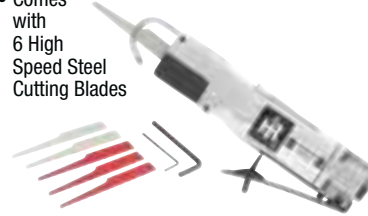

WARRANTY: 1 Year

IR Ingersoll Rand

### 3" Air Cut-Off Tool

SKU 466590 **29<sup>99</sup>** REG. \$39.99  
25760

- Air Inlet Thread Size: 1/4" NPT
- Free Speed: 22,000 RPM
- Recommended Air Pressure: 90 psi



WARRANTY: 1 Year

Offer Good Through June 30, 2025

OEM TOOLS®

SAVE \$10

## Inflators

### Digital Tire Inflator

SKU 802198 **69<sup>99</sup>**  
24412

- Easy-to-Read Backlit LCD Display
- 4 Units of Measure (psi, Bar, KPa, kgf)
- Measuring Range: 0 to 175 psi (0 - 12 Bar)
- Accuracy: +/-1.2 psi Up to 58 psi, +/-2.3 Between 58 psi and 145 psi Inclusive, +/-3.6 psi Greater Than 145 psi
- High Air Flow Saves the Technician Time



2 AAA

OEM TOOLS®

### Dial Tire Inflator

SKU 301772 **59<sup>99</sup>**  
24380

- Clear and Easy-to-Read 80 mm 180 psi Gauge
- 3-In-1 Function: Inflate, Deflate and Measure Tire Pressure
- Increased Accuracy to Improve Tire Performance and Prevent TPMS Comebacks



OEM TOOLS®

### 3.5" Digital Tire Inflator with Hose

SKU 1268419 **99<sup>99</sup>**  
AST3018

- 21" Stainless Braided Hose
- Dual AAA Battery Powered Design
- Backlit LCD Digital Read-Out
- Includes Batteries



Astro

### Dual Head Chuck Tire Inflator Gauge

SKU 094652 **29<sup>99</sup>**  
25864

- 6" Chrome Plated Dual-Head Chuck with Full 360° Swivel Action
- 15" Air Hose with 1/4" Female NPT and 3/8" 24 Thread Air Intake
- Inflates within 10 to 120 Lb. Pressure Range
- Magnifying Bubble Lens, Allows Full View of the Pressure Scale
- Gauge in 2 Lb. Increments

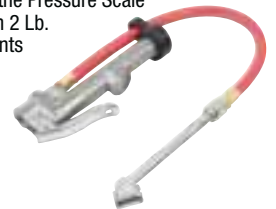

OEM TOOLS®

# AIR TOOL ACCESSORIES

TO ORDER, contact your Commercial Sales Manager or go to [AutoZonePro.com](http://AutoZonePro.com)

AIR TOOL ACCESSORIES

## Impact Sockets and Extensions

### 1/2" Drive Impact Extension Set

SKU 1340235 **99<sup>99</sup>**  
SUN2500

- Set Includes: 1/2" Dr. 3", 5", 10" and 15" Impact Extensions
- Comes in a Blow Mold Case



### 3/8" Impact Sockets

- 6 Pt. High Quality Impact Sockets
- SAE: 5/16", 3/8", 7/16", 1/2", 9/16", 5/8", 11/16", 3/4", 13/16", 7/8", 15/16" and 1"
- Metric: 8, 9, 10, 11, 12, 13, 14, 15, 16, 17, 18 and 19 mm



**Posi-Grip No Slip™ Design Provides Superior Gripping Power for Maximum Torque**  
**Chrome Moly Steel Construction for Strength and Durability**

### 12 Piece Shallow (SAE)

SKU 391191  
25589

**29<sup>99</sup>**

### 12 Piece Shallow (Metric)

SKU 391190  
25587

**29<sup>99</sup>**



### 12 Piece Deep (SAE)

SKU 442193  
25590

**39<sup>99</sup>**

### 12 Piece Deep (Metric)

SKU 464314  
25588

**39<sup>99</sup>**



### 33 mm 1" Drive Budd Style Wheel Socket

SKU 466569 **19<sup>99</sup>**  
25528

- 1" Drive 33 mm Budd Wheel Socket for Mack, Midliner, Volvo, White and Other Import Trucks with Dual Rear Wheels



### 1/2" Impact Sockets

- 6 Pt. High Quality Impact Sockets
- SAE: 3/8", 7/16", 1/2", 9/16", 5/8", 11/16", 3/4", 13/16", 7/8", 15/16" and 1"
- Metric: 10, 11, 12, 13, 14, 15, 16, 17, 18 and 19 mm



### 11 Piece Shallow (SAE)

SKU 391195  
25593

**32<sup>99</sup>**

### 10 Piece Shallow (Metric)

SKU 391192  
25591

**29<sup>99</sup>**



### 11 Piece Deep (SAE)

SKU 391196  
25594

**42<sup>99</sup>**

### 10 Piece Deep (Metric)

SKU 391194  
25592

**39<sup>99</sup>**



### 1-1/2" Hex x 13/16" Square Deep 1" Drive Budd Style Wheel Socket

SKU 466570 **24<sup>99</sup>**  
25529

- For Budd Wheel 1-1/2" Hex with 13/16" Inside Square



## Impact Adapters



### 5 Piece Adapter and Universal Joint Set (3/8" and 1/2")

SKU 965864 **34<sup>99</sup>**  
24226

- Chrome Moly Steel Construction
- Includes: 3/8" Drive Universal Joint, 3/8" Drive (F) x 1/2" (M) Adapter, 1/2" Drive Universal Joint, 1/2" Drive (F) x 3/8" (M) Adapter and 1/2" Drive (F) x 3/4" (M) Adapter



## Air Blow Gun



### 5 Piece Interchangeable Tip Air Blow Gun

SKU 338823 **21<sup>99</sup>**  
24439

- Includes 4 Interchangeable Tips: 100 mm (4"), 140 mm (5.5"), 320 mm (12.5") and a Turbo Wide Angle Nozzle
- Quick Change Coupling Makes it Easy to Change Tips
- Wide Angle Nozzle for High Volume
- Variable Trigger to Control Volume and Tip Pressure
- 1/4" NPT Air Inlet

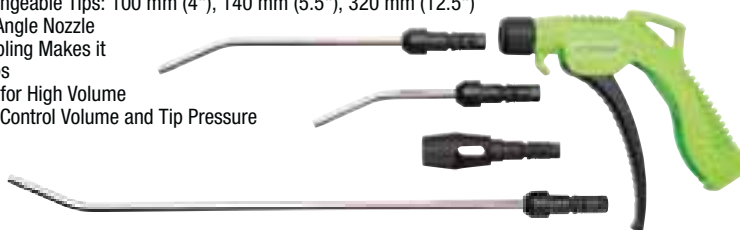

## High Flow Couplers

### High Flow Coupler and Plug Kits

**70% MORE FLOW\***

- Ideal for HVLP Spray Guns and High Torque Impact Wrenches
- Delivers the Highest Air Volume with the Lowest Pressure Drop



### 14 Piece 1/4" Body, 1/4" NPT

SKU 757091 **21<sup>99</sup>**  
26134



### 7 Piece 1/4" Body, 1/4" NPT

SKU 757040 **13<sup>99</sup>**  
26132



### 7 Piece 1/4" Body, 3/8" NPT

SKU 757046 **13<sup>99</sup>**  
26133



\*When Paired Together, OEMTOOLS High Flow Couplers and Plugs Deliver Up to 70% More Flow than Conventional Couplers

Prices subject to change without notice. Prices do not include applicable taxes, vehicles, tires, rims, installation or optional equipment as shown. Please do not return purchases to the store. For information regarding warranty, repair, or any questions or concerns, call 901-300-4878.

AZG0225

75

# AIR TOOL ACCESSORIES

## Hoses and Hose Reels

### 50' Nitrile Rubber

- Lays Flat Under Pressure for Easy Maneuverability and Safety
- Meets PFAS-Free Regulations
- Resists Abrasions and Kinks
- UV Protective Material
- Excellent Resistance to Grease, Oil and Weather

**3/8"**  
SKU 1491310  
LIN72N3850  
**54<sup>99</sup>**

- 1/4" NPT Brass Fittings



**1/2"**  
SKU 1491309  
LIN72N1250  
**84<sup>99</sup>**

- 1/2" NPT Brass Fittings

### 50' Premium Hybrid

- Lightweight Design for Ease of Use and Enhanced Portability
- Kink Resistant with All-Weather Flexibility (-40° to 150°F)

**3/8"**  
SKU 1491308  
LIN72H3850  
**54<sup>99</sup>**

- 1/4" NPT Brass Fittings

**1/2"**  
SKU 1491307  
LIN72H1250  
**84<sup>99</sup>**

- 1/2" NPT Brass Fittings

### 3/8" x 50' Hybrid Polymer Air Hose with Reel

SKU 347224  
24424 **124<sup>99</sup>**

- Heavy Duty Polymer Hose Material Redefines Flexibility - Stays Flexible Under All Weather Conditions (-40° to 150°F)
- Holds No Memory - Kink Resistant Under Pressure
- 300 psi Working Pressure
- Bend Restriction for Reducing Wear and Tear and Extending Life of Hose
- Solid Brass MNPT Ends



### 1/2" x 4' Air Hose

SKU 347221  
24421 **19<sup>99</sup>**

- 3/8" Swivel MNPT x 3/8" MNPT



### Value Series Air Hose Reel

- Retractable Delivery Hose
- Durable Heavy Gauge Steel Construction
- Slotted Mounting Base for Easy Installation

**3/8" x 50'**  
SKU 972284  
LIN83753  
**289<sup>99</sup>**

**1/2" x 50'**  
SKU 972285  
LIN83754  
**314<sup>99</sup>**



### 3/8" x 50' Air Hose Reel

SKU 900815  
25979 **159<sup>99</sup>**

- Smooth Automatic Retracting Spring Coil
- 50' Hose
- 3/8" NPT Fittings
- Max. Pressure: 250 psi



(Color May Vary)



## Air Piping

### MaxLine Compressed Air Piping System 3/4" Master Kit

SKU 360593  
RAPM7500 **269<sup>99</sup>**

- **Aluminum Core: Holds Any Bent Shape!**
- Heavier Duty Components for Longer Air Runs in Larger Buildings
- 3 Air Outlets, (1) 3/4" NPT Straight Fitting, 2 Tees, 20 Clips and 100' of 3/4" HDPE Tubing



### 1/2" Tubing Master Kit

SKU 360485  
RAP90500 **169<sup>99</sup>**

- Easily Install Behind Walls of New Construction or on Existing Shop Walls
- Includes: 2 Air Outlet Kits, 1 Compressor Manifold Kit, 100' Nylon Tubing and Tubing Cutter



### 3/4" MaxLine Outlet Kit

SKU OUTSIDE BUY/EPO  
RAPM7510

**64<sup>99</sup>**

- 3/4" Outlet Kit for MaxLine Compressed Air System

For Outside Buy/EPO,  
Call 901-300-4878



## Air Chuck

### Dual Foot Air Chuck with Comfort Grip Handle

SKU 802201  
24413 **24<sup>99</sup>**

- Comfortable Screwdriver Style Handle
- 30° Reverse Angle Chuck Can Be Used on Outside Tires
- Tilt Lock Feature Locks onto the Valve



### Air Chuck with Comfort Grip Handle

SKU 802200  
24414 **19<sup>99</sup>**

- Durable, OEMTOOLS Screwdriver Style Handle for Comfort and a Positive Grip
- Sealed-Ball Air Chuck is Extended 1" from Handle to Allow Access to Tight Areas



See More RapidAir® Products on AutoZonePro.com

# AIR TOOL ACCESSORIES

TO ORDER, contact your Commercial Sales Manager or go to [AutoZonePro.com](http://AutoZonePro.com)

AIR TOOL ACCESSORIES

## Surface Prep

### 2" Twist-to-Lock Surface Prep Discs (50 Pack) with Cookie Jar

**Coarse**  
SKU 1146029  
SHA13088 **84<sup>99</sup>**

**Medium**  
SKU 1146030  
SHA13089 **84<sup>99</sup>**



### 2" Surface Prep Discs (25 Pack)

• Twist-Lock Style  
**Coarse**  
SKU 1330684  
22517 **19<sup>99</sup>**  
(0.79 each)

**Medium**  
SKU 1335806  
22516 **19<sup>99</sup>**  
(0.79 each)



### 3" Surface Prep Discs (25 Pack)

• Twist-Lock Style  
**Coarse**  
SKU 1335795  
22518 **24<sup>99</sup>**  
(0.99 each)

**Medium**  
SKU 1335787  
22519 **24<sup>99</sup>**  
(0.99 each)



## Assorted

SKU 1168677 **49<sup>99</sup>** REG. 84.99  
SHA13087

**SAVE \$35**

• Includes: Coarse, Medium and Fine

Offer Good Through June 30, 2025

## Twist-Lock Disc Holders

SKU 1368617 **17<sup>99</sup>**  
SHA13012

• 2" Holder (Single)

SKU 094911 **29<sup>99</sup>**  
SHA323T2

• 2" Holder (2 Pack)

SKU 094916 **29<sup>99</sup>**  
SHA333T2

• 3" Holder (2 Pack)



SKU 094912 **29<sup>99</sup>**  
SHA323TB  
• 2" and 3" Holder Set



## 2" Purple Strip Disc with Twist-Lock (5 Pack)

SKU 298097 **24<sup>99</sup>**  
SHA16206

• Long-Life Silicon Carbide for Paint and Coating Removal  
• Pack of 5 Discs



## 2" Twist-Lock Mini Flap Discs Assorted Grits (6 Pack)

SKU 306275 **39<sup>99</sup>**  
SHA13056

• Outlasts Mini Grinding Discs by 3 Times  
• Includes: 2 Each of 40, 60 and 80 Grit



## 3" Green 50G Finger Discs (10 Pack)

SKU 1362011 **169<sup>99</sup>**  
SHA13361

• Long Life Discs with Type "R" Style Backing  
• Improved Surface Contact Over Wire Brushes  
• Great for Rust, Surface Contamination and Oxide Removal from Metals



**Ideal for Hard-to-Reach Surfaces and Lasts Longer than Most Abrasive Discs**



## Twist-to-Lock Green Zirconia Mini Grinding Discs

### Green Zirconia

SKU	Part #	Size	Grit	Qty	Price
306282	SHA12613	2"	36	25	<b>39.99</b>
305896	SHA12614	2"	50	25	<b>39.99</b>
204022	SHA12615	2"	80	25	<b>39.99</b>
306323	SHA12617	3"	36	25	<b>49.99</b>
305827	SHA12618	3"	50	25	<b>49.99</b>
204009	SHA12619	3"	80	25	<b>49.99</b>



## Cut-Off Accessories

### Mandrel Set for Cut-Off Tools (2 Pack)

SKU 094907 **29<sup>99</sup>**  
SHA32



### 10 Piece Cut-Off Wheel Set with Mandrel

SKU 1400046 **14<sup>99</sup>**  
26528

• Capable of Cutting Fiberglass, Plastic, Iron, Steel and Other Ferrous Metals  
• Quantity: (10) 3" x 1/16" Cut-Off Wheels with 3/8" Arbor, 46 Grit  
• Max. RPM: 20,400



### 3" Aluminum Cutting Wheels (10 Pack)

SKU 306331 **59<sup>99</sup>**  
SHA13178PK2

• Silicon Carbide Grain  
• Includes: (10) 3" x 1/16" x 3/8" Cut-Off Wheels  
• Works on 3" Die Grinders



### 3" x 1/16" x 3/8" Reinforced Cut-Off Wheels (25 Pack)

SKU 306273 **44<sup>99</sup>**  
SHA25E5PK5

• For Use with Pneumatic Cut-Off Tools  
• Max. RPM: 25,000  
• Includes: 25 Discs



Prices subject to change without notice. Prices do not include applicable taxes, vehicles, tires, rims, installation or optional equipment as shown. Please do not return purchases to the store. For information regarding warranty, repair, or any questions or concerns, call 901-300-4878.

AZG0225

77

# POWER TOOLS

## Professional OEMTOOLS®

20V Max\* Li-ion  
**Heavy Duty 1/2" Impact Wrench**  
 SKU 818594 **109<sup>99</sup>**  
 24481

- Speed: 0 to 2,200 RPM and 0 to 2,900 IPM
- Nut Busting Torque: 300 Ft/Lb.
- Tightening Torque: 260 Ft/Lb.
- Weight: 8 Lb.
- Battery Light Indicators
- Charge Time: 2 Hrs.
- Includes: 4.0Ah Li-ion Rechargeable Battery with Charging Station and Sturdy Blow Mold Storage Case



20V Max\* Li-ion  
**1/2" Brushless Impact Wrench**  
 SKU 592251 **179<sup>99</sup>**  
 24486

- Variable Speed: 0 to 2,600 RPM and 0 to 3,000 IPM
- Nut Busting Torque: 300 Ft/Lb.
- Tightening Torque: 260 Ft/Lb.
- Charge Time: 2 Hrs.
- Weight: 9.28 Lb.
- Includes: Rechargeable 4.0Ah Li-ion Battery, Charging Station and Sturdy Blow Mold Storage Case



OEMTOOLS®

20V MAX LI-ION

BRUSHLESS MOTOR

20V Max\* Li-ion  
**1/2" Brushless Hammer Drill**  
 SKU 593469 **149<sup>99</sup>**  
 24485

- Variable Speed: 0-600 RPM and 0-2000 RPM
- Max. Torque: 310 In/Lb.
- Electric Brake
- Clutch: 21 + 1 Torque Setting
- Charge Time: 1 Hour
- Includes: Rechargeable 2.0Ah Li-ion Battery, Charging Station and Sturdy Blow Mold Storage Case



20V Max\* Li-ion  
**Cordless Angle Grinder**  
 SKU 598786 **134<sup>99</sup>**  
 24492

- Speed: 0 to 10,000 RPM
- Max. Disc Diameter: 4-1/2"
- Spindle Thread: 5/8"
- Spindle Lock: Yes
- Charge Time: 2 Hrs.
- Includes: Grinding Disc, Assist Handle, Rechargeable 4.0Ah Li-ion Rechargeable Battery and Charging Station



20V Max\* Li-ion  
**Reciprocating Saw**  
 SKU 592353 **89<sup>99</sup>** **SAVE \$10**  
 24491 REG. \$99.99

- Variable Speed: 0 to 3,000 RPM
- Overall Length: 14-1/4"
- Charge Time: 1 Hour
- Includes: High-Quality, Multi-Purpose Bi-Metal Reciprocating Saw Blade, Rechargeable 2.0Ah Li-ion Battery and Charging Station



Offer Good While Supplies Last Through June 30, 2025

### All Professional OEMTOOLS 20V Power Tools Work with:

**Battery Charger**  
 SKU 824778 **49<sup>99</sup>**  
 27333B

- Replacement Part for OEMTOOLS Heavy Duty 1/2" 2VSR Cordless 20V Li-ion Drill



### Replacement Batteries

**2.0Ah**  
 SKU 824777 **64<sup>99</sup>**  
 27333A

**4.0Ah**  
 SKU 824772 **99<sup>99</sup>**  
 27314AM



\*With respect to 20V Max, Maximum initial battery voltage (measured without a workload) is 20 volts. Nominal voltage is 18V.

## Corded OEMTOOLS®

**Oscillating Tool**  
 SKU 592331 **54<sup>99</sup>**  
 24495

- Includes: 3-1/2" Semi-Circle Wood Saw Blade, 2" Rigid Scraper, 1-1/4" Wood Plunge Blade, Standard Sanding Pad and (3) 60/80/120 Grit Sandpapers and 6 Ft. Power Cord
- Variable Speed: 11,000 to 20,000 OPM
- Power: 2.3 Amps
- Overall Length: 14-1/2"
- Power Cord Length: 6 Ft.



OEMTOOLS®

**6" Bench Grinder with Lamp**  
 SKU 412598 **129<sup>99</sup>**  
 80058

- Solid, Heavy Duty Construction for Shaping and Sharpening Hardened Steel
- 6" Wheels with Tool Rests
- Tool Rests Adjust to 45° or 90° Position
- Includes: Coarse and Fine 6" Grinder Wheels, Goose Neck Lamp, Adjustable Eye Guards and Spark Breakers



OEMTOOLS®

SHARK USA

**Bench Grinding Wheel**  
**6" X 3/4" 46 Grit**  
 SKU 112398 **39<sup>99</sup>**  
 SHA2017

- Economical, Long Lasting Abrasive Wheels



**14" Chop Saw**  
 SKU 1228718 **239<sup>99</sup>**  
 24723

- Ideal for Cutting Wood, Metal, Steel and Pipe
- 15 Amp Motor for Powerful Cutting Action
- Spindle Lock Makes Wheel Changes Quick and Easy
- Accepts Standard 14" Cutoff Discs
- Includes: Cutting Blade and 6 Ft. Power Cord



OEMTOOLS®

**7" Variable Speed Polisher**  
 SKU 592258 **79<sup>99</sup>**  
 24496

- No-Load Speed: 1000 to 3000 RPM
- Power: 11 Amps
- Spindle Thread: 5/8"
- Spindle Lock: Yes
- Power Cord Length: 6 Ft.
- Includes: Sanding Paper, Sanding Pad, Terry Bonnet, Wool Bonnet and Foam Piece



OEMTOOLS®

## OEMTOOLS®

20V Max\* Li-ion  
**3/8" Cordless Drill**  
SKU 052383 **67<sup>99</sup>**  
24660

- Chuck Size: 1/2" Keyless Jacob's Chuck
- No-Load Variable 2 Speed Gear Box: 0 to 350 RPM and 0 to 1,150 RPM
- Max. Torque: 220 In/Lb.
- Max. Drilling Capacity: 5/16" (Metal) and 3/4" (Wood)
- Keyless, Auto Spindle Lock Chuck Size: 3/8"
- Clutch: 16 + 1 Torque Clutch Setting
- Electric Brake
- Forward and Reverse Switch
- Battery Charge and Capacity Indicator Lights
- Charge Time: 4 to 6 Hrs.
- Includes: 1.5Ah Li-ion Rechargeable Battery and Battery Charger



20V  
MAX  
LI-ION

20V Max\* Li-ion  
**3/8" Cordless Impact Wrench**

SKU 052379 **82<sup>99</sup>**  
24661

- Anvil: Heat-Treated 3/8" Drive Ball Detent
- Variable Speed: 0 to 2,400 RPM and 0 to 3,000 IPM
- Max. Torque: 200 Ft/Lb. (Forward) and 240 Ft/Lb. (Reverse)
- Battery: 1.5Ah Li-ion
- Electric Brake
- Battery Charge and Capacity Indicator Lights
- Charge Time: 3 to 5 Hrs.
- Includes: 1.5Ah Li-ion Rechargeable Battery and Diagnostic Fast Battery Charger



20V  
MAX  
LI-ION

20V Max\* Li-ion  
**1/2" Cordless Impact Wrench**

SKU 052380 **99<sup>99</sup>**  
24670

- Anvil: 1/2" Square Drive
- Speed: 0 to 2,200 RPM; 0 to 2,700 IPM
- Nut Busting Torque: 300 Ft/Lb.
- Max. Tightening Torque: 240 Ft/Lb.
- Battery: 2.0Ah Li-ion
- Weight: 6.5 Lb.
- Charge Time: 5 to 7 Hrs.
- Includes: 2.0Ah Li-ion Rechargeable Battery, Li-ion Battery Charger



OEM TOOLS®

20V  
MAX  
LI-ION

STORE STOCKED

STORE STOCKED

STORE STOCKED

Individual Batteries and Charger Available

20V Max\* Li-ion  
**Battery 1.5 Amps**  
SKU 029415  
24660A **45<sup>99</sup>**

- Charges in 4 to 6 Hrs.



20V Max\* Li-ion  
**Battery 2.0 Amps**  
SKU 1392334  
24670-36 **49<sup>99</sup>**

- Charges in 4 to 6 Hrs.



20V Max\* Li-ion  
**Battery Charger**  
SKU 029418  
24660B **19<sup>99</sup>**



**4-1/2" Compact Angle Grinder**

SKU 052382 **43<sup>55</sup>**  
24663

- Motor: 6 Amp
- Voltage: 120V, 60 Hz
- Speed: 10,500 RPM
- Interchangeable Handle for Left or Right Hand Use
- Heavy Duty, Cast Aluminum Gear Head for Strength and Durability
- 6 Ft. Power Cord
- Includes: Grinding Wheel, Spanner Wrench and Disc Guard



**Heavy Duty 1/2" Impact Wrench**

SKU 052388 **69<sup>99</sup>**  
24666

- Input Power: 8.5 Amp
- Voltage: 120V, 60 Hz
- 1/2" Square Drive with Hog Ring Retainer
- No-Load Speed: 0 to 2,200 RPM and 0 to 3,000 IPM
- Replaceable Carbon Brushes
- 8 Ft. Power Cord



STORE STOCKED

STORE STOCKED

**Rotary Tool with 35 Piece Accessory Kit**

SKU 052384 **37<sup>99</sup>**  
24664

- Input Power: 1.2 Amp
- Voltage: 120V, 60 Hz
- No-Load Speed: 10,000 to 35,000 RPM
- Collet Capacity: 1/8" to 3/32"
- Spindle Lock for Easy Bit and Accessory Change
- 6 Ft. Power Cord
- Includes: Grinding Stones, Wheels, Brush, Sanding Bands and Disc, plus Grinding, Cloth and Cut-Off Wheels



Includes 35 Piece Accessory Kit



**Flexible Shaft Rotary Tool Extension**

SKU 003483 **21<sup>99</sup>**  
24657

- Easily Attaches to Many Popular Rotary Tools

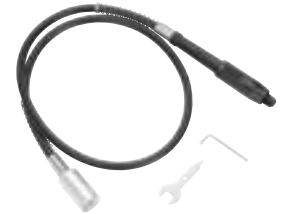

STORE STOCKED

12V Max\*\* Li-ion  
**Power Ratchet**

SKU 1069064 **69<sup>99</sup>**  
24685

- Max. Torque: 35 Ft./Lb.
- Max. Manual Torque: 96 Ft./Lb.
- No-Load Speed: 230 RPM
- Ergonomic Grip with Low-Profile Head for Work in Tight Spaces
- Features Integrated Worklight for Hard-to-See Spots
- Includes: 2Ah Li-ion Removable Battery and Charger



**Dual Temp Heat Gun**

SKU 052387 **29<sup>69</sup>**  
24665

- Input Power: 10 Amp
- Voltage: 120V, 60 Hz
- Temperature Settings: 482°F/842°F
- Trigger: 3 Position Rocker
- Hanging Loop for Storage
- 6 Ft. Power Cord



STORE STOCKED

\*With respect to 20V Max, Maximum initial battery voltage (measured without a workload) is 20 volts. Nominal voltage is 18V.

\*\*With respect to 12V Max, Maximum initial battery voltage (measured without a workload) is 12 volts. Nominal voltage is 10.8V.

Prices subject to change without notice. Prices do not include applicable taxes, vehicles, tires, rims, installation or optional equipment as shown. Please do not return purchases to the store. For information regarding warranty, repair, or any questions or concerns, call 901-300-4878.

# POWER TOOLS

## Power Tool Accessories

### 33 Piece Impact Rated Driving Bit Set

SKU 750443  
25960

**14<sup>99</sup>**



- Designed to Withstand High Torque Applications
- Reduces Wear, Stripping and Cam-Out
- Includes: Magnetic Impact Rated Bit Adapter



### 6 Piece Bi-Metal Hole Saw Set

SKU 547011  
24378

**19<sup>99</sup>** REG. \$24.99

**SAVE \$5**

- Includes: Sizes: 7/8", 1", 1-1/8", 1-1/4" and 1-1/2" (22 mm, 25 mm, 29 mm, 32 mm and 38 mm)
- Slotted Saw Allows for Easier Plug Removal
- Durable Enamel Finish Protects Against Corrosion
- Bi-Metal Construction for Increased Wear Resistance



Offer Good Through June 30, 2025

### Multi-Purpose Drill Powered Pump

SKU 526513  
24503

**24<sup>99</sup>**

- Works with a Corded or Cordless Drill to Transfer the Following Liquids: Fresh Water, Sea Water, Organic Solvents, Motor Oil, Heating Oil, Insecticides and Liquid Fertilizers



### Bench Grinder, Vise and Drill Press Stand

SKU 943120  
24643

**129<sup>99</sup>**

- Heavy Duty Steel Construction Features Large Base to Prevent Walking or Wobbling During Operation and is Pre-Drilled for Mounting
- Top/Plate Dimensions: 13.8"(L) x 9.8"(W) x 0.2"(H)
- Overall Dimensions: 13.8"(L) x 9.8"(W) x 37.4"(H)

Multiple Mounting Configurations Fit Many Bench Grinders, Pipe Benders, Vises and Drill Presses



### 4-1/2" x 1/16" x 7/8" Cut Off Wheel Pack of 6

SKU 1485031  
26510PK

**19<sup>99</sup>**

- 4-1/2" Wheel Diameter
- 1/16" Wheel Thickness
- 7/8" Arbor Diameter
- Will Evenly Cut Through Fiberglass, Plastic and Steel
- Arbor Diameter Fits Most Drills



### 3 Piece Spiral Step Drill Set

SKU 99189  
24372

**27<sup>99</sup>**

- Titanium Two-Flute Spiral for Longer Life, Faster Drilling and Less Vibration
- Split Point Generates Less Heat
- Bit One: 13 Sizes from 1/8" to 1/2"
- Bit Two: 6 Sizes from 3/16" to 1/2"
- Bit Three: 9 Sizes from 1/4" to 3/4"
- 28 Hole Sizes in 3 Bits
- Enlarge Existing Holes
- 1/4" Hex Shank To Prevent Slipping in Chuck Applicable
- Materials: Stainless Steel, Copper, Brass, Aluminum, Plastic and Laminates (Material Thickness of 0.125")



### 4.5" Depressed Center Grinding Wheels

SKU 1485045  
SHA12734

**14<sup>99</sup>**

- Type 27 Aluminum Oxide Grinding Wheels
- Arbor: 7/8"
- Diameter: 4.5 by 1/4"
- Hubless, 24 Grit
- Pack Contains 3 Wheels



## Mechanics Set

SKU 533204 | 24974

**1,649<sup>99</sup>** REG. \$1,807.51

**SAVE \$157**

### Includes 156 of the Most Common Tools in Tool Cart

- SAE and Metric, 1/4", 3/8" and 1/2" Drive Tools, Combination Wrench Sets, Pliers and Screwdrivers. Plus Battery Service Tools, Oil Change Tools and More



Cart Style and Color May Vary

Offer Good While Supplies Last Through June 30, 2025

## Technicians Set

SKU 533203 | 24975

**2,249<sup>99</sup>** REG. \$2,526.22

**SAVE \$276**

### Includes 312 of the Most Common Tools in Tool Cart

- SAE and Metric, 1/4", 3/8" and 1/2" Drive Tools, Combination Wrench Sets, Pliers and Screwdrivers. Plus Battery Service Tools, Oil Change, Wheel Service and More



Cart Style and Color May Vary

Offer Good While Supplies Last Through June 30, 2025



# JACKS & HYDRAULICS

TO ORDER, contact your Commercial Sales Manager or go to [AutoZonePro.com](http://AutoZonePro.com)

JACKS & HYDRAULICS

## Floor Jacks

### 2 Ton Off-Road Jack

SKU 1525571 **299<sup>99</sup>**  
29004

**NEW**

- Full Length Skid Plate Provides Stability In Soft or Unstable Materials Such as Sand or Gravel
- Heavy Duty Oversized Wheels are Ideal for Navigating on Rough or Uneven Surfaces
- High Lift Adapter Extension for Additional Lift Height Up to 24-3/16" Provides Access to Lifting Points for Off Road Vehicles
- Dual Piston Hydraulic System for Quicker, More Efficient Lifting
- Min. Height without Extension: 6-1/8", with Extension Stage: 11-1/4"
- Max. Height: without Extension: 17-15/16", with Extension Stage: 24-3/16"
- Weight: 59.5 Lb.
- Padded Jack Handle to Prevent Scratches and Dents



**PADDED HANDLE**

**24 3/16" MAX HEIGHT**

**OEM TOOLS**

24-3/16" Extension

Full-Length Skid Plate



Heavy Duty Oversized Wheels



Carry Handle for Portability



Locking Adjustable Height Extender

### 4 Ton Hydraulic Service Jack

SKU 1525558 **349<sup>99</sup>**  
29003

**NEW**

- Dual Piston Hydraulic System for Quicker More Efficient Lifting
- Nylon Casters Protect Sealed Floor Surfaces and Dealer Showrooms
- Meets ASME PASE-2019 Standards
- 4.3" Saddle Provides Generous Lifting Area and Secure Grip
- Min. Height: 4-3/8"
- Max. Height: 20-1/4"
- Weight: 98.3 Lb.

**20 1/4" MAX HEIGHT**

**PADDED HANDLE**



### 3 Ton Long/Low Signature Service Jack

SKU 1407611 **279<sup>99</sup>**  
24868

- Extra Long and Low Profile is Great for Low Clearance Vehicles, Pickups and SUVs
- Padded Jack Handle and Saddle Pad to Prevent Vehicle Damage
- Dual Pump Design for Quicker Lifting
- Nylon Casters to Protect Sealed Floor Surfaces and Dealer Showrooms
- Min. Height: 3-3/8"
- Max. Height: 24-1/4"
- Length: 31-3/8"
- Weight: 100.3 Lb.

**3 3/8" LOW PROFILE**

**LONG REACH**

**PADDED HANDLE**



### 2-1/2 Ton Aluminum/Steel Hybrid Floor Jack

SKU 1417557 **199<sup>99</sup>**  
24869

- Aluminum and Steel Frame Construction Provides the Benefit of Strength Along with Light Weight
- Padded Jack Handle and Saddle Pad to Prevent Damage to Vehicle
- Dual Pump Design for Quicker Lifting
- Nylon Casters to Protect Sealed Floor Surfaces and Dealer Showrooms
- Min. Height: 3-1/2"
- Max. Height: 19-1/4"
- Length: 25-1/2"
- Weight: 58.2 Lb.

**3 1/2" LOW PROFILE**

**PADDED HANDLE**



### 3-1/2 Ton Low Profile Floor Jack

SKU 757109 **219<sup>99</sup>**  
24837

**3 3/4" LOW PROFILE**

**PADDED HANDLE**

- Dual Pump Design for Quicker Lifting
- Min. Height: 3-3/4"
- Max. Height: 20-1/2"
- Length: 27-1/8"
- Weight: 85.8 Lb.



### 2-1/2 Ton Low Profile Floor Jack

SKU 1089029 **209<sup>99</sup>**  
24791

**3 1/8" LOW PROFILE**

**PADDED HANDLE**

- Dual Pump Pistons for a Quick Lift Design
- Min. Height: 3-1/8"
- Max. Height: 19-3/4"
- Length: 26-1/4"
- Weight: 69.5 Lb.



### 2 Ton Extra Long, Extra Low Profile Floor Jack

SKU 757041 **279<sup>99</sup>**  
24838

**2 3/4" LOW PROFILE**

**LONG REACH**

**PADDED HANDLE**

- Min. Height: 2-3/4"
- Max. Height: 24-1/4"
- Length: 31-7/8"
- Weight: 97.5 Lb.



All OEMTOOLS® Jacks on this page include overload and bypass safety valves and meet ASME PASE 2014 Safety Standards.

Prices subject to change without notice. Prices do not include applicable taxes, vehicles, tires, rims, installation or optional equipment as shown. Please do not return purchases to the store. For information regarding warranty, repair, or any questions or concerns, call 901-300-4878.

AZG0225

# JACKS & HYDRAULICS

## Wheel Dollies

### Mechanical Vehicle Position Dollies

- Easily Lift and Move Vehicles Up to 6,000 Lb.
- 1,500 Lb. Capacity Each

### Set of 2 Dollies

SKU 1089031  
24793

**249<sup>99</sup>**



**Set of 4 Dollies with Storage Cradle**  
SKU 1414391  
69000

**OEM TOOLS®**

**499<sup>99</sup>**

REG. \$564.97

**SAVE OVER \$64**

When You Buy the Set



### Hydraulic Vehicle Position Dollies

- Easily Lift and Move Vehicles Up to 6,000 Lb.
- 1,500 Lb. Capacity Each

### Set of 2 Dollies

SKU 298098  
24855TWO

**299<sup>99</sup>**



**Set of 4 Dollies with Storage Cradle**  
SKU 696485  
68986

**599<sup>99</sup>**

REG. \$664.97

**SAVE OVER \$64**

When You Buy the Set



### 1500 Lb. Wheel Dollies Set

SKU 814384  
24858

**119<sup>99</sup>**

**NEW**

- Great for Moving Cars, Trucks, Trailers and Lawn Tractors
- 4 Swivel Nylon Casters Give Mobility in All Directions, Roll Smoothly and are Safe for Epoxy Floors
- HD Steel Plate Construction for a Long Life
- 2 Casters on Each Dolly Have Locking Mechanisms



### Vehicle Position Dolly Cradle

SKU 544800  
24856

**64<sup>99</sup>**

- Neatly Secure and Store Up to 4 Vehicle Car Dolly Jacks



Price does not include jacks

## Air Hydraulic Jacks

**OEM TOOLS®**

### 20 Ton Air Hydraulic Bottle Jack

SKU 544795  
24850

**129<sup>99</sup>**

- Can Be Operated with Air or Manually
- Height: 10.25" to 20.1"
- Extension Screw Adjustment: 3.15"
- Meets or Exceeds ASME PASE-2019 Standards



### 22 Ton Air Hydraulic Truck Jack

SKU 544796  
24851

**379<sup>99</sup>**

- Compact, Low Profile Design Easily and Safely Fits Between Wheels of Tandem Axle Vehicles
- Ram Travel: 4-15/16"
- Extension Screw Adjustment: 4"
- Min. Height: 8-3/4"
- Max. Height: 17-11/16"



**Hydraulic Jacks Built for Performance and Ease of Use**

## Jack Stands

**OEM TOOLS®**

### 3 Ton Jack Stands (Pair)

SKU 757122  
24852

**59<sup>99</sup>**

- Min. Height: 11"
- Max. Height: 16-1/2"
- Meets or Exceeds ASME PASE-2019 Standards



### 6 Ton Jack Stands (Pair)

SKU 757050  
24853

**99<sup>99</sup>**

- Min. Height: 15.75"
- Max. Height: 23.7"
- Meets or Exceeds ASME PASE-2019 Standards



### 22 Ton Heavy Duty Axle Stands (Pair)

SKU 757098  
24854

**179<sup>99</sup>**

- Min. Height: 12-1/4"
- Max. Height: 19-3/4"
- Adjustable Pin Design
- Features Handle for Transport and Positioning
- Large V-Shaped Saddles Center Lift Points for Secure Placement
- Meets or Exceeds ASME PASE-2019 Standards



**OEM TOOLS®**

### 6 Ton Ratcheting Jack Stand (Pair)

SKU OUTSIDE BUY/EPO  
VIK55060

**99<sup>99</sup>**

- Min. Height: 15.75"
- Max. Height: 24.38"
- Width: 11"



**VIKING**

For Outside Buy/EPO, Call 901-300-4878

Prices subject to change without notice. Prices do not include applicable taxes, vehicles, tires, rims, installation or optional equipment as shown. Please do not return purchases to the store. For information regarding warranty, repair, or any questions or concerns, call 901-300-4878.

# JACKS & HYDRAULICS

TO ORDER, contact your Commercial Sales Manager or go to [AutoZonePro.com](http://AutoZonePro.com)

JACKS & HYDRAULICS

## Transmission Jacks

### 1,000 Lb. Telescopic Transmission Jack

SKU 544786  
24840

**199<sup>99</sup>**

- Load Capacity: 1,000 Lb.
- Lowered Height: 51"
- Raised Height: 70"
- 2-Way Adjustable Saddle
- Heavy Duty Ram with Controlled Release Feature



70" REACH

### 1,100 Lb. High Lift Transmission Jack with Foot Pump

SKU 750006  
24844

**299<sup>99</sup>**

- Load Capacity: 1,100 Lb.
- Lowered Height: 47"
- Raised Height: 79"
- 4-Way Adjustable Saddle
- Spring-Loaded Release Valve Stops Lowering When You Let Go

Foot Pedal Pump and Release for Hands-Free Operation



79" REACH

### 1,100 Lb. 2 Stage Telescopic Transmission Jack

SKU 1089028  
24790

**499<sup>99</sup>** REG. \$699.99

- Second Stage Capacity: 1,100 Lb.
- Lowered Height: 37"
- Raised Height: 76.4"
- 4-Way Adjustable Saddle
- Fast Lifting Pump

SAVE \$200

Foot Pedal Pump and Release for Hands-Free Operation

Offer Good While Supplies Last Through June 30, 2025



76" REACH

### 1 Ton 2 Stage Telescopic Transmission Jack

SKU 1142678  
26842

**749<sup>99</sup>**

- Second Stage Capacity: 2,000 Lb.
- Lowered Height: 37.5"
- Raised Height: 76"
- 4-Way Adjustable Saddle
- Internal Shaft Retention to Prevent Leaks and Dirt Intrusion

Foot Pedal Pump and Release for Hands-Free Operation



76" REACH

### 800 Lb. Low-Profile Transmission Jack

SKU 544789  
24845

**349<sup>99</sup>**

SAVE \$80

REG. \$429.99

- Fully Adjustable Saddle Adapts to Most Transmission Pans
- Swivel Saddle Adjusts Both Directions
- Meets ANSI 2014 Standards
- Lowered Height: 8.5"
- Raised Height: 24.5"



24.5" REACH

Offer Good While Supplies Last Through June 30, 2025

### 1/2 Ton Transmission Jack

SKU OUTSIDE BUY/EPO  
RANRTJ1100

**649<sup>99</sup>**

- Lifting Capacity: 1,100 Lb.
- Lowered Height: 45"
- Raised Height: 72"

For Outside Buy/EPO, Call 901-300-4878

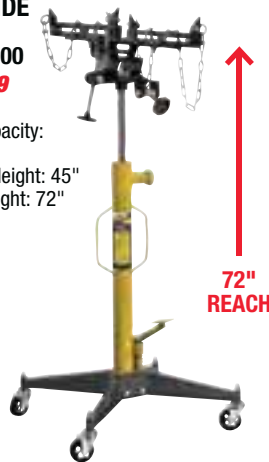

72" REACH

### 1 Ton Telescopic Transjak™ Transmission Jack

SKU OUTSIDE BUY/EPO  
RANRTJ1

**1,019<sup>99</sup>**

- Capacity First Stage: 2,000 Lb.
- Capacity Second Stage: 1,000 Lb.
- Lowered Height: 37"
- Raised Height: 71"

For Outside Buy/EPO, Call 901-300-4878



71" REACH

### 1-1/2 Ton Telescopic Transmission Jack

SKU OUTSIDE BUY/EPO  
RANRTJ3000

**1,079<sup>99</sup>**

- Capacity First Stage: 3,000 Lb.
- Capacity Second Stage: 2,000 Lb.
- Lowered Height: 35-1/2"
- Raised Height: 71-1/2"

For Outside Buy/EPO, Call 901-300-4878



71-1/2" REACH

### 1,100 Lb. Manual Transmission Jack

SKU 954229  
AFF3052

**1,229<sup>99</sup>**

- 2 Stage Telescopic Ram Designed for Medium Truck Transmissions, Transfer Cases and Differentials
- Chrome Plated Pump Core and Piston Rod Reduces Friction and Provides Long Service Life
- Powder Coat Finish Provides Resistance to Corrosion, Chemicals and Scratches
- Adjustable Saddle with Corner Bracket and Safety Chain
- Double Pump Hydraulic System for Quick Lift Operation
- Adheres to ASME 2014



78" REACH

### 1,100 Lb. Air Assist Transmission Jack

SKU 954225  
AFF3052A

**1,349<sup>99</sup>**

- 2 Stage Telescopic Ram Designed for Medium Truck Transmissions, Transfer Cases and Differentials
- Chrome Plated Pump Core and Piston Rod Reduces Friction and Provides Long Service Life
- Powder Coat Finish Provides Resistance to Corrosion, Chemicals and Scratches
- Adjustable Saddle with Corner Bracket and Safety Chain
- Double Pump Hydraulic System for Quick Lift Operation
- Adheres to ASME 2014



78" REACH

## You May Also Need

### Fuel Tank Adapter

SKU 1407554  
24832

**129<sup>99</sup>**

- Makes Fuel Tank Removal Safe and Easy
- Works with Most Transmission Jacks
- Includes: 2 Nylon Straps to Secure Tank
- Foam Rubber Pads Protect Tank

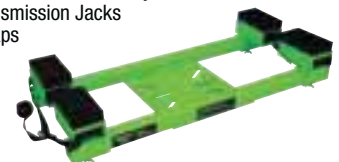

### Transmission Drain Pan

SKU 908383  
87035

**29<sup>99</sup>**

- Flexible Plastic Construction Fits on Top of Funnels for Most Lift Drains
- Built-In Screen to Catch Debris, Parts and Tools
- Dimensions: 22-3/4" (L) x 23-3/4" (W) x 4-3/4" (H)



Prices subject to change without notice. Prices do not include applicable taxes, vehicles, tires, rims, installation or optional equipment as shown. Please do not return purchases to the store. For information regarding warranty, repair, or any questions or concerns, call 901-300-4878.

AZG0225

83

# JACKS & HYDRAULICS

## Engine Stands

### 1,250 Lb. Engine Stand

SKU 462493 **149<sup>99</sup>**  
24829

- Easy to Move and Rotate
- Heavy Gauge Square Steel Tube Frame
- Extra Wide 4 Wheel Base Provides Added Stability
- 360° Rotation
- Lock Pin Locks Engine into Position



### Heavy Duty 1,000 Lb. Engine Stand

SKU 757115 **119<sup>99</sup>**  
24839

- Adjustable Mounting Arms to Fit Most Engine Configurations
- Locking Head Plate with 360° Engine Rotation
- Tubular Steel Construction
- Base: 32-1/2" (L) x 30-3/4" (W)
- Height: 37-3/8"
- Weight: 41.9 Lb.



### 1,100 Lb. Rotating Engine Stand

SKU 1125862 **349<sup>99</sup>**  
24798

- Adjustable Mounting Arms to Fit Most Engine Configurations
- Locking Head Plate with 360° Engine Rotation
- Heavy Duty Worm Gear for Effortless Rotation
- Tubular Steel Construction
- Folding Legs for Easy Storage
- Base: 41-1/4" (L) x 27-1/8" (W)
- Weight: 102.5 Lb.



### 1 Ton Folding Engine Stand

SKU 544804 **229<sup>99</sup>**  
24834

- Folds Upright to Conserve Valuable Floor Space
- Sturdy, Wide-Base Design to Prevent Tipping Under Load



OEM TOOLS®

## Shop Cranes

### 6,000 Lb. Heavy Duty Engine Crane

SKU 1267948 **1,399<sup>99</sup>**  
AFF3584

- Reinforced Leg Assemblies for Added Strength and Durability
- 4 Different Boom Settings: 3, 2, 1.5 and 1 Ton
- Rear of Crane: 61.5" Tall x 33" Wide
- Distance Between Front of Legs: Retracted 23", Extended 28.5"
- Built-In Safety Overload to Protect the Unit from Being Used Beyond its Rated Capacity



### 2 Ton Folding Shop Crane

SKU OUTSIDE BUY/EPO  
RANRSC2TF

**699<sup>99</sup>**

- Heavy Duty Hydraulic Folding Engine Hoist with 2 Ton Capacity Ram is Perfect for Shops That Have Limited Space but Still Need the Pure Lifting Convenience of a Crane
- Front Casters Include a Safety Brake to Prevent Movement



For Outside Buy/EPO, Call 901-300-4878

### 2 Ton Folding Shop Crane

SKU 544801  
24830

**499<sup>99</sup>**

- Foldable Design Makes for Convenient, Easy Storage
- 6 Solid Steel Caster Wheels Add Mobility
- Fully Adjustable 4 Position Boom



OEM TOOLS®

## Lift Accessories

### Universal Engine Lift Plate 1,000 Lb. Capacity

SKU 662861 **15<sup>99</sup>**  
24867

- Corrosion Resistant, Gold Iridite Zinc Plating
- Tough, All Steel Construction
- Fits Most V Style 6 and 8 Cylinder Engines with 2 or 4 Barrel Intake Manifolds
- Mounting Hardware Not Included



OEM TOOLS®

### Floor Jack Crossbeam

SKU 544803 **99<sup>99</sup>**  
24833

- Compatible with Most Floor Jacks with a 1-1/8" Diameter Saddle Stud
- Saddles Adjust from 23" to 32" on Center
- Min. Width Capacity: 3,000 Lb.
- Max. Width Capacity: 4,000 Lb.



OEM TOOLS®

### Bed Lifter

SKU OUTSIDE BUY/EPO **329<sup>99</sup>**  
STK35885

- Designed to Lift Truck Beds Safely and Easily
- Lifting Brackets Adjusts to Evenly Distribute Weight



Price does not include vehicle

STECK

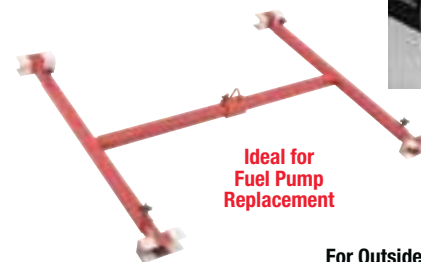

Ideal for Fuel Pump Replacement

For Outside Buy/EPO, Call 901-300-4878

# JACKS & HYDRAULICS

TO ORDER, contact your Commercial Sales Manager or go to [AutoZonePro.com](http://AutoZonePro.com)

JACKS & HYDRAULICS

## Engine Support

### 3 Point Engine Support Bar

SKU 133617 **99<sup>99</sup>**  
24951

- Makes Removal of Transaxle Easy by Supporting Engine of Front Wheel Drive Vehicles
- Width Expands from 34-1/2" to 61"
- (2) 14" Adjustable Hook Screws
- (2) 38" Braided Steel Cables
- 700 Lb. Capacity



### 1,100 Lb. Engine Support

SKU 512946 **149<sup>99</sup>**  
24950

- 2 Screw Adjusters for Precise Positioning Makes Job Easier, Faster and Safer
- Rubber Feet to Prevent Damage to Vehicle and Ensure Stability
- 1,100 Lb. Capacity



### 3/4 Ton Engine Leveler

SKU 544802 **49<sup>99</sup>**  
24831

- 4 Point Mounting System Provides Maximum Control
- 3 Chain Positions to Accommodate Different Engine Configurations
- Durable Steel Construction
- Smooth Operating Worm Drive Shaft for Easy Level Adjustment
- Rated Capacity: 1,500 Lb.

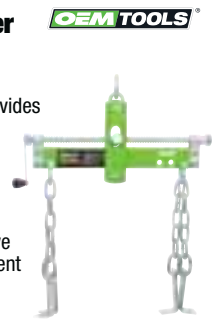

## Lift Table

OEM TOOLS®

### 660 Lb. Double-Scissor Lifting Table Cart

SKU 1525568 **699<sup>99</sup>**  
24789

**NEW**

- Reduces Operator Strain When Moving Heavy or Bulky Items
- Double Scissor Mechanism Raises the Table from 13.8" to 50.6"
- Large 32" x 20" Platform Fits a Wide Range of Items
- Foot Pedal Pump Allows Hands-Free Operation
- Hand Operated Release Lever for Easy, Controlled Descent
- 5" Heavy Duty Casters with Bearings for Easy Rolling Over Rough Floors
- Safety Bar Lock Mechanism Allows the Table to Be Secured at 40.2"
- All Steel Construction for Strength and Durability



## High Reach Stands

OEM TOOLS®

- Provides Added Support During Installation/Removal of Automotive Components
- Compact Design for Use in Limited Workspaces
- Durable Heavy Gauge Steel Construction

### 1,500 Lb. High Reach Jack Stand

SKU 757043 **119<sup>99</sup>**  
24848

- Min. Height: 55"
- Max. Height: 78"
- Meets or Exceeds ASME PASE-2019 Standards



### 1,500 Lb. High Reach Jack Stand with Foot Pedal

SKU 757078 **149<sup>99</sup>**  
24847

- Foot Pedal Pump Saves Time Adjusting Load
- Min. Height: 55"
- Max. Height: 78"
- Meets or Exceeds ASME PASE-2019 Standards



### 2 Ton Underhoist Tripod Jack Stand

SKU 757084 **179<sup>99</sup>**  
24849

- Adjustment Pin Securely Supports Load in 5 Positions
- Min. Height: 49"
- Max. Height: 80"
- Meets or Exceeds ASME PASE-2019 Standards



## Powertrain Lifts

GL Challenger Lifts

### EV Lift Table

SKU OUTSIDE BUY/EPO **10,199<sup>99</sup>**  
CHLBT3300

- 3,300 Lb. Lift Capacity
- Scissor-Style Lifting
- Hydraulic Cylinder and 115V Plug
- Pendant Controlled Operation
- Max. Reachable Height: 76.5"
- Complies with ASME PASE-2019
- 8" Clearance Under Base Plate for Battery Removal
- Extending, Adjusting and Tilting Top Plate for Larger Batteries



### 2,200 Lb. Lifting Table, Air/Hydraulic with Adapters

SKU OUTSIDE BUY/EPO **3,999<sup>99</sup>**  
CEA-MS10KIT

- Designed for Removing/Replacing Battery Packs of Electric Vehicles as well as the Engine, Transmission, Drive Axle, Fuel Tank, Suspension and Sub-Frames of Traditional Vehicles
- Large Base Frame Ensures Better Stability and Reliability
- Max. Lift: 70-1/16"
- Min. Height: 22-7/16"
- Platform Length: 51-3/8" to 58-1/4"
- Platform Width: 33-1/8"



### 2,640 Lb. Lifting Table, Electric/Hydraulic with Adapters

SKU OUTSIDE BUY/EPO **6,499<sup>99</sup>**  
CEA-MS12MKIT

CUTTING EDGE

### 2,500 Lb. Powertrain Lift

SKU OUTSIDE BUY/EPO **5,099<sup>99</sup>**  
AFF3182

- Air Assist Foot Pump with 9' Extension Provides Hands-Free Operation
- Safety Latches at 30%, 50% and 80% of Max. Height
- 8" Diameter Swivel Casters for Easy Maneuverability
- Rear Wheels Can Be Locked to Prevent Rolling
- Table Top Height from 33" to 77"



### 4,500 Lb. BendPak. EV Battery and Powertrain Lift Table

SKU OUTSIDE BUY/EPO **11,649<sup>99</sup>**  
BENEVS4500

- Full-Rise Battery Powered Mobile Scissor Lift Table
- Remote Control Operation
- DC Electric Power System with Onboard Charging
- Full-Length Utility Trays



To Confirm Price, Availability and Ordering Instructions on Outside Buy/EPO, Call 901-300-4878

Prices subject to change without notice. Prices do not include applicable taxes, vehicles, tires, rims, installation or optional equipment as shown. Please do not return purchases to the store. For information regarding warranty, repair, or any questions or concerns, call 901-300-4878.

AZG0225

85

# ALIGNMENT

Ask About Special Pricing on Additional Multi-Lifts and Package Deals, Call 901-300-4878

## SAVE OVER \$2,049

### Hofmann Geoliner® 609 with 12K 4-Post Lift

SKU **OUTSIDE BUY/EPO** **ALIGNCOMB020** **30,499<sup>99</sup>**

- Provides Accurate, Real-time Measurements - Reduces Setup and Measurement Times While Generating Serious Productivity Benefits
- Ultra Low-Profile Design Allows Easy-On Approach Angle for Low Profile Vehicles
- Hydraulic Cylinder Mounted Underneath Runway
- Closed Front Design

**\*Hofmann Will Pay \$750 Towards Your Lift Install.**

(Must use Hofmann authorized installer.)

**ALIGNER INCLUDES:**  
Manufacturer's Set-Up

**INCLUDES:** 2 Rolling Jacks, Air Line Kit, Turn Plates and Rollback Kit



HOFEEWA741TH3



Offer Good Through June 30, 2025



HOFEELR728APKG	12K 4 Post Alignment Lift	\$17,399.99
HOFEEWA741TH3	Geoliner® 609 Alignment System	\$14,399.99
	<b>Regular Price</b>	<b>\$31,799.98</b>
<b>ALIGNCOMB020</b>	<b>COMBO PRICE</b>	<b>\$30,499.99</b>
	<b>SAVINGS</b>	<b>\$1,299.99</b>
	<b>\$750 TOWARDS LIFT INSTALL*</b>	<b>\$750.00</b>
	<b>TOTAL SAVINGS</b>	<b>\$2,049.99</b>



HOFEELR728APKG

WARRANTY: 1 Year Parts and Labor

## SAVE OVER \$3,799

### Hofmann Geoliner 678 Complete Alignment System with 12,000 Lb. Scissor Lift

SKU **OUTSIDE BUY/EPO** **ALIGNCOMB026** **51,999<sup>99</sup>**

- Includes: Geoliner® 678 Aligner w/AC400 Clamps and VIN Reader, 12,000 Lb. Scissor Lift with (2) Rolling Jacks, Air Line Kit, Turn Plates and Rollback Kit
- Open Front Design Provides Easy Access to Alignment Service and Calibration Areas
- 24" Wide Runways Provide Easy Drive-On for Large Vehicles
- 70" Lifting Height

**\*Hofmann Will Pay \$1,500 Towards Your Lift Install.**

(Must use Hofmann authorized installer.)

**ALIGNER INCLUDES:**  
Manufacturer's Set-Up

**INCLUDES:** (2) Rolling Jacks, Air Line Kit, Premium Turn Plates and Rollback Kit

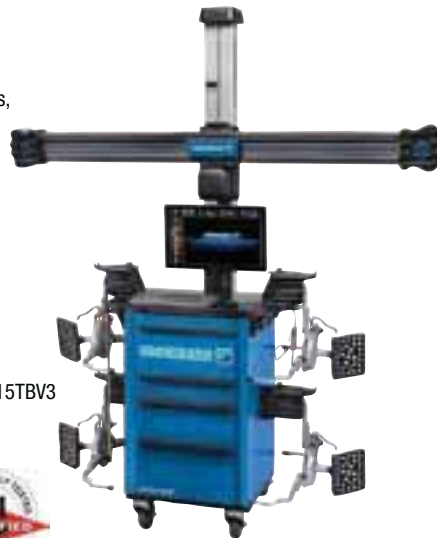

HOFA715TBV3



WARRANTY: 1 Year Parts and Labor

Offer Good Through June 30, 2025



HOFR709APKG	12K Scissor Alignment Lift	\$26,199.99
HOFA715TBV3	GEOLINER 678 AC400 & VIN	\$28,099.99
	<b>Regular Price</b>	<b>\$54,299.98</b>
<b>ALIGNCOMB026</b>	<b>COMBO PRICE</b>	<b>\$51,999.99</b>
	<b>SAVINGS</b>	<b>\$2,299.99</b>
	<b>\$1,500 TOWARDS LIFT INSTALL*</b>	<b>\$1,500.00</b>
	<b>TOTAL SAVINGS</b>	<b>\$3,799.99</b>



HOFR709APKG



Customer Responsible For Offloading, Liftgate Service Available.

For Outside Buy/EPO, Call 901-300-4878

- Free Delivery in 48 Continental United States
- Specifications Subject to Change without Notice or Liability
- Equipment Lead Times and Shipping May Vary
- Customers Responsible for Offloading Equipment Upon Arrival
- Leasing Terms Available, Ask Your AutoZone® Commercial Sales Manager.

Prices subject to change without notice. Prices do not include applicable taxes, vehicles, tires, rims, installation or optional equipment as shown. Please do not return purchases to the store. For information regarding warranty, repair, or any questions or concerns, call 901-300-4878.

## Aligners

### Geoliner® 770 AC400 Clamps and VIN Reader

SKU OUTSIDE BUY/EPO **30,699<sup>99</sup>**  
HOFEEWA752BV3

- Lightweight, 3-Camera System Folds to a Compact Size with a Low Center of Gravity, Taking Up Less Floor Space in the Shop and Easily Maneuverable When Needed
- Touchless AC400 Wheel Clamping System (Only the Tire is Contacted), Installed in Seconds with a Single, Fast-Action Adjustment Knob
- Automatic Height Tracking to Provide Optimum Placement of its Advanced XD Targets and Cameras for More Speed and More Accuracy on Every Alignment
- Diagnostic Alignment with "Compensate Warn Alert" Intervention Gets it Right the First Time
- Video Speed Cameras Constantly Monitor Alignments, Providing Information at Every Step
- Unique Camera Beam Design Fits Through a Standard Doorway and Protects Cameras
- Next Generation UI Optimized for the High Volume User
- Highly Accurate and Reliable XD Camera Technology



**HOFMANN**

### Geoliner® 609 Alignment System

SKU OUTSIDE BUY/EPO  
HOFEEWA741TH3

**14,399<sup>99</sup>**

- Groundbreaking User Interface Provides Instant Access to Critical Tasks
- No Calibrations Required
- Designed for a Connected World
- Small Footprint
- Includes:  
AC200 Clamps

**WARRANTY:**  
1 Year Motor and Parts,  
6 Months Labor,  
3 Years Circuit Boards,  
Pods and Electronics

**ALIGNER INCLUDES:**  
Manufacturer's Set-Up



**ALIGNER INCLUDES:**  
Manufacturer's Set-Up

**WARRANTY:**  
1 Year Motor and Parts, 6 Months Labor,  
3 Years Circuit Boards, Pods and Electronics

### Geoliner® 660 Imaging Wheel Aligner

SKU OUTSIDE BUY/EPO **22,499<sup>99</sup>**  
HOFEEWA712TH3

- Advanced XD Cameras and Sophisticated Monitoring Algorithms
- Exclusive Dimensioning and Productivity Features
- Patented EZ-TOE – Turn the Front Wheels and Access Difficult Adjustment Points While Still Displaying Centered Toe Readings
- Features Easy-Rolling Casters, Storage for All Attachments and a Fully Enclosed Printer Compartment
- Includes AC200 Clamps, Brake Pedal Depressor, Color Ink-Jet Printer and Steering Wheel Holder



### Geoliner® 678 Wheel Alignment System with AC400 and VIN

SKU OUTSIDE BUY/EPO **28,099<sup>99</sup>**  
HOFA715TBV3

- Easy to Use Interface - 3 Levels of Intervention ("Compensate – Warn – Alert") with Corrective Actions Just One Click Away
- Help Videos - View Detailed Videos of How to Make Needed Adjustments to Complete Even the Most Complex Tasks
- Cross-Diagonal Measurements Identify Frame or Structural Damage (Saving Time)
- Rolling Radius Identifies Mismatched Tire Sizes to Prevent Vehicle Pulling and Drive Train Damage
- Touchless AC400 Wheel Clamping System (Only the Tire is Contacted), Installed in Seconds with a Single Fast-Action Adjustment Knob

**WARRANTY:**  
1 Year Motor and Parts, 6 Months Labor,  
3 Years Circuit Boards, Pods and Electronics

**ALIGNER INCLUDES:**  
Manufacturer's Set-Up



**WARRANTY:**  
1 Year Motor and Parts, 6 Months Labor,  
3 Years Circuit Boards, Pods and Electronics

**ALIGNER INCLUDES:**  
Manufacturer's Set-Up

## Alignment Accessories

### Steel Turn Plates

SKU OUTSIDE BUY/EPO  
QSP25-140

- Call for Price**
- Capacity: 4,500 Lb. per Plate
  - Dimensions: 14" x 14" x 1.5"



### Stainless Steel Turn Plates

SKU OUTSIDE BUY/EPO  
QSP25-129

**Call for Price**



### Rear Slip Plate Add-On Kit

SKU OUTSIDE BUY/EPO  
QSPDB-6000

**Call for Price**

- (2) 59-1/2" x 20" Full Floating Rear Slip Plates
- Simple Installation On Most General Service Lifts
- Length Options: 173", 186" to 196" and 200" to 205"
- Turn Plates Not Included



### Steering Wheel Holder and Pedal Depressor Kit

SKU 802195 **64<sup>99</sup>**  
24231

- Holds Steering Wheel in Position for Alignment Adjustments
- Depresses Brake Pedal for Various Brake Checks Including Brake Lamp Operation
- Simply Hand Squeeze the Actuator to Accomplish Fine Adjustments

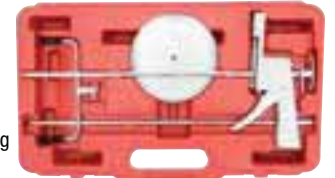

Customer Responsible For Offloading, Liftgate Service Available.

For Outside Buy/EPO, Call 901-300-4878

- Free Delivery in 48 Continental United States
- Specifications Subject to Change without Notice or Liability
- Equipment Lead Times and Shipping May Vary
- Customers Responsible for Offloading Equipment Upon Arrival
- Leasing Terms Available, Ask Your AutoZone® Commercial Sales Manager.

Prices subject to change without notice. Prices do not include applicable taxes, vehicles, tires, rims, installation or optional equipment as shown. Please do not return purchases to the store. For information regarding warranty, repair, or any questions or concerns, call 901-300-4878.

# ALIGNMENT

## Aligners

### CWA 6500 Wheel Aligner

SKU OUTSIDE BUY/EPO  
AMM8006500

**25,599<sup>99</sup>**

- Comes with Both Self-Centering Clamp and Exclusive Tire Gripping Adapters to Ensure Both Accurate Reading and Fast Operation
- Multiple Compensation Modes to Make Getting Readings on Heavy Vehicles Easy without Having to Roll Vehicle Excessively Far
- Two Wheel Alignment Mode for Setting Total Tow on Large Trucks, No Rear Targets Required
- Standard VIN Scanner for Time Savings and Ease of Vehicle Selection
- Mobile Cabinet Supports Using Aligner in Multiple Bays



**COALS**

**ALIGNER INCLUDES:**  
Manufacturer's Set-Up and Training

**WARRANTY:**  
1 Year Parts,  
6 Months Labor, 30 Days Wheel Clamps

### Portable 3D Wheel Alignment System

SKU OUTSIDE BUY/EPO  
ROTR1085

**23,299<sup>99</sup>**

- Mobile Tablet Operation
- Wi-Fi Ready
- Easy-to-Use Software
- Tower-Free System
- On Rack Test Drive Program
- Easy-to-Read Results
- Quick Locking Wheel Clamps
- Patented Targets
- Fixed Cameras



**ALIGNER INCLUDES:**  
Manufacturer's Set-Up

**WARRANTY:**  
3 Years Parts and  
1 Year Labor

### CEMB Wheel Alignment Systems

- User Friendly Software with Adjustment Graphics
- More Than 55,000 Vehicles In Database
- Cloud Based Wi-Fi Networking
- 12" to 24.5" Clamping Range
- For Cars and Light Trucks



### Trolley Wheel Alignment System

**NEW**

SKU OUTSIDE BUY/EPO  
CMBDWA1100TROLL

**11,899<sup>99</sup>**

**SAVE \$1,150**

REG. \$13,049.99

- Toughpad with 10" Touch Screen, Waterproof, Dustproof Rubberized Case



CMBDWA1100TROLL

### Complete Wheel Alignment System

SKU OUTSIDE BUY/EPO  
CMBDWA1100CWAS

**16,899<sup>99</sup>**

**SAVE \$2,000**

REG. \$18,899.99

- Portable Wheel Stands with Integral Turn Plates on All Four Stands Align All Vehicles
- Stands Weight Limit: 10,000 Lb. or 2,500 Lb. per Stand
- Includes: Stands, Roller and Plates

**ALIGNER INCLUDES:**  
Manufacturer's Set-Up and Training

**WARRANTY:**  
2 Years Parts, 1 Year Labor

Offers Good Through June 30, 2025

### DWA3500 3D High Definition Wheel Alignment System

SKU OUTSIDE BUY/EPO  
CMBDWA3500

**18,999<sup>99</sup>**

**SAVE \$1,150**

REG. \$20,149.99

- 3D HD Camera Technology
- Portable Cabinet/Tower Moves Bay-to-Bay
- Adjustable Camera Height Follows Alignment Rack
- Complete 4-Wheel Alignment System
- Includes: 24" Monitor, Color Printer, Compact Wheel Targets and User-Friendly Software
- FREE 1-Year Spec Update and Shop Alignment Banner

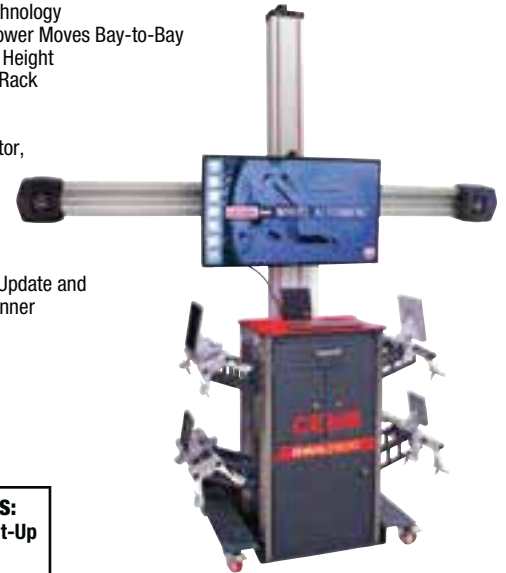

**ALIGNER INCLUDES:**  
Manufacturer's Set-Up and Training

**WARRANTY:** 2 Years Parts, 1 Year Labor

Offer Good Through June 30, 2025



Customer Responsible For Offloading, Liftgate Service Available.

For Outside Buy/EPO, Call 901-300-4878

- Free Delivery in 48 Continental United States
- Specifications Subject to Change without Notice or Liability
- Equipment Lead Times and Shipping May Vary
- Customers Responsible for Offloading Equipment Upon Arrival
- Leasing Terms Available, Ask Your AutoZone® Commercial Sales Manager.



## Alignment Lifts

**HOFMANN**

### 12,000 Lb. Scissor Alignment Lift

SKU OUTSIDE BUY/EPO  
HOFR709APKG

**26,199<sup>99</sup>**

- Open Front Design Provides Easy Access to Alignment Service and Calibration Areas
- 24" Wide Runways Provide Easy Drive-On for Large Vehicles
- Dual Engaging Twin Interlocking Mechanical Safety Racks with Pneumatic Release
- 95 Second Lifting Time and 45 Second Lowering Time
- 70" Lifting Height



**INCLUDES:** Rolling Bridge Jacks, Air Line Kit and Turn Plates

**WARRANTY:**  
1 Year Parts and Labor

### 15,000 Lb. 4 Post Open Front Alignment Rack Package - Ext. Length

SKU OUTSIDE BUY/EPO  
CHLAR4115XAO

**30,549<sup>99</sup>**

**CL Challenger Lifts**

- Max. Wheelbase: 210"
- Improved 4-Wheel Alignment Wheelbase with Longer Rear Slip Plates
- Removable Lock without Dropping the Column
- Enclosed Column with No Outside Lubrication
- Improved Column and Cross Beam Design
- Increased Drive Through Clearance
- 26" Wide Runways
- 78" Rise Height



**WARRANTY:**  
2 Year Parts, 1 Year Labor

**INCLUDES:** Air Line Kit, Slip Plates, Turn Plates and Two Rolling Jacks

### 14,000 Lb. Scissor Alignment Lift Package

SKU OUTSIDE BUY/EPO  
AMM8KSC14KITP

**42,999<sup>99</sup>**

**coats**

- Max. Service Wheelbase: 198"
- Max. 4 Wheel Alignment Wheelbase: 160"
- Max. 2 Wheel Alignment Wheelbase: 178"
- Ceiling Height Required: 12'
- Overall Length: 260"
- Overall Width: 91-1/2"
- Lifting Height: 74"



**INCLUDES:** 2 HD Rolling Jacks, 2 SS Turn Plates, 2 Roll Back Bars and 1 Airline Kit

**WARRANTY:**  
1 Year Parts and  
6 Months Labor

### 14,000 Lb. 4 Post Alignment Lift

SKU OUTSIDE BUY/EPO  
FORCRA14

**22,899<sup>99</sup>**

**FORWARD**

- Max. Rise: 80-3/4"
- Max. Wheelbase: 182-1/2"
- 4 Wheel Alignment from 88" to 157"
- Long Lasting, High Performance Cable and Sheave System



**INCLUDES:** Rear Slip Plates, (2) 7,000 Lb. Rolling Jacks, Radius Gauges and Internal Air Line

**WARRANTY:**  
1 Year Parts and Labor

### 4 Post Alignment Lift Combo

SKU OUTSIDE BUY/EPO  
BEN14LSXCOMB1

**16,899<sup>99</sup>**

**BendPak**

- 14,000 Lb. Capacity
- Overall Length: 241"
- Runway Width: 20"



**WARRANTY:**  
1 Year Parts and Labor

**INCLUDES:** Air Line Kit, Slip Plates, Turn Plates and Two Rolling Jacks

### 15,000 Lb. 4 Post Open Front Ext. Alignment Lift Pkg

SKU OUTSIDE BUY/EPO  
AMM8K4P15XKITP

**37,549<sup>99</sup>**

**coats**

- Max. 4 Wheel Alignment Wheelbase: 164-1/2"
- Max. 2 Wheel Alignment Wheelbase: 209"
- Ceiling Height Required: 12'
- Raised Height: 75"
- Overall Length: 287-1/2"
- Overall Width: Front 143" to Rear 137-1/2"



**INCLUDES:** 2 HD Rolling Jacks, 2 SS Turn Plates, 2 Roll Back Bars and 1 Airline Kit

**WARRANTY:**  
1 Year Parts and  
6 Months Labor



Customer Responsible For Offloading.

For Outside Buy/EPO, Call 901-300-4878

- Free Delivery in 48 Continental United States
- Specifications Subject to Change without Notice or Liability
- Equipment Lead Times and Shipping May Vary
- Customers Responsible for Offloading Equipment Upon Arrival
- Leasing Terms Available, Ask Your AutoZone® Commercial Sales Manager.

Prices subject to change without notice. Prices do not include applicable taxes, vehicles, tires, rims, installation or optional equipment as shown. Please do not return purchases to the store. For information regarding warranty, repair, or any questions or concerns, call 901-300-4878.

## Four Post Lifts

**28,999<sup>99</sup>**

### CK-14KACX-IWA

iDEAL Alignment Lift & Wheel Aligner Combo Bundle Kit

SKU: 1429041

- High Performance Commercial Alignment Lift
- Durable, High Quality Cable Lift System
- Extended Rise Height
- 'Bolt-On' Runway Alignment Kit
- 18 Locking Height Positions
- 20" Wide Runways
- Slack Cable Safety Devices
- Self-Chocking Approach Ramps W/ Nylon Rollers
- Wide Scope High Resolution 3D Industrial Grade Cameras
- .01 Degrees Alignment Accuracy
- Wireless Internet Support



Combo Bundle Kit = (1) FP14KAC-X Alignment Lift  
(2) RAJ-7K-H Bridge Jacks & (1) IWA-60-2000T-K 3D iPRO Wheel Aligner

## Two Post Lifts

**4,799<sup>99</sup>**

### IDEAL - TP10KAC-DX

10,000lbs CAPACITY  
SKU 942096

- ALI Certified
- Bi-symmetric Arms
- Overall Height: 144"
- Overall Width: 145-1/2"
- Bi-Symmetric Lift Arms
- Low Profile Swing Arm Design
- 3 Stage Front Arms
- Adjustable Height Swivel Pads
- Stackable Height Adapters



Price Does Not Include Vehicle, Installation or Optional Equipment as Shown

## Lift Tables

**5,999<sup>99</sup>**

### LT-PT2500AH-X

2,500lbs CAPACITY

SKU 1410263

- Provides Safe & Efficient Method to Remove & Install Heavy Powertrain
- Innovative, High Quality Portable Scissor Lift Design
- Full Operation Air System Hand Controls



## Storage Lifts

**4,624<sup>99</sup>**

### FP8K-DX-XLT

8,000lbs CAPACITY

SKU 426415

- Extended Lift Height & Length
- Cable Driven Lifting System
- Single Point Manual Lock Release
- Slack Cable Safety
- Steel Approach Ramps
- Adjustable Locking Positions
- Fits in Large Residential Garages



**4,529<sup>99</sup>**

### TP11KC-DX

11,000lbs CAPACITY

SKU 426140

- Direct "Pull" Cylinders
- Overall Height: 145"
- Overall Width: 145-1/2"
- 3 Stage Front Arms,
- Low Profile Arms
- Rubber Door Guards
- Spin Up Pads with stackable drop in Height Adapters



BI-SYMMETRIC™ DESIGN  
Asymmetric/Symmetric arm configuration with 180 degree front arm rotation.

**7,099<sup>99</sup>**

### LT-PT3300DC-X

3,300lbs CAPACITY

SKU 1412412

- Provides Safe & Efficient Method To Remove & Install Heavy Powertrain Component
- Innovative, High Quality Portable Scissor Lift Design
- Full Electrical Operation
- 12vdc Battery Operation W/ Integrated 110v Battery Charger



## Scissor Lifts

**4,299<sup>99</sup>**

### LR-10K-TLPAD

10,000lbs CAPACITY

SKU 1404546

- Ideal For Express Tire & Wheel Service
- Surface Mount Install Configuration
- Integrated Outer Frame & Ramps Provide Drive-On & Off Clearance For Wide Vehicles
- Latch Release Handles On Each Side Of Lift



**3,024<sup>99</sup>**

### TP9KACX

9,000lbs CAPACITY

SKU 426138

- Asymmetric Arms
- Overall Height: 143"
- Overall Width: 138"
- Spin Up Pads with stackable drop-in height adapters



## Wheel Service

### TC-950

Semi-Automatic Tire Changer

SKU 426755

- Max Wheel Diameter: 47"
- Rim Width: 3" - 15"
- Rim Diameter: 15" - 28"

**2,569<sup>99</sup>**



## Single Post

**4,899<sup>99</sup>**

### SC-2K-UTV-X

iDEAL Single Column, UTV & Mower Storage/ Service Lift

SKU 1413367

- 2,000 lbs Capacity
- Multi-Purpose Single Column Dual Platform Lift Design
- Ideal Storage Solution for Most Small to Mid-Sized ATVs, UTVs, Golf Carts, Riding Lawnmowers & Zero Turns



Price Does Not Include Vehicle, Installation or Optional Equipment as Shown

**2,949<sup>99</sup>**

### TP9KFX

9,000lbs CAPACITY

SKU 426106

- Symmetric Arms
- Overall Height: 112"
- Overall Width: 134.5"
- Spin Up Pads with Stackable drop-in height adapters



## DON'T FORGET THESE ACCESSORIES!



### PWB-1600

1,600 lbs Workbench  
SKU 1284169

**569<sup>99</sup>**



### SJ-35

Sliding Jack  
SKU 426447

**1199<sup>99</sup>**



### 8G DRAIN

8 Gallon Drain  
SKU 426733

**179<sup>99</sup>**

# AUTOMOTIVE LIFTS

FOR HELP with Selection, Confirm Availability and Ordering Instructions, Call 901-300-4878

AUTOMOTIVE LIFTS

## Coats Lifts

### 10,000 Lb. 2 Post Lift with 3 Stage 2n1 Arms

SKU OUTSIDE BUY/EPO AMM4TV21NSR1

**6,649<sup>99</sup>**

- 90° Offset 3-Stage Front and Rear Arms for Asymmetric or Symmetric Vehicle Positioning
- Includes Door Bumper Guards and Lifting Adapters
- Premium U.S. Made Power Unit
- Overall Height: 138" or 148"



WARRANTY: 1 Year Parts, 6 Months Labor

### 12,000 Lb. 2 Post Lift with 3 Stage Symmetric Straight Arms

SKU OUTSIDE BUY/EPO AMM4T212SSR1

**10,249<sup>99</sup>**

- Includes: Door Bumper Guards and Lifting Adapters
- Overall Width: 137-1/8"
- Overall Height: 154-7/8" or 158-7/8"
- Color: Red



### 12,000 Lb. 2 Post Lift with 3 Stage 2n1 Arms

SKU OUTSIDE BUY/EPO AMM4T212NSR1

**10,249<sup>99</sup>**

WARRANTY: 1 Year Parts, 6 Months Labor

**COATS**



**BEFORE PLACING YOUR AUTOMOTIVE LIFT ORDER:**

Please verify minimum ceiling height, concrete requirements and bay size. See page 2 for delivery information or Call 901-300-4878.

## Challenger Lifts

### 10,000 Lb. 2 Post New Offset Arm Design Lift

SKU OUTSIDE BUY/EPO CHLVLE10

**5,399<sup>99</sup>**

- Versymmetric 3-Stage Offset Front Arms
- Lifts Versymmetric
- Rubber Door Guards
- Color: Red or Blue



Versymmetric Technology

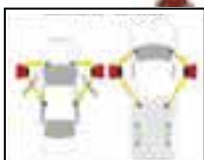

INCLUDES: Telescoping Footpads

WARRANTY: 1 Year Parts and Labor

### 10,000 Lb. 2-Post Versymmetric® Adjustable Lift

SKU OUTSIDE BUY/EPO CHLCL10AV3

**7,499<sup>99</sup>**

- Versymmetric 3-Stage Front, 3-Stage Rear Arms with Swept Arm Design
- Adjustable Height and Width
- 3 Adjustable Widths and 2 Adjustable Heights
- Can Be Set Up to Lift Most EVs
- Arm Reach: Front - Min. 20", Max. 42"
- Rear - Min. 37-5/8", Max. 60"
- Height: 12' Minimum
- Width: 14' Recommended
- Power: 208-230V, 1pH, 30 Amps



CL Challenger Lifts

Versymmetric Technology

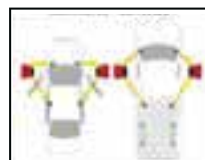

INCLUDES: Telescoping Footpads

WARRANTY: 2 Years Parts and 1 Year Labor

## Quality Lifts

quality lifts

### 10,000 Lb. 2 Post Lift

SKU OUTSIDE BUY/EPO CHLEQ10

**4,959<sup>99</sup>**

- 3-Stage Front, 2-Stage Rear Arms
- Lifts Symmetrically or Asymmetrically
- Ceiling Height Required: 12'
- Rubber Door Guards
- Color: Black Only



INCLUDES: (4) 3" Stack Adapters

WARRANTY: 6 Months Parts and Labor

## UPGRADE YOUR QUALITY LIFT

### Double Telescoping Foot Pads (4 Pack)

SKU OUTSIDE BUY/EPO CHLB2270PK4

**464<sup>99</sup>**

- 10,000 Lb. Footpads
- Fits Quality 10,000 Lb. 2 Post Lifts
- Single Pad Features Frame Engaging Ears



### (2) 6" Stack Adapters

SKU OUTSIDE BUY/EPO CHL10313

**169<sup>99</sup>**

- Upgrade for CHLEQ10 Lift



### 12,000 Lb. 2 Post Heavy Duty Lift Screw-Style Footpad

SKU OUTSIDE BUY/EPO CHLB12162S-12

**89<sup>99</sup>**

- Fits Challenger and Quality 12,000 Lb. Heavy Duty 2 Post Lifts
- Single Pad Features Frame Engaging Ears



### 14,000 Lb. 4 Post Lift

SKU OUTSIDE BUY/EPO CHL4P14EFX

**9,049<sup>99</sup>**

- 20" Wide Runways
- 182.5" Wheelbase
- Minimum Bay Size: 12' x 24'
- Rise Height: 78"



### Air Line Kit

SKU OUTSIDE BUY/EPO CHL40230E

**559<sup>99</sup>**

WARRANTY: 1 Year Parts and Labor  
Rolling Jacks Sold Separately

### One 7,500 Lb. Rolling Jack

SKU OUTSIDE BUY/EPO CHLRJ75

**2,999<sup>99</sup>**



Optional Equipment

WORKS WITH



Customer Responsible For Offloading.

For Outside Buy/EPO, Call 901-300-4878

- Free Delivery in 48 Continental United States
- Specifications Subject to Change without Notice or Liability
- Equipment Lead Times and Shipping May Vary
- Customers Responsible for Offloading Equipment Upon Arrival
- Leasing Terms Available, Ask Your AutoZone® Commercial Sales Manager.

Prices subject to change without notice. Prices do not include applicable taxes, vehicles, tires, rims, installation or optional equipment as shown. Please do not return purchases to the store. For information regarding warranty, repair, or any questions or concerns, call 901-300-4878.

AZG0225

# AUTOMOTIVE LIFTS

## Forward Lifts

### 10,000 Lb. I10 2 Post Lift

SKU OUTSIDE BUY/EPO FORI10

**5,799<sup>99</sup>**

- Smooth Lifting and Long Life with Forward's Direct Pull Cylinders
- Spot-Rite™ 3-Stage Front Arms
- 76-1/4" Rise
- Low Profile Oversized Pad with 3.5" and 5" Extensions

**INCLUDES:**  
Truck Adapters

**WARRANTY:**  
1 Year Parts and Labor

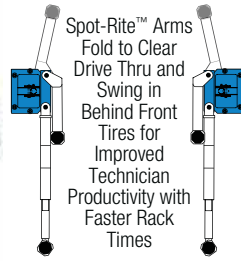

Spot-Rite™ Arms Fold to Clear Drive Thru and Swing in Behind Front Tires for Improved Technician Productivity with Faster Rack Times



### 12,000 Lb. I12 2 Post Lift

SKU OUTSIDE BUY/EPO FORI12N300BL

**10,799<sup>99</sup>**

- 4 Robust 3-Stage Arms with Reach Range from 27-3/4" to 59"
- Includes: 1-3/4", 3-1/2" and 5" Adapter Extenders
- Low Profile 4-3/4" Adapter
- Min. Ceiling Height: 167"
- 77-1/2" Rise

**INCLUDES:**  
Truck Adapters

**WARRANTY:**  
1 Year Parts and Labor



Height Configurations of 11'-10", 12'-10" and 14'-10" are Available at No Extra Charge

3-Stage Front and Rear Arms



### 15,000 Lb. DP15N001BL 2 Post Lift - Blue

SKU OUTSIDE BUY/EPO FORDP15N001BL

**15,099<sup>99</sup>**

- 175" Tall
- Single Point Lock Release Design
- Direct Pull Lifting - Smooth Operating, Low Maintenance Technology

**INCLUDES:**  
Truck Adapters

**WARRANTY:**  
1 Year Parts and Labor



### 14,000 Lb. CR14L 4 Post Lift

SKU OUTSIDE BUY/EPO FORCR14L

**10,049<sup>99</sup>**

- Heavy Duty Hydraulic Cylinder
- Single Point Latch Release System
- 78-3/4" Rise
- 18 Lock Positions
- Accommodates 182-1/2" Wheelbase Vehicles
- High Performance Cable and Sheave System

### Internal Air Line Kit

SKU OUTSIDE BUY/EPO ROTFC5760-14

**784<sup>99</sup>**

Optional Equipment



**WARRANTY:**  
1 Year Parts and Labor

Rolling Jacks Sold Separately



## WORKS WITH

### One 7,000 Lb. Rolling Jack

SKU OUTSIDE BUY/EPO FORRRJ70G

**4,049<sup>99</sup>**

Optional Equipment

### Two 7,000 Lb. Rolling Jacks

SKU OUTSIDE BUY/EPO FORRRJ70GBOGO

**6,099<sup>99</sup>**

Optional Equipment



Offer Valid Only with Purchase of Forward 4 Post Lift

## Rotary Lifts

### 10,000 Lb. 2-Post Asymmetric Lift with AV Arms - Blue

SKU OUTSIDE BUY/EPO ROTSPA10AVBL

**8,599<sup>99</sup>**

- Easy Spotting and Positioning
- Highest Capacity Low-Profile Lift Available
- Comes Standard with Adjustable Round, Truck and Stackable Adapter Extensions
- Overall Width: 11' 5-1/2"
- Overall Height: 11' 11-1/2"
- Arm Reach: Front: Min. 18-1/2" - Max. 41", Rear: Min. 27-5/8" - Max. 58-1/4"
- Max Rise: 81-1/2"
- Drive-Thru Clearance: 95-1/4"
- Min. Bay Size: 12' x 24'

**WARRANTY:** 1 Year Parts and Labor



Shown with Additional Accessories

### 12,000 Lb. 2 Post Lift

SKU OUTSIDE BUY/EPO ROTSP012

**12,249<sup>99</sup>**

- 3 Stage Front and Rear Arms
- Thread Up Truck Adapters and Stackable Extensions - (4) 3.5" and (4) 5"
- Accommodates Trucks and Most Cars



**WARRANTY:** 1 Year Parts and Labor

Shown with Additional Accessories

### 14,000 Lb. 4 Post Lift

SKU OUTSIDE BUY/EPO ROTSM14L

**11,099<sup>99</sup>**

- Filter/Regulator/Lubricator Included to Extend the Life of Lift and Tools
- Max. Wheel Base: 182"
- 78" Rise
- Long Lasting Cables and Sheaves

Rolling Jacks Sold Separately

### Internal Air Line Kit

SKU OUTSIDE BUY/EPO ROTFC5760-14

**784<sup>99</sup>**

**WARRANTY:** 1 Year Parts and Labor



## WORKS WITH

### One 7,000 Lb. Rolling Jack

SKU OUTSIDE BUY/EPO ROTRJ7100Y

**5,349<sup>99</sup>**

Optional Equipment



Customer Responsible For Offloading.

For Outside Buy/EPO, Call 901-300-4878

- Free Delivery in 48 Continental United States
- Specifications Subject to Change without Notice or Liability
- Equipment Lead Times and Shipping May Vary
- Customers Responsible for Offloading Equipment Upon Arrival
- Leasing Terms Available, Ask Your AutoZone® Commercial Sales Manager.

Prices subject to change without notice. Prices do not include applicable taxes, vehicles, tires, rims, installation or optional equipment as shown. Please do not return purchases to the store. For information regarding warranty, repair, or any questions or concerns, call 901-300-4878.

# AUTOMOTIVE LIFTS

FOR HELP with Selection, Confirm Availability and Ordering Instructions, Call 901-300-4878

AUTOMOTIVE LIFTS

## BendPak® Lifts

### 10,000 Lb. 2 Post Lifts

- Bi-Metric™ Reversible Triple Telescoping Swing Arms
- Low-Pro™ Swing Arms

SKU OUTSIDE BUY/EPO  
BEN10AP

**6,649<sup>99</sup>**

- 145" Height, 135" to 145" Width, 69" Rise



BEN10AP

SKU OUTSIDE BUY/EPO  
BEN10AP-168

**7,049<sup>99</sup>**

- 168" Height, 135" to 145" Width, 69" Rise
- 24" Bolt-On Extension for Increased Vehicle Height Clearance

- Automatic Arm Restraints
- Expandable Top Beam Accommodates Wide or Narrow Drive-Thru Configurations

SKU OUTSIDE BUY/EPO  
BEN10APX

**6,899<sup>99</sup>**

- 157" Height, 135" to 145" Width, 75.5" Rise



BEN10APX

SKU OUTSIDE BUY/EPO  
BEN10APX-181

**7,449<sup>99</sup>**

- 181" Height, 135" to 145" Width, 75.5" Rise
- 24" Bolt-On Extension for Increased Vehicle Height Clearance



WARRANTY: 1 Year Parts and Labor

### 12,000 Lb. 2-Post BiMetric Lift

SKU OUTSIDE BUY/EPO  
BEN12APX

**12,549<sup>99</sup>**

- Adaptable Design: Symmetric or Asymmetric
- Automatic Swing Arm Restraint System
- Includes 4 Frame Cradle Pads, 4 Medium and 4 Tall Stacking Adapters



### 12,000 Lb. 2-Post Short-Rise Floorplate Lift

SKU OUTSIDE BUY/EPO  
BEN12AP-SRT

**8,949<sup>99</sup>**

**NEW**

- Post Height: 93.5"
- Max. Lifting Height: 46"

**Great Choice for Low Ceiling Height Where You Do Not Need To Work Underneath the Vehicle**

**INCLUDES:** 4 Frame Cradle Pads, 4 Medium and 4 Tall Stacking Adapters



WARRANTY: 1 Year Parts and Labor

### 16,000 Lb. 2-Post Lift

SKU OUTSIDE BUY/EPO  
BEN16AP

**23,649<sup>99</sup>**

- Telescoping Arms Accommodate a Wide Variety of Vehicle Chassis
- Dual Direct-Drive Hydraulic Cylinders for Smoother Operation and Less Maintenance
- Includes 4 Frame Cradle Pads, 4 Medium and 4 Tall Stacking Adapters with Column-Mounted Racks



**INCLUDES:** 4 Frame Cradle Pads, 4 Medium and 4 Tall Stacking Adapters



WARRANTY: 1 Year Parts and Labor

### 10,000 Lb. Low-Rise Lift

SKU OUTSIDE BUY/EPO  
BENLR-10000

**5,249<sup>99</sup>**

- Min. Height: 4.5"
- Max. Lift Height: 23"
- Lift Height + Blocks: 32"



4.5" to 32" ↑↓

WARRANTY: 1 Year Parts and Labor

### 6,000 Lb. Low-Rise Pad Lift

SKU OUTSIDE BUY/EPO  
BENLR-60

**2,999<sup>99</sup>**

- Min. Height: 3.5"
- Max. Lifting Height: 23"
- Max. Lift Height + 1.5" Blocks: 24.5"



3.5" to 24.5" ↑↓

WARRANTY: 1 Year Parts and Labor

### Portable

SKU OUTSIDE BUY/EPO  
BENLR-60P

**3,099<sup>99</sup>**

- Min. Height: 4"
- Max. Lifting Height: 23"



Customer Responsible For Offloading.

For Outside Buy/EPO, Call 901-300-4878

- Free Delivery in 48 Continental United States
- Specifications Subject to Change without Notice or Liability
- Equipment Lead Times and Shipping May Vary
- Customers Responsible for Offloading Equipment Upon Arrival
- Leasing Terms Available, Ask Your AutoZone® Commercial Sales Manager.

Prices subject to change without notice. Prices do not include applicable taxes, vehicles, tires, rims, installation or optional equipment as shown. Please do not return purchases to the store. For information regarding warranty, repair, or any questions or concerns, call 901-300-4878.

AZG0225

# AUTOMOTIVE LIFTS

## BendPak® Lifts

### 14,000 Lb. 4 Post Lift

SKU OUTSIDE BUY/EPO  
BENHDS14

**8,699<sup>99</sup>**

- Overall Width: 130"
- Overall Length: 241"
- Max. Rise: 70"
- Motor: 220 VAC/1 Ph



### 14,000 Lb. Extended/Limo Style

SKU OUTSIDE BUY/EPO  
BENHDS14X

**9,449<sup>99</sup>**

### Air Line Kit

SKU OUTSIDE BUY/EPO  
BEN5174009

**129<sup>99</sup>**



Shown with Optional Equipment  
Rolling Jacks Sold Separately  
WARRANTY: 1 Year Parts and Labor

## WORKS WITH

### One 7,000 Lb. Capacity Rolling Bridge Jack

SKU OUTSIDE BUY/EPO  
BENRJ7W

**2,399<sup>99</sup>**



Optional  
Equipment

### 9,000 Lb. 4 Post Lift

SKU OUTSIDE BUY/EPO  
BENHD-9

**5,999<sup>99</sup>**

- Overall Width: 110.25"
- Overall Length: 174"
- Column Height: 88" (2,235 mm)
- Max. Lifting Height: 74-1/2" (1,892 mm)



### Air Line Kit

SKU OUTSIDE BUY/EPO  
BEN5174009

**129<sup>99</sup>**



Shown with Optional Equipment  
Rolling Jacks Sold Separately  
WARRANTY: 1 Year Parts and Labor

## WORKS WITH

### One 4,500 Lb. Capacity Rolling Bridge Jack

SKU OUTSIDE BUY/EPO  
BENRJ45W

**2,299<sup>99</sup>**



Optional  
Equipment

## Atlas Equipment

### 10,000 Lb. 2-Post Lift

SKU OUTSIDE BUY/EPO  
ATLAP-PVL10-FPD

**5,199<sup>99</sup>**

- Can be Installed Symmetrically or Asymmetrically
- 3-Stage Front Arms and 2-Stage Rear Arms
- Comes with Direct Drive Cylinders
- Single Point Lock Release



**NEW**



WARRANTY: 2 Years Hydraulics, 2 Years Power Unit

### Computerized Wheel Balancer

SKU OUTSIDE BUY/EPO  
ATLATWB41-FPD

**2,099<sup>99</sup>**

- Computer Controlled Motorized Spin Balancer
- Static and Dynamic Balancing Modes
- Self Diagnosing/Self-Calibrating
- Includes: Plastic Quick-Release Nut, 4 Centering Cones, Wheel Weight Pliers and Measuring Calipers for Complete Setup
- Max Rim Diameter: 32"

**NEW**



WARRANTY: 1 Year Parts Only

### 12,000 Lb. 2-Post Lift

SKU OUTSIDE BUY/EPO  
ATLAP-PVL12-FPD

**7,899<sup>99</sup>**

- Low Pad Height Allows this Lift to Accommodate Both Long Wheel Base Trucks and Passenger Cars
- Extra Tall and Extra Wide
- 3-Stage Symmetric Arms
- Comes with Direct Drive Cylinders
- Single Point Lock Release

**NEW**



WARRANTY: 2 Years Hydraulics, 2 Years Power Unit

### Extra Large Turntable Rim-Clamp Tire Changer

SKU OUTSIDE BUY/EPO  
ATLATTC289-FPD

**2,699<sup>99</sup>**

- Extra-Large Turntable
- Metal Mount/Demount Head with Metal Roller or Replaceable Plastic Inserts
- Filter/Regulator/Lubricator Included to Ensure Smooth Operation
- Includes Tire Tool, Lube Bucket with Brush, Large Plastic Jaw Covers and Plastic Cover for Bead Breaker Shovel
- Maximum Tire Capacity: 47" Diameter, 18" Wheel Width, 5,500 Lb. Bead Breaker Force

**NEW**



WARRANTY: 1 Year Parts Only



Customer Responsible For Offloading.

For Outside Buy/EPO, Call 901-300-4878

- Free Delivery in 48 Continental United States
- Specifications Subject to Change without Notice or Liability
- Equipment Lead Times and Shipping May Vary
- Customers Responsible for Offloading Equipment Upon Arrival
- Leasing Terms Available, Ask Your AutoZone® Commercial Sales Manager.

# AUTOMOTIVE LIFTS

FOR HELP with Selection, Confirm Availability and Ordering Instructions, Call 901-300-4878

AUTOMOTIVE LIFTS

## Mid-Rise Lifts

**BendPak**

### 6,000 Lb. Portable Mid-Rise Lift

SKU **OUTSIDE BUY/EPO** **3,449<sup>99</sup>**  
**BENMD-6XP**

- Portable, Easy to Move from Bay to Bay
- Adjustable Arms



4.75" to 47" ↑↓

**INCLUDES:**  
Truck Adapters

**WARRANTY:**  
1 Year Parts and Labor

**CL Challenger Lifts**

### 6,000 Lb. Mid-Rise Portable Lift

SKU **OUTSIDE BUY/EPO** **3,619<sup>99</sup>**  
**CHLMR6**

- 6 Safety Lock Positions
- Standard High and Low Adapters
- Sliding/Rotating Arm Design Reaches Pick-Up Points on a Wider Range of Vehicles
- Zerk Fittings on Pivot Points for Serviceability



5.5" to 52" ↑↓

**WARRANTY:**  
1 Year Parts and Labor

**CL Challenger Lifts**

### 10,000 Lb. Short Rise Lift

SKU **OUTSIDE BUY/EPO** **5,199<sup>99</sup>**  
**CHLSRM10**

- Min. Height: 4.25"
- Max. Height 22"
- Includes: (4) 2 Position Adapter Blocks



4.25" to 22" ↑↓

**WARRANTY:**  
1 Year Parts and Labor

## MaxJax Lift

**MAXJAX**

### MaxJax M7K

SKU **OUTSIDE BUY/EPO** **4,499<sup>99</sup>**  
**MJXM7K**

- Min. Pad Height: 5.5"
- Height Overall: 89.5"
- Max. Lift Height: (Pad Only) 47.25" (With 3" Adapter) 50.5"
- Clear Undercar Access
- Portability
- Stow to Go in Less Than 15 Minutes



**WARRANTY:**  
1 Year Parts and Labor

## QuickJack™ Lifts

**QUICKJACK™**

### You get it all.

- Complete Package Includes: 2 Jack Frame Assemblies, (2) 150" Hydraulic Hoses, (2) 14" Aux. Hoses, 2 Quick-Mount Handles, (4) 1.5" x 3" x 4" Rubber Lifting Blocks, (4) 3" x 3" x 4" Rubber Lifting Blocks, 1 Mini Hydraulic Power Unit with Pendant Control



### 7,000 Lb. Portable Car Lift System - Extended

SKU **OUTSIDE BUY/EPO** **2,199<sup>99</sup>**  
**QJK7000TLX**

- Capacity: 7,000 Lb. (3,175 kg)
- Lowered Height: 3.5" (89 mm)
- Maximum Height: 24.5" (622 mm)
- Max. Lift Point Spread: 66" (1,676 mm)
- Min. Lift Point Spread: 43" (1,092 mm)
- Frame Length: 76" (1,930 mm)
- Frame Width: 12.5" (318 mm)
- Frame Weight: 103 Lb. (47 kg)
- Total Shipping Weight: 304 Lb. (138 kg)

12V DC Options Available



### QuickJack™ SUV and Light Truck Adapters

SKU **862288** **239<sup>99</sup>**  
**RAN5150561**

- Fits BL-5000 and BL-7000 Series
- Set of 12 Pieces Includes: 4 Low Profile Round Polyurethane Contact Pads, 4 Sliding Receivers That Accommodate the Round Polyurethane Contact Pads and (4) 3" Stackable Adapters



## Motorcycle Lift

**OEM TOOLS**

### Air Hydraulic Motorcycle Lift 1,000 Lb. Capacity

SKU **662742** **999<sup>99</sup>** **SAVE \$300**  
**24859** REG. \$1,299.99

#### Our Lift Compares to Top Brand Motorcycle Lifts in Every Way

- 86.5" x 26.75" Platform Deck with 25.5" Long Removable Loading Ramp
- Built-In Casters and Adjustable Stabilizers
- Durable 12 Gauge, Powder Coated Diamond Plate Deck
- Air/Hydraulic Lift System Allows Use with Shop Air or as a Manual Lift
- Tie Down Rings on Deck for Added Stability



Heavy Duty, Positive Shop, Padded Wheel Vise

Rear Dropout Panel (for Rear Tire Maintenance Access)

Offer Good Through June 30, 2025



Customer Responsible For Offloading.

For Outside Buy/EPO, Call 901-300-4878

- Free Delivery in 48 Continental United States
- Specifications Subject to Change without Notice or Liability
- Equipment Lead Times and Shipping May Vary
- Customers Responsible for Offloading Equipment Upon Arrival
- Leasing Terms Available, Ask Your AutoZone® Commercial Sales Manager.

Prices subject to change without notice. Prices do not include applicable taxes, vehicles, tires, rims, installation or optional equipment as shown. Please do not return purchases to the store. For information regarding warranty, repair, or any questions or concerns, call 901-300-4878.

AZG0225

95

# AUTOMOTIVE LIFTS

## Lift Pads



### Forward/Eagle/Gemini/ Worth/American Hexagon Shaped - 2 Bolt Style Lift Pads (Set of 4)

SKU 1137807 **74<sup>99</sup>**  
SHA51663



### Fits Models

I-DP9, DP09A2,  
DP09A, DP07A,  
DP97A, DP7A,  
Eagle and Other  
Texas Style  
2 Post Lifts

### Replaces

OEM#  
994105,  
991234,  
991222 and  
LP603

### Challenger Hexagon Shaped - 2 Bolt Style Lift Pads (Set of 4)

SKU 1137812 **99<sup>99</sup>**  
SHA51661



20000, 21000,  
26000, 27000,  
28000, 30000,  
31000, 33000,  
36000, 37000,  
39000

OEM#  
JOK01D,  
LP602

### Rubber Round Slip-on Lift Pad

SKU OUTSIDE BUY/EPO **24<sup>99</sup>**  
CHLB2208



For Outside Buy/EPO,  
Call 901-300-4878

Challenger CL10, E10,  
Q10, VS10 and  
Ammco AC21NS

N/A

### Challenger and Quality Round Slip-On Lift Pads

SKU 1137816 **54<sup>99</sup>**  
SHA51673



VS10, CI10, E10,  
TLT210, TLT210-AS,  
TLT211, TLT211-AS,  
ACD210S and More

OEM#  
104130315,  
B2208

### Rotary Square Bolt Style Lift Pads (Set of 4)

SKU 1137817 **124<sup>99</sup>**  
SHA51667



SPO9, SPOA9,  
SPO10, SPOA10,  
SPO12, SI29,  
SL19, SL210

OEM#  
FJ6213,  
BH-7536-92P,  
BH7542-73  
and LP609

### BendPak Square Slip-On Lift Pads (Set of 4)

SKU 1137805 **124<sup>99</sup>**  
SHA51666



MX10AC, MXACX,  
X10CX, MX10C,  
XPR-9S, XPR-9S-LP,  
XPR-9DS, XPR-10S,  
XPR-10S-LP,  
XPR-10S-168,  
XPR-10AS,  
XPR-10AS-LP,  
XPR-10AS-168,  
XPR-12FDL,  
XPR-12CL, XPR-15CL,  
XPR-18CL,  
XPR-12CL-192,  
XPR-15CL-192,  
XPR-18CL-192, RJ6,  
RJ6000, RJ4500

OEM#  
5715-365  
and LP608

## Challenger



### Electric Vehicle Footpad

SKU OUTSIDE BUY/EPO **819<sup>99</sup>**  
CHLTFFPK

- Sold in Set of 4
- Designed Specifically to Work on Electric Vehicles
- Fits most Challenger 2-Post Lifts
- For Use with All 10K, 12K, and 16K 2-Post Lifts
- For Use with EV1020, EV1220, EW1020 and EW1220 In-Ground Lifts

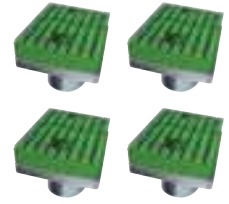

### Truck Adapter Set for 10,000 Lb. and 12,000 Lb. 2 Post Lifts

SKU OUTSIDE BUY/EPO **434<sup>99</sup>**  
CHL10315

- Stack Adapter Extension Kit Includes:  
(4) 3" Stack Extensions,  
(2) 6" Stack Extensions and  
2 Organizer Racks with Hardware



### GM Wide Frame Footpads (Pair)

SKU OUTSIDE BUY/EPO **629<sup>99</sup>**  
CHLB2280PR

- Fits 2008 and Up Challenger Lifts CL10V3, E10, LE10, VLE10, SA10, CLFP9, E12, CL12 and EV1020 Models
- Works on 2019 GMC Sierra and Chevrolet Silverado Trucks
- Drop-In Design Makes Switching Simple and Quick
- Telescoping Feature Provides Simple Access to Lift Points



For Outside Buy/EPO, Call 901-300-4878

## BendPak

### Rubber 2 Post Lift Pad/Slip Over (Set of 4)

SKU 954179 **89<sup>99</sup>**  
BEN5700227

- Heat and Cold Resistant
- Highly Resistant to Gouging
- Oil and Solvent Resistant
- Tear Resistant



## BendPak

### Lift Pad Assembly/ 35 mm Pin (Set of 4)

SKU 1053947 **209<sup>99</sup>**  
BEN5215753

- Works with Any BendPak 2 Post Lift
- Thick Rubber Construction
- Textured Surface for Extra Grab
- Will Not Scratch the Vehicle
- Easy Drop-In Design
- 5" Diameter for Enhanced Stability



### Cradle Pads

- Tactile Rubber Pad Reduces Slippage and Protects the Finish
- Made for Heavy Duty Commercial-Grade Trucks
- Installs Easily to BendPak 2 Post Lift Arms
- Sturdy Steel Construction

### Frame Cradle Pads 35 mm Pin (Set of 4)

SKU 954221 **219<sup>99</sup>**  
BEN5215754

### Wide Frame Cradle Pads 60 mm (Set of 2)

SKU 979067 **229<sup>99</sup>**  
BEN5215848



Prices subject to change without notice. Prices do not include applicable taxes, vehicles, tires, rims, installation or optional equipment as shown. Please do not return purchases to the store. For information regarding warranty, repair, or any questions or concerns, call 901-300-4878.



## COOL BOSS™ By BendPak

**Superior Design, Next Level Performance**



Featuring industry leading tank capacity, the **CoolBlast** Series keeps you cooler, longer - without being tethered to a hose.

### CoolBlast SERIES



### CoolBreeze SERIES

**CLBCB-12SL**  
SKU 1360694

**1,399<sup>99</sup>**

- 15 Gal. Capacity
- 3,960 CFM

**CLBCB-14SL**  
SKU 1400037

**1,649<sup>99</sup>**

- 15.6 Gal. Capacity
- 4,340 CFM

**CLBCB-19SL**  
SKU Outside Buy

**849<sup>99</sup>**

- 15.6 Gal. Capacity
- 5,890 CFM

**CLBCB-26SL**  
SKU 1400045

**3,049<sup>99</sup>**

- 50 Gal. Capacity
- 7,540 CFM

**CLBCB-16L**  
SKU 1275460

**2,599<sup>99</sup>**

- 60 Gal. Capacity
- 4,960 CFM

**CLBCB-28L**  
SKU 1275461

**3,499<sup>99</sup>**

- 80 Gal. Capacity
- 8,120 CFM

**CLBCB-28HV**  
SKU Outside Buy

**3,799<sup>99</sup>**

- 80 Gal. Capacity
- 12,180 CFM

**CLBCB-36L**  
SKU 1275465

**4,499<sup>99</sup>**

- 115 Gal. Capacity
- 10,440 CFM

© 2025 CoolBoss. All rights reserved. CoolBoss is a registered trademark of BendPak.

## Ranger® SELECT™

Now available from Ranger, **Ranger Select** provides the same commercial-grade wheel service equipment with *included* set up and training. Expert technicians ensure precise installation, calibration, and testing for optimal performance. With a focus on efficiency and durability, we minimize downtime and keep your equipment running at its best.

**NEW  
ON-SITE  
SERVICE**



\*FREE SHIPPING to direct shipping points within the 48 contiguous United States only.

**BendPak®**

# TIRE SERVICE

## Coats Combos

### RC-45E and 885 Tire Service Combo

SKU **OUTSIDE BUY/EPO**  
AMMCOMB05

- External Rim Clamping Range from 6" to 24" (Max. Tire Diameter 50"; Max. Rim Width 10.5")
- Tire Changer Allows Inflation from 0 to 60 psi with a Built-In Pressure Limiter
- RC-45E Drive System: 1 HP Electric Motor
- 885 Balancer - Automatic Distance and Diameter Entry
- Direct Tape-A-Weight® Placement
- Auto Start Hood
- 110V



AMM800885

**SAVE**  
**\$349**

**9,799<sup>99</sup>**



AMM8560994901

AMM8560994901	\$5,649.99
AMM800885	\$4,499.99
Regular Price	<b>\$10,149.98</b>
<b>COMBO PRICE</b>	<b>\$9,799.99</b>
<b>SAVINGS</b>	<b>\$349.99</b>

**INCLUDES:**  
Setup and Training

WARRANTY: 3 Years Parts and 6 Months Labor

### RC-55E and 1300 Series Tire Service Combo

SKU **OUTSIDE BUY/EPO**  
AMMCOMB02

- RC-55E Features an External Clamping Range from 6" to 24" (Max. Tire Diameter 50"; Max. Rim Width 10-1/2")
- RC-55E Drive System: 1 HP Electric Motor
- Tire Changer Allows Inflation from 0 to 60 psi with a Built-In Pressure Limiter
- 1300 Series Wheel Balancer is Powered by Direct Drive
- Static-On-Screen® Display Identifies Any Excess Residual Static Imbalance
- Wheel Balancer Automatically Enters 2-D Data for Wheel Diameter and Offset Measurement



AMM80013002D

**SAVE**  
**\$449**

**13,199<sup>99</sup>**

## GOATS

AMM8560995001



AMM8560995001	\$7,699.99
AMM80013002D	\$5,949.99
Regular Price	<b>\$13,649.98</b>
<b>COMBO PRICE</b>	<b>\$13,199.99</b>
<b>SAVINGS</b>	<b>\$449.99</b>

**INCLUDES:** Setup and Training

WARRANTY: 3 Years Parts and 6 Months Labor

## DON'T FORGET THESE ACCESSORIES

- Works with Coats Wheel Balancers Listed on This Page

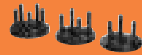

Adjustable Pin Plate Set **2,049<sup>99</sup>**

SKU **OUTSIDE BUY/EPO** | AMM85610104



40 mm Light Truck Cone **419<sup>99</sup>**

SKU **OUTSIDE BUY/EPO** | AMM8113277C

Customize Your Own Combo, Call for Special Pricing **901-300-4878**

## Rotary Combo

### R146P and R155 Tire Service Combo

SKU **OUTSIDE BUY/EPO**  
ROTCOMB04

- Includes: R146P Tire Changer and R155 Balancer High Quality Swing Arm Changer and Pro 3D Wheel Balancer at an Economical Price
- Changer Offers 26" Outside and 28.5" Inside Clamping with Tire Diameters Up to 46"
- PLUS91SA Helper Arm Not Installed Prior to Delivery
- Balancer Features Automatic Program, Linked Keyboard, Internal Data Gauge, and Simple Visual Display

#### R146P

- Inside Clamping: 12 to 28.5"
- Outside Clamping: 10 to 26"
- 115V, Single Phase

#### R155

- Rim Diameter: 10" to 30"
- Rim Width: 1.5" to 22"
- 115V, Single Phase
- 8 Piece Collet Kit Included



ROTR146P

ROTR155

ROTR146P	\$8,349.99
ROTR155	\$7,799.99
Regular Price	<b>\$16,149.98</b>
<b>COMBO PRICE</b>	<b>\$15,349.99</b>
<b>SAVINGS</b>	<b>\$799.99</b>

**INCLUDES:** Setup and Training

WARRANTY: 3 Years Parts and 1 Year Labor

## Hofmann Combo

### Geodyna® 7100 Balancer and monty® 1270 Tire Service Combo

SKU **OUTSIDE BUY/EPO**  
HOFCOMB01TS

- Economical and Practical Package from a Brand You Can Trust
- Small Footprint Wheel Service Package Great for Low Volume Shops
- Great Choice for Second System in High Volume Shops
- Ergonomic and User-Friendly Design



HOFEEWB761AE1

HOFEEWH764AU1

HOFEEWH764AU1	\$4,849.99
HOFEEWB761AE1	\$4,849.99
Regular Price	<b>\$9,699.98</b>
<b>COMBO PRICE</b>	<b>\$6,449.99</b>
<b>SAVINGS</b>	<b>\$3,249.99</b>

**SAVE**  
**\$3,249**

**6,449<sup>99</sup>**

User Setup Required

WARRANTY: 1 Year Parts and 6 Months Labor



Customer Responsible For Offloading, Liftgate Service Available.

For Outside Buy/EPO, Call 901-300-4878

- Free Delivery in 48 Continental United States
- Specifications Subject to Change without Notice or Liability
- Equipment Lead Times and Shipping May Vary
- Customers Responsible for Offloading Equipment Upon Arrival
- Leasing Terms Available, Ask Your AutoZone® Commercial Sales Manager.

Prices subject to change without notice. Prices do not include applicable taxes, vehicles, tires, rims, installation or optional equipment as shown. Please do not return purchases to the store. For information regarding warranty, repair, or any questions or concerns, call 901-300-4878.

# TIRE SERVICE

FOR HELP with Selection, Confirm Availability and Ordering Instructions, Call 901-300-4878

TIRE SERVICE

## CEMB Combo

### EZ10 and SM825EVOPA Swing Arm Tire Changer Combo

SKU OUTSIDE BUY/EPO **10,299<sup>99</sup>**  
CMBCOMB03

- Tire Changer Clamping Range of 13" to 24"
- Max. Tire Diameter 44" and Max. Tire Width 15"
- Powerful and Adjustable Bead Breaker Shovel
- Dual Clamping Cylinders and Semi-Automatic Swing Arm
- 3D Wheel Measurement with Sonar
- Automatic Approach and Auto Adaptive Mode to Save Balancing Time
- Electromagnetic Brake
- 3D Inner Data Entry Arm Eliminates Rim Width Caliper Use
- Direct Measures Input Feature Eliminates Selection of Balancing Modes
- Guided Weight Placement, ALU, Hidden Spoke Modes

On-Site Training Included

WARRANTY: 2 Years Parts and 1 Year Labor

**SAVE \$1,199**



Includes Press Arm



CMBEZ10	\$4,949.99
CMBSM825EVOPA	\$6,549.99
Regular Price	<b>\$11,499.98</b>
<b>COMBO PRICE</b>	<b>\$10,299.99</b>
<b>SAVINGS</b>	<b>\$1,199.99</b>

## Baseline Combo

### BL300 Tire Changer and BL350 Balancer Combo

SKU OUTSIDE BUY/EPO **5,649<sup>99</sup>**  
AMM8500300350

- Includes: BL300 Tire Changer and BL350 Balancer
- 10" to 24" External Clamping Capacity
- Bead Sealing Jets to Aid Inflation
- BL350 Balancer Features Self Diagnosis and Calibration
- One Button Split and Hidden Weight Program

User Setup Required  
WARRANTY: 1 Year Parts

**SAVE \$799**



AMM85002300	\$3,349.99
AMM85002350	\$3,099.99
Regular Price	<b>\$6,449.98</b>
<b>COMBO PRICE</b>	<b>\$5,649.99</b>
<b>SAVINGS</b>	<b>\$799.99</b>

## Ranger Combos

### R980XR and DST-2420 Tire Service Combo

SKU OUTSIDE BUY/EPO **6,999<sup>99</sup>**  
RANCOMB01

- Includes: R980XR NEXTGEN™ Swing-Arm 30" Tire Changer and the DST-2420 Dynamic Wheel Balancer
- R980XR External Rim Clamping Capacity: 9" to 28", Internal Clamping 10" to 30"
- 3-Position RimGuard™ Wheel Clamps
- DST-2420 Dynamic Wheel Balancer Dependably Ensures an Accurate Result within Hundredths of an Ounce

RANR980XR	\$4,349.99
RANDST2420	\$2,899.99
Tape Wheel Weights Combo	\$139.99
Regular Price	<b>\$7,389.97</b>
<b>COMBO PRICE</b>	<b>\$6,999.99</b>
<b>SAVINGS</b>	<b>\$389.98</b>

User Setup Required  
WARRANTY: 1 Year Parts and Labor

**SAVE \$389**



### R76ATR & LS43B Tire Service Combo

SKU OUTSIDE BUY/EPO **10,899<sup>99</sup>**  
RANCOMB02

- Includes R76ATR Tire Changer and LS43B Wheel Balancer
- Tilt Tower Tire Changer Has an External Rim Clamping Capacity of 9" to 28", Power Assist Tower and Inflation System
- LS43B Laser Wheel Balancer Optimizes Wheel Weight Placements with Exclusive Laser-Spot™ Technology and Easy-to-Read Display

RANLS43B	\$4,599.99
RANR76ATR	\$6,549.99
Tape Wheel Weights Combo	\$139.99
Regular Price	<b>\$11,289.97</b>
<b>COMBO PRICE</b>	<b>\$10,899.99</b>
<b>SAVINGS</b>	<b>\$389.98</b>

User Setup Required  
WARRANTY: 1 Year Parts and Labor

**SAVE \$389**



**BEFORE PLACING YOUR TIRE SERVICE ORDER:**

Please verify minimum air pressure and CFM along with voltage and phase. See page 2 for delivery information or **Call 901-300-4878.**



Customer Responsible For Offloading, Liftgate Service Available.

For Outside Buy/EPO, Call 901-300-4878

- Free Delivery in 48 Continental United States
- Specifications Subject to Change without Notice or Liability
- Equipment Lead Times and Shipping May Vary
- Customers Responsible for Offloading Equipment Upon Arrival
- Leasing Terms Available, Ask Your AutoZone® Commercial Sales Manager.

Prices subject to change without notice. Prices do not include applicable taxes, vehicles, tires, rims, installation or optional equipment as shown. Please do not return purchases to the store. For information regarding warranty, repair, or any questions or concerns, call 901-300-4878.

AZG0225

# TIRE SERVICE

## Tire Changers

### Maxx 50 Tire Changer, 110V

SKU OUTSIDE BUY/EPO  
AMM800MAXX50E **6,649<sup>99</sup>**

- Dual Nozzle, Hi-Flow Bead Sealing System for Quick, Easy Bead Sealing
- 110V Electric Operation, Plug In Almost Anywhere
- 6" to 24" Steel Clamps Standard
- Nylon Duckhead Standard
- Expanded Capacity to 16" Wheel Width, and Up to 50" Total Diameter



### Maxx 50

### Tire Changer, Air

SKU OUTSIDE BUY/EPO  
AMM800MAXX50A **6,649<sup>99</sup>**

### Maxx 70 Tire Changer, 110V

SKU OUTSIDE BUY/EPO  
AMM800MAXX70 **8,699<sup>99</sup>**

- Dual Nozzle, Hi-Flow Bead Sealing System for Quick, Easy Bead Sealing
- 110V Electric Operation, Plug in Almost Anywhere
- Expanded Capacity to 16" Wheel Width and Up to 50" Total Diameter
- 6" to 24" Steel Clamps Standard
- Steel and Nylon Duckheads Standard
- No-Index Tabletop for High Efficiency Use



### Maxx 70

### Tire Changer, Air

SKU OUTSIDE BUY/EPO  
AMM800MAXX70A **8,699<sup>99</sup>**

### Maxx 70 Tire Changer, 220V, 2 HP

SKU OUTSIDE BUY/EPO  
AMM800MAXX70220 **8,699<sup>99</sup>**

### Maxx 80 Tire Changer, 110V

SKU OUTSIDE BUY/EPO  
AMM800MAXX80 **10,249<sup>99</sup>**

- Dual Nozzle, Hi-Flow Bead Sealing System for Quick, Easy Bead Sealing
- Dual Control, Hand or Foot Operated Bead Loosener System
- 110V Electric Operation, Plug in Almost Anywhere
- 6" to 24" Steel Clamps and Zinc Plated 6" to 24" Grip Max 2.0 Clamps with Dual Soft Compound Inserts
- Expanded Capacity to 16" Wheel Width and Up to 50" Total Diameter
- Steel and Nylon Duckheads Standard
- No-Index Tabletop for High Efficiency Use
- Includes Storage Cabinet



### Maxx 80

### Tire Changer, Air

SKU OUTSIDE BUY/EPO  
AMM800MAXX80A **10,249<sup>99</sup>**

### Maxx 80 Tire Changer, 220V, 2 HP

SKU OUTSIDE BUY/EPO  
AMM800MX80220 **10,249<sup>99</sup>**

**INCLUDES:** Setup and Training

**WARRANTY:** 3 Years Parts and 6 Months Labor

## Coats Wheel Balancers

### 1600A 3D Wheel Balancer

SKU OUTSIDE BUY/EPO  
AMM80016003D **10,499<sup>99</sup>**

- Powered by Direct Drive
- Max. Tire Diameter: 44"
- Premium Quicknut
- Behind-the-Spoke Balancing
- 8 Piece Collet Kit
- Automatic 3-D Data Entry
- Touch-Screen
- 220V, 1 Phase



**INCLUDES:** Setup and Training

### 1500A 3D Wheel Balancer

SKU OUTSIDE BUY/EPO  
AMM80015003D **9,249<sup>99</sup>**

- Powered by Direct Drive
- Max. Tire Diameter: 44"
- Behind-the-Spoke Mode
- Premium Quicknut
- 8 Piece Collet Kit
- Automatic 3-D Data Entry
- 220V, 1 Phase



**WARRANTY:** 3 Year Parts and 6 Months Labor

## CEMB Wheel Balancer

### Automatic Wheel Balancer with Monitor

SKU OUTSIDE BUY/EPO  
CMBER65

**6,249<sup>99</sup>** **SAVE \$550**

REG. \$6,799.99

- Auto-Data Entry of Distance, Diameter and Width
- Laser Pointer for Weight Placement
- 17" Monitor with Intuitive Software
- Auto-Approach Positions Wheel at Correction Point



Offer Good Through  
June 30, 2025

On-Site Training Included

**WARRANTY:** 2 Years Parts and 1 Year Labor



Customer Responsible For Offloading, Liftgate Service Available.

For Outside Buy/EPO, Call 901-300-4878

- Free Delivery in 48 Continental United States
- Specifications Subject to Change without Notice or Liability
- Equipment Lead Times and Shipping May Vary
- Customers Responsible for Offloading Equipment Upon Arrival
- Leasing Terms Available, Ask Your AutoZone® Commercial Sales Manager.

# TIRE SERVICE

FOR HELP with Selection, Confirm Availability and Ordering Instructions, Call 901-300-4878

TIRE SERVICE

## Ranger

### R76ATR Tilt-Back Tire Changer with Assist Tower

SKU OUTSIDE BUY/EPO  
RANR76ATR

**6,549<sup>99</sup>**

- Motor: 3 HP/220V
- Alloy and Nylon Mount and Demount Heads
- External Rim Clamping Capacity: 9" to 28"
- Power Assist Tower Right Side
- Available in 110V or 220V Power Option



### DST-2420 Tire Balancer

SKU OUTSIDE BUY/EPO  
RANDST2420

**2,899<sup>99</sup>**

- Motor: 1.5 HP, 110V/220V, 50/60 Hz, 1Ph
- Balancing Modes: Dynamic/Static/3-Alloy
- Quick-Release Hub Nut for Dramatically Reduced Set-Up Times
- Max Tire Diameter: 47"
- Balancing Speed: 180 RPM
- Balance Increments: 0.25 or 0.01 Oz.



### R980XR NextGen™ Swing-Arm Tire Changer

SKU OUTSIDE BUY/EPO  
RANR980XR

**4,349<sup>99</sup>**

- Motor: 3 HP/220V
- Drive System Type: Electric/Air
- Adjustable RimGuard™ Wheel Clamps
- External Rim Clamping Capacity: 9" to 28"
- Internal Rim Clamping Capacity: 10" to 30"
- Max. Tire Diameter: 50" (1,270 mm)
- Bead Seating System: Turbo Blast/Bead Seating



### DST30P Direct Drive Wheel Balancer

SKU OUTSIDE BUY/EPO  
RANDST-30P

**3,199<sup>99</sup>**

- Ergonomic Control Board and Easy-to-Read LED Display
- Dynamic, Static and Performance Alloy Settings
- Automatic Rolling Wheel Parameter Setting
- Low RPM Balancing Speed
- Automatic Braking
- Quick-Release Hub Nut
- Wheel Width Capacity: 1.2" to 20"
- Max. Wheel Diameter: 8" to 30"



**INCLUDES: 74<sup>38</sup> Value**  
Wheel Weight Starter Kit 100-Piece Silver Roll and 100-Piece Black Roll

### LS43B Wheel Balancer

SKU OUTSIDE BUY/EPO  
RANLS43B

**4,599<sup>99</sup>**

- Included Cones: 3 Standard, 1 Truck
- Cycle Time: 6 Seconds (Avg.)
- Balancing Modes: Dynamic/Static/3-Alloy
- Max. Tire Diameter: 43" (1,100 mm)
- Max. Tire Weight: 145 Lb. (65 kg)
- Wheel Diameter Capacity: 12" to 26" (304 mm to 660 mm)
- Wheel Width Capacity: 4" to 15" (102 mm to 381 mm)



**INCLUDES: 74<sup>38</sup> Value**  
Wheel Weight Starter Kit 100-Piece Silver Roll and 100-Piece Black Roll

User Set-Up Required

WARRANTY: 1 Year Parts and Labor

**Do you work on Trucks, Vans, or SUVs?  
DON'T FORGET THIS ACCESSORY**

### 40 mm Truck Cone Kit

SKU OUTSIDE BUY/EPO | RAN5150032 **449<sup>99</sup>**

Works with Ranger Wheel Balancers Listed on This Page



## Hofmann

### Monty® 3550EM Tire Changer with smartSpeed™

SKU OUTSIDE BUY/EPO  
HOFEWH747B

**12,349<sup>99</sup>**

- smartSpeed™ Technology Automatically Controls Turntable Speed and Torque to Minimize Tire and Wheel Damage
- Push-Button Controlled Mount/Demount Head Pneumatically Lowers and Locks into Position, Automatically Indexing Away from the Wheel to Prevent Contact and Damage
- Fast and Ergonomic Pneumatic Vertical Arm Automatically Re-Positions the Mounting Head to Minimize Wheel Damage
- High Capacity Tire Changer Allows for Broadest Tire and Wheel Assembly Coverage
- Clamping Range: Inside 12" to 28"; Outside 12" to 26"
- Max. Tire Diameter: 47"
- Max. Tire Width: 17"



**INCLUDES: Setup and Training**

WARRANTY: 1 Year Parts and 6 Months Labor

## HOFMANN

### Geodyna® 7600P with Laser and Power Clamp

SKU OUTSIDE BUY/EPO  
HOFEWB765AP

**9,049<sup>99</sup>**

- Power Clamp Clamps Wheel Accurately with Constant Force
- Smart Sonar™ Delivers Automatic, Non-Contact Rim Width
- Acquisition Split Weight Mode, Allows Exact Placement of Weights Behind Spokes



**INCLUDES: Setup and Training**

WARRANTY: 1 Year Parts and 6 Months Labor

## Manatec

MANATEC USA  
ALIGNED TO EXCELLENCE

### DL-65 DSP C Wheel Balancer

SKU OUTSIDE BUY/EPO  
MANDL65-DSPC

**1,499<sup>99</sup>**

- Static and Dynamic Balancing
- Automatic Start with Wheel Guard Closure
- Unbalance Recalculation
- Self-Calibration
- 7 Modes of Alloy Wheel Functions
- Normal and Fine Measurement
- Motor Power: 0.35 HP
- Maximum Wheel Diameter: 39"



User Setup Required

WARRANTY: 1 Year Parts



Customer Responsible For Offloading, Liftgate Service Available.

For Outside Buy/EPO, Call 901-300-4878

- Free Delivery in 48 Continental United States
- Specifications Subject to Change without Notice or Liability
- Equipment Lead Times and Shipping May Vary
- Customers Responsible for Offloading Equipment Upon Arrival
- Leasing Terms Available, Ask Your AutoZone® Commercial Sales Manager.

Prices subject to change without notice. Prices do not include applicable taxes, vehicles, tires, rims, installation or optional equipment as shown. Please do not return purchases to the store. For information regarding warranty, repair, or any questions or concerns, call 901-300-4878.

AZG0225

101

# TIRE SERVICE

## TPMS Tools

### VT37 TPMS Sensor Activation and Programming Tool

SKU 1343925 **279<sup>99</sup>**  
ATEVT37-0000

- Search TPMS Sensor Replacement Part Numbers
- Test Keyfob Signal Strength/Battery Status
- Install and Service TPMS Retrofit Kits

Includes 2 Years Software Updates and 1 Year Warranty



**ATEQ**

### VT67 TPMS and Tire Management Diagnostic Tablet

SKU OUTSIDE BUY/EPO **1,399<sup>99</sup>**  
ATESM67-8BLE

- Secure Gateway (SGW) Ready for Stellantis Vehicles
- Save, Manage and Edit Customer Jobs and Reports on the Cloud
- Program and Clone 20+ Aftermarket Sensor Brands
- Export and Send Complete Customer Reports via Email
- TPMS Sensor and Service Kit Image Library for Easy Reference
- ID Match Functionality to Troubleshoot and Repair TPM Systems
- Tire Management: Tread Reading, Wheel Inspection, Tire Registration
- Built-In HD Camera for Accurate Vehicle and Wheel Inspection

Includes 8 Bluetooth Sensors

**VALUE: \$479.92**

Includes 1 Year Software Updates and 1 Year Warranty



**ATEQ**

### VT47 TPMS Programming Tool

SKU OUTSIDE BUY/EPO **729<sup>99</sup>**  
ATESM47-12SC

- TPMS Sensor Part Number Look-Up (OE and Aftermarket)
- Change Placard Values When Swapping Tire Sizes
- Includes: 12 Dual Band Sensors with Both Metal and Rubber Valve Stems

Includes 12 Dual Band Sensors

**VALUE: \$299.88**

Includes 5 Years Software Updates and 1 Year Warranty



**ATEQ**

### VT57 TPMS and Tire Management Tool

SKU OUTSIDE BUY/EPO **1,099<sup>99</sup>**  
ATESM57-20SC

- All-New Updated User Interface
- Touch-Screen Capability
- Includes: 20 Sensors Dual Band Sensors with Both Rubber and Metal Valve Stems

Includes 20 Dual Band Sensors

**VALUE: \$499.80**

Includes 5 Years Software Updates and 1 Year Warranty



**ATEQ**

### Dual Band TPMS Sensor

SKU OUTSIDE BUY/EPO **24<sup>99</sup>**  
SIMSM-1SC

- Dual Band TPMS
- Aluminum and Rubber Valve Included
- 98% Coverage Tested and Validated in USA
- Live Tech Support



**ONE**  
DIRECT SENSOR

### Bluetooth Pre-Programmed Sensors

SKU OUTSIDE BUY/EPO **59<sup>99</sup>**  
SIMSM-BLE

- Tesla, OE Like
- Future Proof, OE Like
- Plug and Play
- Black Valve
- Live Tech Support



**ONE**  
DIRECT SENSOR

For Outside Buy/EPO, Call 901-300-4878

## FUNCTIONALITY

	VT37	TS47	TS57	VT67
Reads, Diagnoses and Activates 100% of OE and Aftermarket Sensors, Including 2022 Coverage	✓	✓	✓	✓
VIN Barcode Scanner to Select Make, Model and Year			✓	✓
Wi-Fi and Real-Time Updates Powered by Live Sensor™		✓	✓	✓
Programs Aftermarket Sensors (Including EZ-Sensor® and All Leading Brands)	✓	✓	✓	✓
Secure Gateway (SGW) Ready for Stellantis Vehicles and Others				✓
Provides Direct (OBD, Auto, Manual) and Indirect TPMS Relearn Procedures	✓	✓	✓	✓
98.6% TPMS Reset Coverage, Including Bonus ECU Reset Coverage in <2 Min. (OBD Connectivity)		✓	✓	✓
ECU Unlock for Toyota, Scion and Lexus Models (Closed Loop)		✓	✓	✓
OE and Aftermarket TPMS Sensors and Service Kits Part Number Look-Up	✓	✓	✓	✓
Save, Manage and Edit Customer Jobs and Reports on the Cloud				✓
Retrieves, Decodes and Clears TPMS DTCs		✓	✓	✓
Tire Management, DOT, Tread Reading and More		✓	✓	✓

## Wheel Stud Tools

### 8 Piece Wheel Stud Alignment Guide Kit

SKU 818715 **41<sup>99</sup>**  
24233

- Makes the Job Faster and Easier Allowing the Tech to Safely Position the Wheel Prior to Installing the Wheel Bolts
- Applications: Mercedes-Benz, BMW, Audi, VW, Porsche, Fiat and Dodge
- Sizes Included:  
12 mm x 1.5, 12 mm x 1.25,  
14 mm x 1.25 and 14 mm x 1.75



### Wheel Stud Installers

SKU 339123 **14<sup>99</sup>**  
24234

- Works with Hubs, Rotors and Axles on Both Front and Rear Wheel Drive Vehicles
- Prevents Damage to Lug Nut or New Stud
- Designed to Fit Studs Up to 14 mm or 9/16"



### Truck Wheel Stud Installer

SKU 339117 **19<sup>99</sup>**  
24235

- Designed to Work on Truck Wheel Studs Up to 22 mm (7/8") in Diameter
- Use with an Impact Wrench or Ratchet



### Wheel Stud Installer Set for Cars and Trucks

SKU OUTSIDE BUY/EPO **24239**

- Set Includes 24234 and 24235



For Outside Buy/EPO,  
Call 901-300-4878

**OEM TOOLS**

**29<sup>99</sup>**

REG. \$34.98

**SAVE \$4**

When You Buy the Set

## AUTEL MAXITPMS

### Tesla-ready & programmable for new vehicles with Bluetooth TPMS for smarter, more connected tires

**Adjustable-Angle Sensor**  
15°-34° for a more secure fit for a broader range of vehicles.



**MaxiTPMS® MX-Sensor BLE**  
SKU 1366285  
Part #300100 **\$68<sup>00</sup>**

- Pre-programmed Bluetooth Low Energy TPMS sensors for Tesla 3/Y/S/X models
- Tesla-ready: Just Fit and Go
- Future-proof: programmable with Autel TPMS tools for the latest BLE-equipped vehicles

**MaxiTPMS® TS508 WiFi Kits**  
SKU 1328117  
Part #700180 **\$249<sup>00</sup>**

- Update software directly from tool-enabled Wi-Fi
- Quick Mode & Advanced Mode Options
- Read/Activate/Relearn All Known Sensors
- Detect & Display TPMS System Faults
- Display Vehicle-Specific Relearn Procedures; Perform OBDII Relearns
- Placard Value Reset on Supported Vehicles
- 2 Programming Options: MX-Sensors Only
- FREE Software for lifetime of tool
- 4 1-Sensors & Metal Valve Included
- SKU 1413611  
Part #700190 **\$579<sup>00</sup>**
- 20 1-Sensors Included



**MaxiTPMS® 1-Sensor**  
SKU 317455  
Part #1SENSOR **\$29<sup>95</sup>**

- Combined Frequency: 315MHz & 433MHz
- Interchangeable Valve Stems (rubber included)
- Program to Replace 99% of OE Sensors
- Fast valve stem swap



**MaxiTPMS® 1-SENSORM**  
SKU 1064478  
Part #1SENSORM **\$29<sup>95</sup>**

- Same as 1-Sensor with Aluminum stem



**MaxiTPMS® 1-Sensor 20-Pack (R)**  
SKU 370328  
Part #300010 **\$579<sup>00</sup>**

- Bulk pack of 20 1-Sensors with Rubber Valves

**MaxiTPMS® 1-Sensor 20-Pack (M)**  
SKU 1107286  
Part #300060 **\$579<sup>00</sup>**

- Bulk pack of 20 1-Sensors with Aluminum Valves



**MaxiTPMS® 1-Sensor 240 Pack**  
SKU 1089240  
Part #300050 **\$6,960<sup>00</sup>**

- Bulk pack of 240 1-Sensors with Rubber Valves

**MaxiTPMS® 1-Sensor 100 Pack**  
SKU 1128315  
Part #300070 **\$2,995<sup>00</sup>**

- Bulk pack of 100 1-Sensors with Rubber Valves

**MaxiTPMS® TS900**  
SKU 1337325 Part #TS900 **\$795<sup>00</sup>**

- Activate, Read, and Relearn ALL known TPMS sensors, including Tesla OE sensors
- Program universal Autel 1-Sensors to replace 99% TPMS sensors
- Compatible with BLE TPMS sensors and Autel BLE Sensor for Tesla vehicles
- Features Android 11 operating system and 64GB storage memory
- All Systems Diagnostics with bi-directional controls, Active Tests & Special Functions



**MaxiSYS® MS906PRO-TS**  
SKU 1207797  
Part #MS906PROTS **\$1,995<sup>00</sup>**

- AutoVIN 2006+ / AutoSCAN
- 21 Service Functions
- Wi-Fi Software Updates
- Eligible for ADAS Software Upgrade
- Advanced Coding & Adaptations

**MaxiTPMS® ITS600PRO1**  
SKU 1140847 Part #ITS600PRO1 **\$799<sup>00</sup>**

- Complete TPMS Service and Diagnostics Tablet
- 5.5 Inch Color Touchscreen/Android 9.0 OS
- Activates, Reads and Relearns All Known Sensors
- On-Tool DOT Tire Registration
- 2 MX-Sensor Program Modes

**MaxiTPMS® TBE200**  
SKU 1129878 Part #TBE200 **\$449<sup>00</sup>**

- Tire Tread and Brake Disc Wear Examiner
- Laser-Enabled; No Need to Remove Tire
- 1.65" AMOLED Super Retina, Color Touchscreen Display
- Full Color Graphical Display Illustrates Wear
- Displays Recommendations for Tire and Brake Disc Replacement, 4-wheel Alignment and Tire Rotation
- 4-megapixel, 4 cm Macro Camera and 8-megapixel Zoomable Camera to Document Tire Damage

USE TOGETHER TO CREATE A COMPLETE TPMS SYSTEM HEALTH REPORT



CALL YOUR COMMERCIAL SALES MANAGER FOR CURRENT DEALS & ORDERING

**AUTEL®**

### Inflators

OEM TOOLS®

**Digital Tire Inflator**  
SKU 802198  
24412 **69<sup>99</sup>**

- Easy-to-Read Backlit LCD Display
- 4 Units of Measure (psi, Bar, kPa, kgf)
- Measuring Range: 0 to 175 psi (0 - 12 Bar)
- Accuracy: +/-1.2 psi Up to 58 psi, +/-2.3 Between 58 psi and 145 psi Inclusive, +/-3.6 psi Greater Than 145 psi
- High Air Flow Saves the Technician Time



**Dial Tire Inflator**

SKU 301772  
24380 **59<sup>99</sup>**

- Clear and Easy-to-Read 80 mm 180 psi Gauge
- 3-In-1 Function: Inflate, Deflate and Measure Tire Pressure
- Increased Accuracy to Improve Tire Performance and Prevent TPMS Comebacks



**3.5" Digital Tire Inflator with Hose**

SKU 1268419  
AST3018 **99<sup>99</sup>**

- 21" Stainless Braided Hose
- Dual AAA Battery Powered Design
- Backlit LCD Digital Read-Out
- Includes Batteries



### Airstation

Branick

**Wall Mount Airstation**

SKU OUTSIDE BUY/EPO  
BRA155 **749<sup>99</sup>**

- Four 25' Hoses with Lock-On Chucks
- Large Easy-to-Read Digital Display
- High Flow Valve for Faster Operation
- Max Inlet Pressure: 218 psi
- Max Operating Pressure: 145 psi
- Accuracy: +/- 0.7 psi
- Increments: 1 psi



For Outside Buy/EPO,  
Call 901-300-4878

### Bead Seater

OEM TOOLS®

**5 Gallon Bead Seater**  
SKU 526505  
24449 **99<sup>99</sup>**

- Seats Beads on All Tires, from Small 4" Tires to 24-1/2" Truck Tires
- Operates on Standard Shop Air; Max. 120 psi



### Air Chuck

**Dual Foot Air Chuck with Comfort Grip Handle**

SKU 802201  
24413 **24<sup>99</sup>**

- Tilt Lock Feature Locks onto the Valve









**Air Chuck with Comfort Grip Handle**

SKU 802200  
24414 **19<sup>99</sup>**

- Sealed-Ball Air Chuck is Extended 1" from Handle to Allow Access to Tight Areas



# TIRE SERVICE

Mount/Demount Heads	Fits	Models	OE Part Number		Fits	Models	OE Part Number
<b>Red Nylon Mount/Demount Head</b> SKU 1137811 <b>39<sup>99</sup></b> SHA35034 	Hunter	TC250, TC300, TC325, TC350, TC2000, TC3250, TC3500, TC3000 and TC3100 Series	221-615-2-13	<b>Nylon Mount/Demount Head without Hardware</b> SKU 1125892 <b>44<sup>99</sup></b> SHA35033 	Accuturn	3602, 3602HP, 4260, 4560MR, 4602, 5602 and 5602 HP	2002433, 14024784
	Accuturn	(Requires Adapter) 220A, All Other Models Require 102765 Adapter	SM102529		Hofmann	1520, 1565, 1620, 1625EM, 3300, 3300EM, 1270, 2300, 3000 and 3000GP	4024784, ST0024335
	Ranger	R980X Rev A Models, R980XR/NXT, R30XLT, RX-850/950-B Models, R23/23ST, R26ST/26EX, R745 and R710 Models ONLY. Require RAN5150524 Adapter	5150523		John Bean	EHP System IVE, IV, III, IIE	2433, EAA 0247G20A
<b>Nylon Mount/Demount Tapered Hole Head with Hardware</b> SKU 1137818 <b>39<sup>99</sup></b> SHA38306 	Coats	5030, 5040, 5045, 5050, 5060, 5065, 6050, 6060, 6065, 7050, 7055, 7060, 7065, 7660, 7665, 50X, 60X, 70X, 80X, GTS, RC45, RC55, Maxx50, 70 and 80	8183061	<b>Nylon Mount/Demount Head with Hardware</b> SKU 1442589 <b>54<sup>99</sup></b> TMRTC14024784 	Accuturn	3602, 3602HP, 4260, 4560MR, 4602, 5602 and 5602 HP	2002433
	Baseline	BL200, BL300, BL400 and BL500	8183061		Hofmann	1520, 1565, 1620, 1625EM, 3300, 3300EM, 1270, 2300, 3000 and 3000GP	4024784
<b>Low Profile Mount/Demount Head</b> SKU 1125869 <b>59<sup>99</sup></b> SHA35038 	Coats	Replacement for Coats 8184432. For use on Models RC100, RC150, RC200, 5030, 5035, 5040, 5045, 5050 Series, 5060 Series, 5065 Series, 6050, 6060, 6065, 7050, 7055, 7060, 7065, 7655, 7660, 7665, BL200, BL300, BL400 and BL500	8184432		John Bean	EHP System IVE, IV, III, IIE	24335
	Coats				Snap On	All Models	24335
<b>Nylon Mount/Demount Head</b> SKU 1125877 <b>39<sup>99</sup></b> SHA35031 	Coats (Early)	5060, 50601, 5063, 5060AX, 5060EX and 9010A, 9010E, 9024E-PAX and Many RC Models	8300843	<b>Nylon Mount/Demount Head with Round Hole Kit</b> SKU 1137815 <b>99<sup>99</sup></b> SHA35030 	All Tool	All Models	2008401
	CEMB	All Models	3008403, 2008402		Coats	RC1, 5, 10, 15, 20, Early 5060, 9010, 9024 and APX90	83008402, 83008403
	Hofmann	12SE, 22SE, 1510, 1610, S410 Not for Use on Hofmann 1550, 1620 and 1625	8314813		Corghi	All Rim Clamp	250309, 450310
	Other	Fits Many Hunter TCX Series, Fits Giuliano and SICE Machines	Various		Hofmann	Earlier Models Except 1550, 1620 and 1625	8314813
				Sice	M39, S40, S42, S43, S45, S408MAXI, S435, S436 and S436TC	8314813	

## Bead Lifting Tool



### 20" Bead Lifting Tool - 3 Pack

SKU 1142616 **19<sup>99</sup>**  
26036

- For Use with Any Make of Tire Changer and Tire Combination
- Curved End to Prevent Tire Damage
- Can Be Used for Both the Removal and Mounting of Tires
- Heat-Treated for High Strength and Durability



## Rim Protectors



### 12 Pack Plastic Insert Rim Protectors for Coats Stainless Steel Mount/Demount Head

SKU 1400044 **19<sup>99</sup>**  
TMRT1182963

- For Coats Stainless Steel Mount/Demount Head Coats 8182961 (2 Pk.) RC1, 5, 10, 15, 20 8182963 (12 Pk.) Early 5060, 5030, 5040, 5050, 5060, 5065 5070, 6050, 6060, 6065, 7050, 7055, 7060 7065, 7655, 7660 and 7665



## Hybrid Duckhead Tail - 2 Pack



SKU 1442586 **44<sup>99</sup>**  
AMM8560896102

- Designed to Float Across the Rim, Decreasing the Stretching of the Bead
- Compatible with Hybrid Duckhead® Mount/Demount Tool (85608959)
- Compatible with All X-Series and RC Series That Have Hybrid Duckhead® Mount/Demount Tools





# TIRE SERVICE

TO ORDER, contact your Commercial Sales Manager or go to [AutoZonePro.com](http://AutoZonePro.com)

TIRE SERVICE

## Non-Marring Lug Nut Sockets

### 1/2" Drive 17 mm Mercedes-Benz® Flower Lug Bolt Impact Socket

SKU 081308 **13<sup>99</sup>**  
24469

- Designed Specifically for 17 mm, Convex "Flower" Shaped Mercedes Lug Bolts



### 3 Piece Extra Thin-Wall Wheel Nut Protector Impact Socket Set

SKU 094646 **24<sup>99</sup>**  
25583

- Blue - 17 mm/11/16", Gold - 19 mm/3/4" Red - 21 mm/13/16"

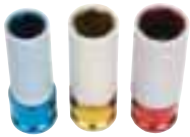

### 3 Piece Super Strength Wheel Nut Impact Socket Set

SKU 347212 **29<sup>99</sup>** REG. \$39.99  
24227

- Blue - 17 mm/11/16" Gold - 19 mm/3/4" Red - 21 mm/13/16"

**SAVE \$10**



Offer Good While Supplies Last Through June 30, 2025

OEM TOOLS®

### 9 Piece Thin-Wall Wheel Protector Impact Socket Set

SKU 965856 **74<sup>99</sup>**  
24224

- Sizes: 3/4", 7/8", 13/16", 15/16", 1", 1-1/16", 17 mm, 19 mm and 21 mm



### 1/2" Drive Non-Marring Lug Nut Socket Set

SKU OUTSIDE BUY/EPO **29<sup>99</sup>**  
68945

- Serves 17 mm, 19 mm, 21 mm and 22 mm Lug Nuts
- Non-Marring Sleeve Prevents Damage of Lug Nuts and Wheel Rims
- CR-MO Steel Construction for Strength and Durability



For Outside Buy/EPO, Call 901-300-4878

## Lug Nut Sockets

OEM TOOLS®

### Master Lug Nut Kit

SKU 1190208  
68919

- Includes: 2 Socket Sets for Removing, Locking, Damaged and Undamaged Lug Nuts on Most Vehicles
- Ideal for Removal of Warped and Mangled Chrome-Cap Style Lug Nuts
- Easily Removes Locking Lug Nuts on Most Aftermarket Wheels



**89<sup>99</sup>**

REG. \$109.98

**SAVE OVER \$19**

When You Buy the Kit

### 16 Piece Locking Lug Master Key Set

SKU 626107 **79<sup>99</sup>**  
24447

- Easily Removes Locking Lug Nuts on Most Aftermarket Wheels
- Thin-Wall Sockets Prevent Damaging Wheels and Lugs
- Hex-Head Design Fits Most Lug Wrenches as well as 13/16" and 7/8" Sockets



### 4 Piece Deep Thin-Wall SAE and Metric Impact Flip Socket Set

SKU 965857 **29<sup>99</sup>**  
24223

- Includes: 3/4" to 13/16", 19 mm to 21 mm and 7/8" to 15/16" Sockets and 3" Extension



### 5 Piece 1/2" Drive Flip Socket Set

SKU 1125891 **29<sup>99</sup>**  
25555

#### Half Metric Sizes for Removal of Warped and Mangled Chrome-Cap Style Lug Nuts

- Durable CR-MO Flip Socket Set
- Includes: 18.5 mm x 19.5 mm, 19 mm x 21 mm, 21 mm x 21.5 mm, 22 mm x 22.5 mm and 1/2" Drive Extension



## Tire Service Tools

### 2 Piece Tire Valve Core Tool Set

SKU 1209377 **12<sup>99</sup>**  
22589

- Designed for Removal and Installation of Schrader Style Valve Cores
- Includes: 2" and 5" Tools
- Extra-Long 5" Tool for Hard-to-Reach Applications
- Tough Impact and Solvent-Resistant Acetate Handle

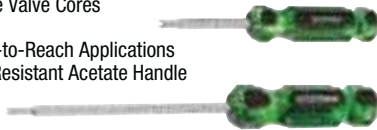

OEM TOOLS®

### Quick Change Wheel Stud Cleaner Kit

SKU 666299 **69<sup>99</sup>**  
CAL16

- Kit Includes: 1/2" Drive Adapter and 6 Brushes
- Brush Sizes: 7/16" (12 mm), 1/2" (13 mm), 9/16" (14 mm), 5/8" (16 mm), 7/8" (22 mm) and 1-1/8" (28 mm)



CAL16

### Spare Tire Removal Set

SKU 749919 **69<sup>99</sup>**  
24219

- 32" Reach Allows Access to Spare Tires Stored on the Undercarriage of Pickups, Vans and SUVs
- Includes: 6 Zinc-Plated Steel Attachments That Fit a Range of Vehicle Types, Hand Crank and Heavy Duty Nylon Pouch
- No Additional Tools Needed

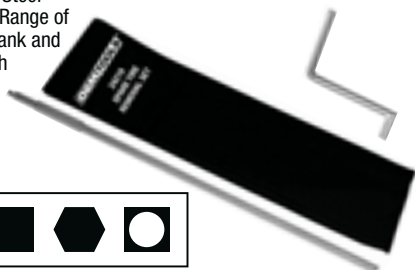

Attachments Included



OEM TOOLS®

### Tire Tube Test Tank

SKU 291382 **109<sup>99</sup>**  
LIS19822

- Tank Features Reinforcement Ribs for Extra Support
- Will Handle Passenger Tire Sizes to Wide Oval and Light Duty Truck Tires
- Dimensions: 31" (L) x 12" (W) x 12" (H)



Lisle

### 5025 Tire Spreader

SKU 757051 **429<sup>99</sup>**  
BRA00-0161

- Self-Locking Spread Arms
- 4 Horizontal and 2 Vertical Adjustments
- Handles Any Passenger Tire, Including Low Profiles
- Quick Pin Adjustment with Lanyard



Branick

Prices subject to change without notice. Prices do not include applicable taxes, vehicles, tires, rims, installation or optional equipment as shown. Please do not return purchases to the store. For information regarding warranty, repair, or any questions or concerns, call 901-300-4878.

AZG0225

105

# TIRE SERVICE



## TPMS SAVINGS



### EZ-sensor Multi-pack Options

**4 Pack #33500-4**  
SKU #932751

**12 Pack #33500-12**  
SKU #810811

**50 Pack #33500-50**  
SKU #1097944

**100 Pack #33500-100**  
SKU #1096382



EZ-sensor® is the market-leading OE quality, programmable, single SKU TPMS solution.

Schrader's EZ-sensor® family of products can be programmed to service the majority of vehicles!

**EZ-sensor® is compatible with most industry programming tools.**

### Tool and Sensor Bundle #21324AZ

SKU #1232018

**S41**  
5 YEARS OF SOFTWARE INCLUDED!



Includes S41 Tool and 16 EZ-sensors®  
**399<sup>99</sup>**

#### Benefits:

- Exclusive EZ-sensor® programming
- Built-in OBDII module and quick connect cable
- Full color screen
- Allows placard pressure change

**CALL YOUR COMMERCIAL SALES MANAGER TO ORDER YOUR WHEEL WEIGHTS TODAY**

### Wheel Weight Kits

- Steel Weights are More Environmentally Friendly Compared to the Lead Weight Alternative
- Premium Powder Coated Finish Resists Chips and Scratches Which Helps Prevent Damage and Corrosion to Wheels

#### Complete Wheel Weight Kit with Floor Rack

SKU 1392466  
68953A

- Includes 78 Boxes of Coated Clip-On Wheel Weights
- ALFE, LHFE, MCFE, PFE, TFE, ENFE, FNFE and IWFE
- 25 Weights per Box
- All Metal Floor Rack



- ALFE Steel
- LHFE Steel
- MCFE Steel
- PFE Steel
- TFE Steel
- ENFE Steel
- FNFE Steel
- IWFE Steel

**1,049<sup>99</sup>**  
REG. \$1,609.21

**SAVE OVER \$559**  
When You Buy the Kit

#### Adhesive Wheel Weight Starter Kit with Stand

SKU 1392467  
68955A

- Includes: 4 Boxes and 2 Rolls of Adhesive Wheel Weights
- 3 Boxes of Strips, .25 Oz, .50 Oz. and 1.00 Oz.
- 1 Box of .25 Oz. Strips, Black
- (2) 10 Lb. Rolls of .25 Oz. and .50 Oz.
- Wheel Weight Dispenser Stand



**349<sup>99</sup>**  
REG. \$511.93

**SAVE OVER \$161**  
When You Buy the Kit

### Wheel Weights Only



#### Complete Wheel Weight Kit, Weights Only

SKU 1392468  
68954A

- Includes 78 Boxes of Coated Clip-On Wheel Weights
- ALFE, LHFE, MCFE, PFE, TFE, ENFE, FNFE and IWFE in the Most Popular Sizes
- 25 Weights per Box

- ALFE Steel
- ENFE Steel
- LHFE Steel
- FNFE Steel
- MCFE Steel
- IWFE Steel
- PFE Steel
- TFE Steel

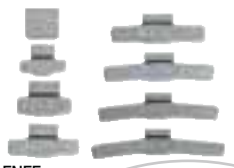

**649<sup>99</sup>**  
REG. \$1,209.22

**SAVE OVER \$559**  
When You Buy the Kit

#### Wheel Weight Starter Kit, Weights Only

SKU 1392326  
68952

- Includes: 18 Boxes of Coated Clip-On Wheel Weights
- ALFE, MCFE and PFE in the Most Popular Sizes
- 25 Weights per Box

- ALFE Steel
- MCFE Steel
- PFE Steel

**149<sup>99</sup>**  
REG. \$231.82

**SAVE OVER \$81**  
When You Buy the Kit

#### Adhesive Wheel Weight Starter Kit

SKU 1525567  
68956

- Includes: 4 Boxes and 2 Rolls of Adhesive Wheel Weights
- 3 Boxes of Strips, .25 Oz, .50 Oz. and 1.00 Oz.
- 1 Box of .25 Oz. Strips, Black
- (2) 10 Lb. Rolls of .25 Oz. and .50 Oz.



**199<sup>99</sup>**  
REG. \$361.94

**SAVE OVER \$161**  
When You Buy the Kit

#### Wheel Weight Starter Kit with Floor Rack

SKU 1339729  
OEMREPLENKITA

- Includes: 18 Boxes of Coated Clip-On Wheel Weights
- ALFE, MCFE and PFE in the Most Popular Sizes
- 25 Weights per Box
- All Metal Floor Rack

- ALFE Steel
- MCFE Steel
- PFE Steel

**549<sup>99</sup>**  
REG. \$631.81

**SAVE OVER \$81**  
When You Buy the Kit

Prices subject to change without notice. Prices do not include applicable taxes, vehicles, tires, rims, installation or optional equipment as shown. Please do not return purchases to the store. For information regarding warranty, repair, or any questions or concerns, call 901-300-4878.



# TIRE SERVICE

## Torque Limiting Set

### 8 Piece Torque Limiting Extension and Thin Wall Socket Set

SKU 347217 **79<sup>99</sup>**  
24228

- 4 Extension Bars: 65Ft/Lb. (90Nm), 90 Ft/Lb. (120 Nm), 100 Ft/Lb. (135 Nm) and 110Ft/Lb. (150 Nm)
- 4 Deep Sockets: 17 mm, 19 mm, 21 mm, 22 mm



### 5 Piece 1/2" Drive Torque Limiting Extension Set

SKU 965858 **49<sup>99</sup>**  
24220

- Quick, Simple and Accurate
- Helps Prevent Lug Stud/Nut Damage and Warped Rotors
- Includes 1/2" Drive Extensions: 65 Ft/Lb., 80 Ft/Lb., 100 Ft/Lb., 120 Ft/Lb. and 140 Ft/Lb.
- Made with Flexible Chromoly Steel that Stops Turning When the Required Torque is Reached
- Comes in a Sturdy Blow Mold Case



## Torque Wrenches

### 3/8" Drive 10-80 Ft/Lb.

SKU 177722 **59<sup>99</sup>**  
25694

### 1/2" Drive 10-150 Ft/Lb.

SKU 012651 **69<sup>99</sup>**  
25689

### 1/2" Drive 25-250 Ft/Lb.

SKU 177715 **99<sup>99</sup>**  
25695



### 1/2" Drive Undercar Torque Wrench

SKU OUTSIDE BUY/EPO **329<sup>99</sup>**  
CEN97354A



- Unique One-Way Design Cannot Be Used as a Breaker Bar (thus Preventing Damage)
- High Contrast Laser Markings for Easier Reading
- Rubber Over-Mold Lock Ring for Better Grip
- Head and Handle Covers for Increased Durability
- Range: 25 to 250 Ft/Lb. (43.4 to 348.4 Nm)
- Length: 23.3"



For Outside Buy/EPO, Call 901-300-4878

## Tire Repair

### Puncture Repair Set

SKU OUTSIDE BUY/EPO **179<sup>99</sup>**  
XTS14-662

- Includes Puncture Repair Procedures Guide and 20" x 32" Shop Poster
- Enough Supplies to Provide More Than 70 Complete Repairs



For Outside Buy/EPO, Call 901-300-4878

### Tire Repair Cabinet Assortment

SKU OUTSIDE BUY/EPO **649<sup>99</sup>**  
XTS14-603

- Deluxe Wall-Mount Cabinet
- Loaded to Complete Over 110 Industry Standard Puncture Repairs
- All the Tools Plus XLIGHT Air Powered Vacuum Carbide Cutters and More



For Outside Buy/EPO, Call 901-300-4878

### 11" Cotton Tire Swab (6 Pack)

SKU 666324 **21<sup>99</sup>**  
XTS14-378PK

- Professional Quality Tire Repair Tool
- Use to Spread Mount/Demount Lube on Bead of Tire

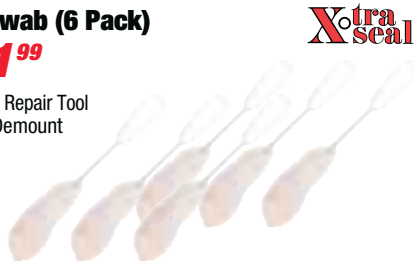

### Mounting/Demounting Compound (2 Pack)

SKU OUTSIDE BUY/EPO **49<sup>99</sup>**  
XTS14-708EPK

- Very Slippery
- No Mixing or Water Required
- Dries Tacky
- Rust Inhibitors
- Works Great with Low Pro, Run Flat and Alloy Wheel Applications
- Mounting and Demounting Compounds to Prevent Damage to Tire Bead



For Outside Buy/EPO, Call 901-300-4878

### Xtra Slick Tire Bead Lube (2 Pack)

SKU 1281603 **23<sup>99</sup>**  
XTS14-753PMPK

- Ready-to-Use Mounting and Demounting Compounds to Prevent Damage to Tire Bead
- Pre-Mixed



### 8 Oz. Vulcanizing Cement (3 Pack)

SKU 666342 **24<sup>99</sup>**  
XTS14-008PK

- Fast Drying
- Can Be Used with Heat Vulcanization



### Tire Buffing Cone

SKU 1142704 **15<sup>99</sup>**  
24479

- Tungsten Carbide Wheel for Fast and Effective Surface Preparation
- 3/8" Quick Disconnect Arbor
- Max. RPM: 5,000



### 57 Piece Tire Repair Kit

SKU 213119 **29<sup>99</sup>**  
26686

- Includes: T-Handle Plug Insert Tool, T-Handle Reaming Tool, Replacement Insert Needle, Long Nose Pliers, Hex Keys, 30 Repair Plugs, Utility Knife, Lubricant, Valve Cores, Valve Caps, Valve Stems and a Valve Core Tool



### Refill Plugs for Any OEMTOOLS® Tire Repair Kit

#### Repair Plug Refill Sets

- For Use with 26680, 26682, 26683 and 26686

#### 30 Pack

SKU 477063 **8<sup>99</sup>**  
26684

#### 100 Pack

SKU 477176 **14<sup>99</sup>**  
26685

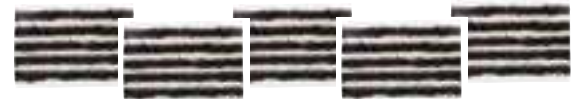

# BRAKE SERVICE

FOR HELP with Selection, Confirm Availability and Ordering Instructions, Call 901-300-4878

BRAKE SERVICE

## Brake Lathe Kit



### Combination Bench Lathe Kit

SKU OUTSIDE BUY/EPO **13,449<sup>99</sup>**  
PCTB-17K

- Features Adapters and Accessories for All Passenger Vehicles and Light Trucks
- Resurfaces Brake Drums and Discs to Exceed OEM Specs for Surface Finish in 1 Pass
- Switch from Drums to Rotors in Seconds
- Includes: Dust Collection System and Side Work Table

On-Site Installation and Training Included

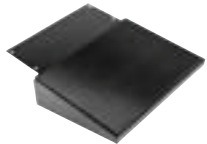

PCT50-4720



PCT50-4280



PCTB-17K

WARRANTY: 1 Year Parts and Labor

**BONUS VALUE: \$1,099.99**



### Quick Chuck Kit

PCT50-4250K

With Purchase of PCTB-17K

Offer Good While Supplies Last Through June 30, 2025

## Lathe Kit with Trolley



### On Car Brake Lathe for Car and Light Truck

SKU OUTSIDE BUY/EPO **15,299<sup>99</sup>** REG. \$16,449.99  
PCTX15-6ADP

- Plug In, Variable Speed 48v DC Motor
- Performance Plus Cutting Head
- New PFM 2.0 Electronics
- Patented One Touch Lateral Run Out (LRO) Compensation
- Cross Platform Compatible Computer and Wiring Harness
- 6 LED On-Board Work Light
- 4 Wheel, 4 Axis, Adjustable Trolley

SAVE **\$1,150**

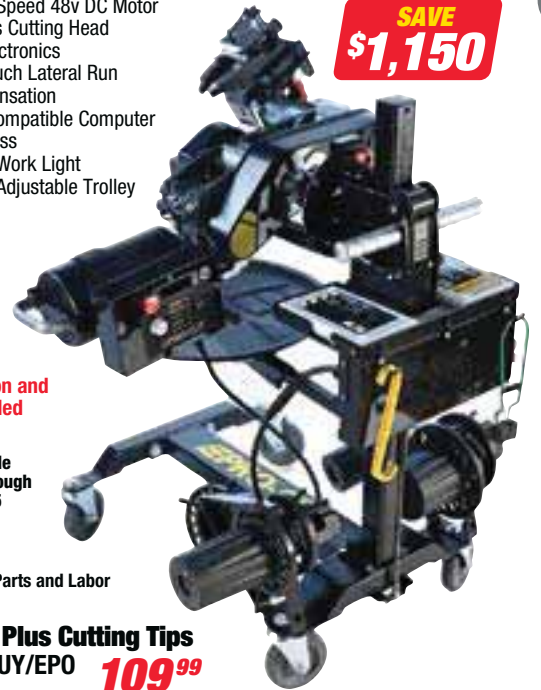

On-Site Installation and Training Included

Offer Good While Supplies Last Through June 30, 2025

WARRANTY: 2 Year Parts and Labor

### Performance Plus Cutting Tips

SKU OUTSIDE BUY/EPO **109<sup>99</sup>**  
PCT50-778

- Includes: 6 Tips with Screws

TEST DRIVE BEFORE YOU PURCHASE!

901-300-4878

## Ranger®

### RL-8500 Combination Brake Lathe with Bench and Standard Tooling

SKU OUTSIDE BUY/EPO **9,099<sup>99</sup>**  
RANRL8500

- Complete Kit Includes Lathe, Standard Adapters and Bench
- Provides a Faster, More Accurate and Easier Resurfacing Capability Than Any Other Brake Lathe in Its Class
- Infinitely Variable Speed Controller Able to Turn Rotors and Drums
- Quick-Change Adapter-Plus System with Built-In Springs Eliminates the Need for Conventional Bell Clamps and Cones
- Independent DC Servo Motors Control the Cross-Feed and Spindle-Feed Drives
- One-Cut Micro Finish
- 150 or 200 RPM Spindle

### RL-8500XLT HD Combination Brake Lathe with Bench and Standard Tooling

SKU OUTSIDE BUY/EPO **10,499<sup>99</sup>**  
RANRL8500XLT

WARRANTY: 1 Year Parts and Labor

Leasing Terms Available, Ask Your AutoZone® Commercial Sales Manager.



RANRL8500

Shown with Optional Equipment. Accessories Not Included.



### Truck Adapter Package

SKU OUTSIDE BUY/EPO **2,299<sup>99</sup>**  
RAN510161

- Super-Duty Truck Tooling Package Consists of an Upgraded 1-7/8" Arbor and a Wide Variety of Adapters
- 32 Piece Set Allows Expanded Coverage to Handle Any Vehicle Up to 1 Ton Trucks
- Fits RL-8500 and RL-8500XLT



Customer Responsible For Offloading, Liftgate Service Available.

For Outside Buy/EPO, Call 901-300-4878

Prices subject to change without notice. Prices do not include applicable taxes, vehicles, tires, rims, installation or optional equipment as shown. Please do not return purchases to the store. For information regarding warranty, repair, or any questions or concerns, call 901-300-4878.

AZG0225

109

# BRAKE SERVICE

## Brake Service Tools

### 2 Piece Steel Line Stopper Set

SKU 1331483 **19<sup>99</sup>**  
35057

- Seals Steel Lines Found on Fuel, Brake, AC, Power Steering, Transmission Cooling Lines and Banjo Lines
- Prevents Leaks and Contamination
- For Use with All Automotive Fluids
- Fits 3/8", 1/2", 5/16" and Banjo Lines



### 8 Piece Brake Tool Set

SKU 900827 **49<sup>99</sup>**  
27194 REG. \$57.99

**SAVE \$8**

- Includes: Spring Compressor, Brake Spring Installer, Spring Removal Tool, Brake Retaining Spring Tool, Brake Spring Pliers, 2 Brake Adjustment Spoons and Mini Adjustment Spoon

Offer Good Through June 30, 2025

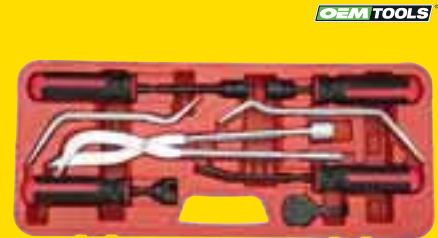

### Brake Cylinder Retainer Remover

SKU 265111 **14<sup>99</sup>**  
25268

- Expands and Holds Special Retainer So the Brake Cylinder May Be Removed
- Releases the Spring Clip Retainer That Attaches the Rear Brake Cylinder to Backing Plate



### 8 Piece Brake Caliper Hanger Set

SKU 312538 **27<sup>99</sup>**  
24518

- Prevents Kinking or Premature Failure of Brake Hose
- Keeps Calipers Up and Out of the Way When Servicing Suspension Components, Brakes, etc.
- Hi-Vis Green Powder Coat So You Won't Misplace Them or Leave Them Attached to the Vehicle



### 8 Piece Manual Brake Gauge Set

SKU 191672 **14<sup>99</sup>**  
25266

- Color Coded Brake Gauge Identifies Thickness Levels for Brake Lining Inspection
- Includes Sizes: Red: 2, 3 mm, Yellow: 4, 5, 6 mm, Green: 8, 10, 12 mm
- Red Indicates Must Be Serviced; Yellow Indicates Should Be Serviced; Green Indicates Good



### Brake Caliper Brush

SKU 250125 **14<sup>99</sup>**  
25435

- Slim Design for Cleaning Brake Calipers and Other Brake Hardware



### Multi-Purpose Tubing Bender

SKU 390889 **18<sup>99</sup>**  
25179

- Lightweight for Easy Handling
- Makes Left, Right and Offset Bends Up to 90°
- Degrees Marked for Accuracy
- Use with 1/4", 5/16" and 3/8" (4, 6 and 8 mm) Diameter of Mild Steel and Soft Tube Material



### 1/2" Drive Impact Driver Set

SKU 1142387 **27<sup>99</sup>**  
22561

- Easily Break Free Rusted, Corroded and Frozen Screws
- Includes: Impact Driver, Bit Adapter, 8 Impact Bits and Sturdy Blow Mold Case



### Rotor/Drum Caliper Kit

SKU 186504 **109<sup>99</sup>**  
CEN3K301

- Attaches to Any Caliper on the Lower Jaws
- Outward Facing Anvils to Inspect Drums
- Inward Pointing Anvils to Measure Rotors 8" to 13"
- Range 0 to 6" Digital Caliper Included



### Electronic Digital Rotor Gage

SKU 1330687 **99<sup>99</sup>**  
CEN3M431

- Easy to See Digital Readout
- Long Arms for All Rotors
- Interchangeable Flat and Pointed Anvils



### Disc Brake Rotor Micrometer

SKU 607071 **59<sup>99</sup>**  
25367

- .001" Accuracy, .0005" Reading
- Large LCD Display with SAE or Metric Reading
- Manual Power Off/On
- Range: 5.5"/140 mm
- Easy Glide Action
- Hardened Measurement Surface



## Carbide Lathe Inserts



SKU	Part Number	Quantity	Application	Description	OEM Part No.	Price
262385	SHA0626	6 Pack	Ammco	Use on Ammco Models 1000, 1001, 3000, 4000, 4100, 7000, 7700	90614-6	<b>19.99</b>
262386	SHA06210	10 Pack	Ammco	Use on Ammco Models 1000, 1001, 3000, 4000, 4100, 7000, 7700	90614-10	<b>29.99</b>
262389	SHA06810	10 Pack	Accu-turn/Bosch	Use on Accu-Turn, Bosch On-The-Car Brake Lathe Models 8700, 8750 and 8800	433796, 878051, 080-80000-68	<b>49.99</b>
262388	SHA1046	6 Pack	Ammco	Positive Rake Cutting Bits for Ammco Models 3850, 4000, 7000 and 7500 as well as Twin Cutter and 9381 Facing Set	906918-6	<b>49.99</b>
543384	SHA069-10	10 Pack	Pro-Cut	Pro-Cut Style Bit for Use on Model 610 On-The-Car Lathes for Ford. RJ West PFM 9.2, FM900, PFM 9.2DRO Warthog and 9.2DRO	50-742	<b>64.99</b>
262382	SHA40710	10 Pack	FMC	Use on FMC, John Bean, Barrett, Snap-On 67BSD, 67DLX, 67GSA, 69DLX, 701ECF, 601PF, 400, 500, 600, 700 Disc/Drum Lathes	90488, W139, D139	<b>54.99</b>
262409	SHA80210	10 Pack	Kwik Way	Use on All Kwik-Way and Snap-On SDL, DL, 850 Disc Lathes, Rotunda, Snap-On On-The-Car YA180, YA 281 Bench Lathes	109-1092-23, 109-1092-45, BTK10A	<b>79.99</b>
300786	SHA408-10	10 Pack	FMC/Ranger/Accu-turn	Ranger RL8500 and RL8500XLT Disc and Drum Cutting Lathes. FMC/Barrett Models 400, 500, 600 and 700 Lathes	45016	<b>84.99</b>
262383	SHA06010	10 Pack	Accu-turn	Use on Models: 7700, 8920, 8922, 8944, 8989, 8990, 8991, 8993, 8995 and 8997 Brake Lathes. 3 Cutting Edges	433796	<b>59.99</b>
1142331	SHA065-10	10 Pack	Hunter	Use on Rotor Models: BL500, 501 and 505 Hunter Lathes	221-639-3	<b>89.99</b>

## Silencer Bands



### Large Solid Rotor Silencer Band (9")

SKU 262396 **14<sup>99</sup>**  
SHA94



### Small Solid Rotor Silencer Band (6")

SKU 262393 **14<sup>99</sup>**  
SHA96

### Silencer Clamp

SKU 388821 **64<sup>99</sup>**  
SHA70B



### Ammco Style Disc Silencer Band with Steel Weights

SKU 262392 **44<sup>99</sup>**  
SHA69



### Ammco Style 1-3/4" Drum Silencer Band

SKU 262390 **64<sup>99</sup>**  
SHA80B



### Ammco Style Large Disc Silencer Band with Steel Weights

SKU 262397 **84<sup>99</sup>**  
SHA930



See [AutoZonePro.com](http://AutoZonePro.com) for More Applications

Prices subject to change without notice. Prices do not include applicable taxes, vehicles, tires, rims, installation or optional equipment as shown. Please do not return purchases to the store. For information regarding warranty, repair, or any questions or concerns, call 901-300-4878.

# BRAKE SERVICE

TO ORDER, contact your Commercial Sales Manager or go to [AutoZonePro.com](http://AutoZonePro.com)

BRAKE SERVICE

## Brake Bleeding Tools

OEM TOOLS

### Vacuum Pump Tester, Power Steering and Brake Bleeder Kit

SKU 1103570 **39<sup>99</sup>**  
37070

- Includes: Vacuum Pump Reservoir Jar with Transfer Lid, Storage Lid, Brake Bleeding Adapter Package, Steering Pump Adapters and Tubing Pump with Vacuum Gauge and Accessories



### 1 Liter Pneumatic Vacuum Brake Bleeder with Refill Bottle

OEM TOOLS

SKU 1282750 **47<sup>99</sup>**  
22505

- Convenient Single-Person Operation
- Effective for Use on Disc/Drum Brakes and Clutches
- Auto-Refill Kit to Simplify the Master Cylinder Refill
- Uses a Standard Workshop Air Supply



### Universal Fluid Dispensing Bottle

OEM TOOLS

SKU 568477 **39<sup>99</sup>**  
24443

- Refill the Master Cylinder During Vacuum or Manual Hydraulic Brake or Clutch Bleeding and Flushing
- Mounts Securely to Master Cylinder and Clamps
- Capacity: 50 Oz.



**BONUS VALUE: \$9.99**

### Brake Bleeder Wrench (8 and 10 mm)

25317

With Purchase of: 24443

Offer Good While Supplies Last Through June 30, 2025

### 2 Liter Pneumatic Vacuum Brake Bleeder with Refill Bottle

OEM TOOLS

SKU 1361989 **59<sup>99</sup>**  
22506 REG. \$69.99

- For Use on Brakes and Hydraulic Clutches
- Convenient Single-Person Operation
- Uses Standard Workshop Air Supply
- Includes: Auto-Refill Kit to Simplify the Master Cylinder Refill and Adapters to Fit Most US and Domestic Vehicles
- Standard and ABS Brake Systems

**SAVE \$10**



### DIY Reverse Brake and Clutch Bleeder

DIY REVERSE SYSTEMS

SKU 459112 **64<sup>99</sup>**  
PHO2104-B

- Easily Bleeds ABS
- Removes Trapped Air
- Attachments to Fit All Vehicles



### Master Cylinder Adapter Cap Update Kit

Mityvac

SKU OUTSIDE BUY/EPO **269<sup>99</sup>**  
MITMVA6855

- Includes Adapter Caps: (2) Honda Specific Caps, (1) Tesla Specific Cap, (1) Nissan / Infinity Hybrid Specific Cap, (2) Ford Caps, (1) Ford / Tesla Specific Cap, and 3 Down Tubes for Caps
- EV/Hybrid
- Update Cap Kit Combined with MVA6850 Covers Most Hybrid and Electric Vehicle Brake Pressure Bleeding Applications
- Expands Our Cap Offerings for Brake Bleeding
- Can Be Used with All MityVac Manual and Pneumatic Pressure Pumps



For Outside Buy/EPO, Call 901-300-4878

### 1.3 Quart Vacuum Brake Bleeder

Mityvac

SKU 459166 **149<sup>99</sup>**  
MITMV6870

- 1.3 Quart Reservoir
- Applications: Brake Bleeding, Hydraulic Clutch Bleeding
- Universal Bleed Screw Adapter Fits Most Common Sizes
- Includes Two Replacement Bleed Screw Adapters



### Silverline Elite Test Kit

Mityvac

SKU 988888 **139<sup>99</sup>**  
MITMV8500

- Provides Either Vacuum or Pressure with Equal Precision and Convenience
- Performs Engine Performance Diagnostics, Brake Bleeding, Fluid Transfer, Evacuation, Sampling and More
- Includes Components Needed to Perform Hundreds of Diagnostic and Mechanical Tests



### Brake Bleeding Kit

Mityvac

SKU 604208 **239<sup>99</sup>**  
MITMV6830

- Compressed Air Operation
- 1.9 Quart Capacity
- Swivel Air Inlet with Quick Disconnect



### Pressure Brake Bleeding System

Mityvac

SKU 383099 **519<sup>99</sup>**  
MITMV6840

- Large 1.2 Gallon Capacity Dispenser
- Includes 7 Master Cylinder Adapters That Connect to Most U.S., Asian and European Cars and Light Trucks
- Pressure Gauge Indicates Dispensing Pressure
- Utilizes Push-to-Connect, Quick-Change Adapters
- Integrated Manual Relief Valve for Safety



### 2.5 L Pressure Brake Bleed Kit

Mityvac

SKU 1361996 **574<sup>99</sup>**  
MITMV7840

- Utilizes Shop-Air to Produce Pressure for Dispensing and Vacuum for Extracting
- Pressure Control System Safely Maintains Output Pressure Between 20 and 25 psi
- Includes 7 Master Cylinder Adapters That Connect to Most Domestic and Import Cars and Light Trucks
- Conveniently Located On/Off and Flow Control Valve



### 5 Piece Brake Bleeder Wrench Set

VIM

SKU 1442597 **59<sup>99</sup>**  
VIMBB500

- Includes: 7 mm to 11 mm
- True Size Hex Openings for Tight Fit
- Satin Chrome Plated High Alloy Steel
- Angles are Designed to Access Bleeder Screws without Removing the Wheel

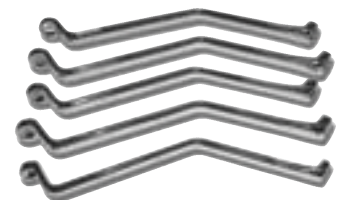

Prices subject to change without notice. Prices do not include applicable taxes, vehicles, tires, rims, installation or optional equipment as shown. Please do not return purchases to the store. For information regarding warranty, repair, or any questions or concerns, call 901-300-4878.

AZG0225

111

# BRAKE SERVICE

## Disc Brake Tools

OEM TOOLS

### 18 Piece Disc Brake Caliper Set

SKU 94798 27113 **42<sup>99</sup>**

- Includes Caliper Adapters from 1-3/16" to 2-1/2" – Some Specifically to Service Nissan, Saab and Honda Models
- Includes Right and Left Hand Caliper Rotation Tools
- Left Hand Thread is Useful When Working on 2004-2007 Ford Freestyle, 500, 2008 Taurus and Taurus X Models
- Rust Resistant Finish



### 37 Piece Disc Brake Service Kit

SKU 1125858 25107

- Includes: Disc Brake Caliper Tool Set, Pad Spreader, Brake Caliper Brush, 8 Brake Caliper Hangers, 3 Bleeder Wrenches and One-Man Brake Bleeder Kit

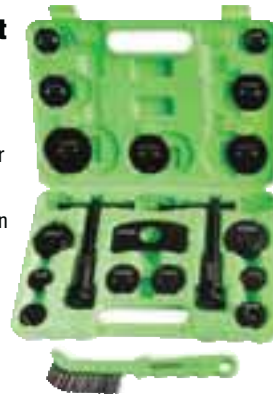

OEM TOOLS

**69<sup>99</sup>**

REG. \$156.92

SAVE \$86 OVER

When You Buy the Kit

### Pneumatic Brake Caliper Tool Set

SKU 1053954 MSC43050 **219<sup>99</sup>**

- Durable Non-Impact Single Piston Shaft
- O-Ring Protected Shaft to Maintain Proper Pressure
- Magnetic Base to Secure Press Adapters
- 15 Piece Press Adapter Set



Mastercool  
World Class Quality

### Dual Piston Press

SKU 900811 25741 **54<sup>99</sup>**

- Designed to Press-In Single and Dual Piston Brake Calipers
- Universal Application on Cars, Light and Heavy Trucks
- Rugged Design for Longer Tool Life

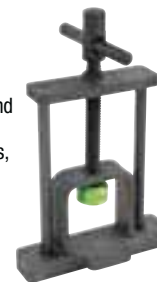

OEM TOOLS

### Dual Speedy Pad Spreader

SKU 291420 LIS25750 **84<sup>99</sup>**

- Compresses Dual Brake Pistons Simultaneously
- Makes Dual Piston Pad Replacement a Simple Job



Lisle

### Speedy Pad Spreader

SKU 291417 LIS24300 **64<sup>99</sup>**

- Compresses Disc Brake Pistons in Seconds
- Makes Brake Pad Replacement Easier



Lisle

### Quick Quad Pad Spreader

SKU 080553 LIS29100 **109<sup>99</sup>**

- A Quick Way to Spread Brake Pads and Compress Disc Brake Pistons for Pad Replacement on Single, Double and Quad Piston Calipers
- Simultaneously Compress All 4 Pistons on Quad Piston Applications
- Can Be Used While Caliper is on the Vehicle or Hanging Free



Lisle

### Brake Caliper Press (Standard Size)

SKU 954224 LNG279 **99<sup>99</sup>**

- Size Range is 1.7" to 3"
- Works on Various Single, Dual and Quad Piston Calipers
- 360° Ratchet Swing Allows Access at Any Angle



LANG

### Brake Caliper Press (Small Size)

SKU 1400043 LNG277 **89<sup>99</sup>**

- Size Range is 1" to 2.25"

### Brake Caliper Piston Rewind Tool

SKU 1368620 35058 **44<sup>99</sup>** REG. \$54.99

- Includes a Standard Two-Pin Adapter Compatible with Any Piston Adapter
- Includes a Fully Adjustable 3/8" Drive 2 and 3 Pin Adapter Tool That Fits Most Vehicles
- Powerful Internal Spring to Apply Stable Pressure to the Caliper Piston

SAVE \$10



OEM TOOLS

Offer Good While Supplies Last Through June 30, 2025

### Brake Hub Resurfacing Tool

SKU 013590 24686 **15<sup>99</sup>**

- Quickly Remove Rust on Lug Studs and Rotors on the Hub Assembly
- Use with Drill for a Quick and Easy Job
- Fits All Passenger Cars, Light Trucks and SUVs
- Includes 4 Pads



OEM TOOLS

**BONUS VALUE: \$19.99**

### Large Replacement Pads - 5 Pack

65688

- Replacement Brake Hub Resurfacing Pads for 24686 Includes (5) 2" Pads



With Purchase of: 24686

Offer Good Through June 30, 2025

### 2 and 3 Pin Brake Rewind Tool

SKU 13592 24693 **24<sup>99</sup>**

- 2 Fully Adjustable to Fit Thousands of Vehicles
- No Need for Multiple Tools
- 3/8" Drive Adapters

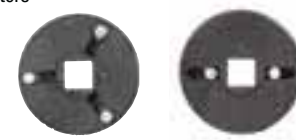

3 Pin Side

2 Pin Side

OEM TOOLS



# BRAKE SERVICE

TO ORDER, contact your Commercial Sales Manager or go to [AutoZonePro.com](http://AutoZonePro.com)

BRAKE SERVICE

## Sprayers

### Red Powder Coated Aluminum Sprayer

SKU 186463  
MSMB8000PL **46<sup>99</sup>**

- 16 Oz. Capacity
- Not for Use with Chlorinated Solvents
- Pressurize Up to 200 psi

### Complete Repair Kit for B8000PL

SKU 186467  
MSMBK50 **29<sup>99</sup>**



### Red Powder Coated Steel Sprayer

SKU 186459  
MSMA1000R **79<sup>99</sup>**

- 32 Oz. Capacity
- Not for Use with Water-Based Products
- Pressurize Up to 200 psi



### Repair Kit

SKU 186465  
MSMK10 **26<sup>99</sup>**

- Used for MSMA1000R
- Includes All Parts That Can Be Replaced
- All Chemical Resistant Seals



### Filler Cap Assembly

SKU 186466  
MSMP156 **26<sup>99</sup>**

- For Model "A" Sprayers
- Hand Removable

## Hones and Stones

### Rotor Flex-Hone®

- Lowers Harmonic Vibrations
- Ideal for New and Resurfaced Rotors and Flywheels

**64<sup>99</sup>** each

<b>Fine</b>	<b>Medium</b>	<b>Coarse</b>
SKU 341310	SKU 341298	SKU 341314
BRMRMFH240Z25	BRMRMFH120Z25	BRMRMFH60Z25



### Adjustable Disc Brake or Small Engine Hone

SKU 531707  
25030 **15<sup>99</sup>**

- Includes 3 Medium (220) Grit 3/4" Stones



## Brake Fluid Testers

### Brake Strip + 100 Ct. Coolant Strip Double Ended with Customer Cards

SKU 1089037  
PH03006-PLUS **89<sup>99</sup>**

- Double Ended Test Strips for Brake Fluid and Coolant
- Use on DOT 3 or 4 Brake Fluid
- Compatible with All Coolant Colors
- Includes: 100 Double Ended Strips and 100 Rating Scale Cards



### Double Ended Brake Fluid + Coolant Test Strips, 100 Ct.

SKU 666577  
PH03001-PLUS **84<sup>99</sup>**

### BrakeStrip Brake Fluid Copper Test Kit

SKU 289905  
PH03006 **79<sup>99</sup>**

- Everything Needed to Test Brake Fluid
- Know within 60 Seconds if it's Time for a Change
- Includes: 1 Tube of 100 Test Strips and 100 Color Pop Rating Cards



### Brake Fluid Tester - DOT 3, DOT 4, DOT 5.1

SKU 850067  
25269 **27<sup>99</sup>**

**Built-In LED Light to Ensure Tips are in Proper Contact with Fluid**

- Easily, Quickly and Precisely Checks the Water Content of 8 Types of Polyglycol-Based Brake Fluids (DOT 3, DOT 4, DOT 5.1, ACDelco DOT 3, Pennzoil, Prestone, Motorcraft and Toyota DOT 3)

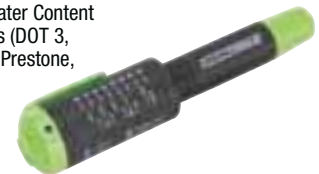

### Electronic Brake Fluid Tester

SKU 191687  
25267 **19<sup>99</sup>**

- Checks Moisture Content in Any Brake Fluid
- Multi-Colored LED Panel for Easy Recognition
- Automatic Shut-Off
- Calibrated for DOT 4 Fluid
- 1 AAA Battery Included



## Fluid Exchanger

### Premium Brake Fluid Exchange System

SKU 1407509  
MVC500-8100

**3,479<sup>99</sup>**

- Includes Brake Adapter Kit
- Pressure and Vacuum Assist
- Portable - Operates on 12 Volt DC
- Complete Brake System Exchange in 10 Minutes
- Adjustable Pressure Regulator Controls Operating Pressure
- Performs Brake Flush Using Pressure and Vacuum Simultaneously



## Brake Service Tool

### Heavy Duty Hub Drum and Rotor Puller Kit

SKU 1125878  
25106 **139<sup>99</sup>**

**Use with Impact Wrench to Remove Hubs, Drums and Brake Rotors**

- Includes 3 Hub Adapters for Use with Most Common Hub Sizes and Types
- Jaw Spread Up to 12-3/4" with 5" Reach
- Durable Forged Frame Rated to 7 Tons of Pulling Force for the Toughest Jobs
- Drum and Rotor Pulling Arms Feature with Raised Stops for Use with Ratchet Straps (Not Included)
- Easily Adjust the Arms and Set Puller in Place for Tough Pulling Jobs in Tight Spaces
- Includes: Sturdy Blow Mold Case



# TOOL STORAGE



- 24" Deep Drawers
- 100/200 Lb. Drawer Capacity
- Non-Slip PVC Drawer Liners
- UV Protected Finish
- Constructed with 16 G Steel Frame
- Lift Latch Drawer Pulls

ALSO AVAILABLE IN

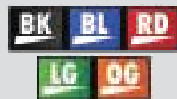

**Homak**



**72" 16 Drawer Rolling Cabinet with Stainless Steel Top – Green**

SKU 1267935  
HOM72RSPRCSG

**2,299<sup>99</sup>**

• 72"(W) x 24"(D) x 40"(H)



**54" 10 Drawer Rolling Cabinet with Stainless Steel Top – Blue**

SKU 1343816  
HOM54RSCABSBL

**1,799<sup>99</sup>**

• 54.5"(W) x 24"(D) x 40.375"(H)



**72" 3 Drawer Hutch – Black**

SKU OUTSIDE BUY/EPO  
HOM72RSPHUTBK

**1,599<sup>99</sup>**

• 71.5"(W) x 23.5"(D) x 24.375"(H)



**54" Top Hutch – Blue**

SKU 1343820  
HOM54RSPHUTBL

**1,099<sup>99</sup>**

• 54"(W) x 23.5"(D) x 24.375"(H)

**72" 16 Drawer Roller Cabinet – Black**

SKU OUTSIDE BUY/EPO  
HOM72RSPRCBBK

**2,149<sup>99</sup>**

• 72"(W) x 24"(D) x 39.25"(H)

**54" 10 Drawer Rolling Cabinet – Blue**

SKU 1442581  
HOM54RSPCABBL

**1,699<sup>99</sup>**

• 54.5"(W) x 24"(D) x 40.375"(H)



**72" 12 Drawer Top Chest – Blue**

SKU OUTSIDE BUY/EPO  
HOM72RSPCHSTOBL

**1,699<sup>99</sup>**

• 72"(W) x 23.5"(D) x 21.375"(H)



**54" 8 Drawer Top Chest – Black**

SKU OUTSIDE BUY/EPO  
HOM54RSCHSTBK

**1,199<sup>99</sup>**

• 54"(W) x 23.5"(D) x 21.375"(H)

**72" 16 Drawer Roller Cabinet – Blue**

SKU OUTSIDE BUY/EPO  
HOM72RSPRCBBL

**2,149<sup>99</sup>**

• 72"(W) x 24"(D) x 39.25"(H)

**54" 10 Drawer Rolling Cabinet – Black**

SKU OUTSIDE BUY/EPO  
HOM54RSPCABBK

**1,699<sup>99</sup>**

• 54.5"(W) x 24"(D) x 40.375"(H)



Customer Responsible For Offloading, Liftgate Service Available.

For Outside Buy/EPO, Call 901-300-4878

- Free Delivery in 48 Continental United States
- Specifications Subject to Change without Notice or Liability
- Equipment Lead Times and Shipping May Vary
- Customers Responsible for Offloading Equipment Upon Arrival
- Leasing Terms Available, Ask Your AutoZone® Commercial Sales Manager.

# TOOL STORAGE

FOR HELP with Selection, Confirm Availability and Ordering Instructions, Call 901-300-4878

TOOL STORAGE



- 24" Deep Drawers
- 100/200 Lb. Drawer Capacity
- Non-Slip PVC Drawer Liners
- UV Protected Finish
- Constructed with 16 G Steel Frame
- Lift Latch Drawer Pulls

ALSO AVAILABLE IN



**Homak**



## 44" 8 Drawer Power Service Cart – Gray

SKU 1282738  
HOMRSPRO44G **1,299<sup>99</sup>**

- Top Till Includes Full-Extension Gas Struts and a Lockable Security Compartment with an Additional Power Strip to Store and Charge Phones, Laptops and Other Devices
- Equipped with High Security Locking System to Keep Valuables Safe and Secure
- 40.5"(W) x 23.9"(D) x 40.2"(H)

Features 4 Electric Outlets and 2 USB Ports to Efficiently Charge, Store and Organize Power Tools in One Place

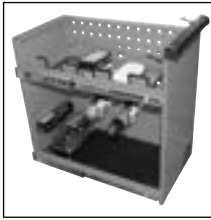

## 54" 7 Drawer Rolling Workstation - Blue

SKU OUTSIDE BUY/EPO  
HOM54RWSBL

**1,264<sup>99</sup>**

- Durable Stainless Steel Work Surface
- Four (4) 5x2" Casters with a Weight Capacity of 520 Lb. Each: 2 Swivel Locking and 2 Fixed
- 57.5"(W) x 29"(D) x 41"(H)

Features 4 Electric Outlets and 2 USB Ports to Efficiently Charge, Store and Organize Power Tools in One Place

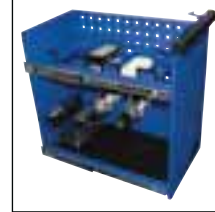

## 35" 4 Drawer Slide Top Cart – Blue

SKU 1343821  
HOM35STCBL **599<sup>99</sup>**

- 35"(W) x 20.625"(D) x 42"(H)



## 34" Professional 3 Drawer Service Cart - Black

SKU 1267944  
HOM34PSCBK **649<sup>99</sup>**

- 34.5"(W) x 16.75"(D) x 39.38"(H)



## 32" Professional 1 Drawer Service Cart - Blue

SKU 1343817  
HOM32PSCBL **399<sup>99</sup>**

- 31.5"(W) x 17.5"(D) x 35.625"(H)



## Professional Plastic Service Cart

SKU 1414408  
HOMPP06032031 **249<sup>99</sup>**

- Four 4" x 1" Swivel Casters
- Load Capacity Up to 300 Lb.
- Tray-to-Tray Distance of 16.1" for Maximum Storage



## 41" Top Hutch – Orange

SKU OUTSIDE BUY/EPO  
HOM41RSPHUTO

**849<sup>99</sup>**

- 40.75"(W) x 23.5"(D) x 24.375"(H)

## 41" 9 Drawer Rolling Cabinet – Orange

SKU OUTSIDE BUY/EPO  
HOM41RSPRCO

**1,249<sup>99</sup>**

- 41"(W) x 24"(D) x 39"(H)

## 35" 7 Drawer Flip-Top Service Cart – White

SKU 1343819  
HOM35FTSCWH

**899<sup>99</sup>**

- 31"(W) x 22.5"(D) x 38.875"(H)



## 35" Professional 4 Drawer Flip Top Service Cart - Red

SKU 1343822  
HOM35PSCR **599<sup>99</sup>**

- 35"(W) x 20.5"(D) x 39.375"(H)



Customer Responsible For Offloading, Liftgate Service Available.

For Outside Buy/EPO, Call 901-300-4878

- Free Delivery in 48 Continental United States
- Specifications Subject to Change without Notice or Liability
- Equipment Lead Times and Shipping May Vary
- Customers Responsible for Offloading Equipment Upon Arrival
- Leasing Terms Available, Ask Your AutoZone® Commercial Sales Manager.

Prices subject to change without notice. Prices do not include applicable taxes, vehicles, tires, rims, installation or optional equipment as shown. Please do not return purchases to the store. For information regarding warranty, repair, or any questions or concerns, call 901-300-4878.

AZG0225

# TOOL STORAGE

## 34" 4 Drawer Rolling Tool Cart

SKU **OUTSIDE BUY/EPO** 24636 **499<sup>99</sup>**

- Lockable Flip-Top Lid with Gas Struts
- Equipped with Tubular Locking System
- Four (4) Drawers With Replaceable Ball-Bearing Slides with a Weight Capacity of 100 Lb. per Drawer
- Foam Drawer Liners Keep Tools Stationary
- Plastic Corner Bumpers Protect from Scrapes and Dents
- Four (4) 5x2 Casters with a Weight Capacity of 330 Lb. Each: Two (2) Swivel Locking and Two (2) Swivel
- Dimensions: 34" (W) x 20.5" (L) x 46" (H)

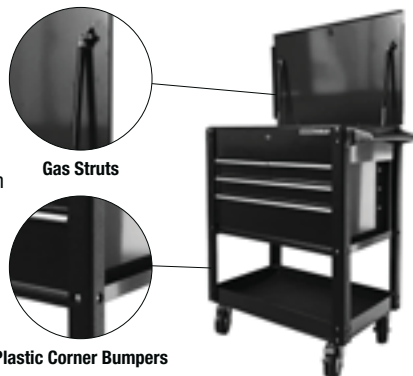

Gas Struts

Plastic Corner Bumpers



Heavy Duty Handle

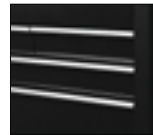

100 Lb. Capacity Slides



Tubular Lock



Heavy Duty Casters 5" x 2"

**OEM TOOLS**

**NEW**

For Outside Buy/EPO, Call 901-300-4878

## Professional Tool Carts

- Full Extension Ball Bearing Drawers for Strong, Smooth Operation (100 Lb. Capacity)
- 19 Gauge Steel Body Construction with a 16 Gauge Steel Base Reinforcement
- Complete Welded Dual-Wall Construction for Added Strength, Stability and Durability
- Quick Lock System Prevents Drawers from Opening While the Cart is Moving
- 4 Bumpers on Cart Edges Help Prevent Damage to Vehicles
- Includes EVA Liners to Keep Tools in Place
- Features 5" x 2" Heavy Duty Casters for Easy Maneuverability (Rated to 450 Lb.)
- Total Loading Capacity: 1,500 Lb.

## 28" 7 Drawer - Molded Worktop

SKU 477172 24566 **629<sup>99</sup>**

- Dimensions: 28.3"(W) x 18.9"(D) x 40.5"(H)
- Storage Space: 9,505 Cubic Inches
- Fully Sealed Plastic Work Surface is Solvent Resistant
- Integrated Pegboard Provides Additional Storage and Organization



## 36" 8 Drawer

SKU 477134 24565 **849<sup>99</sup>**

- Dimensions: 35.8"(W) x 18.9"(D) x 39.3"(H)
- Storage Space: 12,594 Cubic Inches
- Stainless Steel Work Top is Corrosion Resistant and Easy to Clean



## 57" 22 Drawer Professional Combo

SKU 662893 24738

**3,599<sup>99</sup>**

Total Loading Capacity: 2,697 Lb.

Casters Rated to 880 Lb. Each

- Overall Dimensions: 57"(W) x 24"(D) x 66.5"(H)
- Storage Space: 41,466 Cubic Inches
- Drawer Space: 13,404 Sq. Inches

**SAVE \$199**  
When you buy the combo



Part #	Description	Dimensions	Storage Space	Price
24737	57" 10 Drawer Professional Chest	57"(W) x 24"(D) x 26"(H)	18,938 Cu. In.	\$1,699.99
24736	57" 12 Drawer Professional Cabinet	57"(W) x 24"(D) x 40.5"(H)	22,528 Cu. In.	\$2,099.99
	Regular Price			\$3,799.98
24738	COMBO PRICE			\$3,599.99
	SAVINGS			\$199.99

## 57" 10 Drawer Professional Chest

SKU 666333 24737 **1,699<sup>99</sup>**

## 57" 12 Drawer Professional Cabinet

SKU 666300 24736 **2,099<sup>99</sup>**

## 36" Slide Top 3 Drawer Tool Cart - Green

SKU 666298 24731

**699<sup>99</sup>** REG. \$749.99

**SAVE \$50**

- Constructed with a 19 Gauge Steel Shell and 21 Gauge Steel Drawers
- Full Length Anodized Aluminum Drawer Pull
- Shallow Drawer Dimensions: 30"(W) x 18"(D) x 2.9"(H)
- Deep Drawer Dimensions: 30"(W) x 18"(D) x 6.1"(H)
- Overall Dimensions: 36"(W) x 21"(D) x 46"(H)



Access Your Most Used Tools with an OEMTOOLS Slide Top Tool Cart

Offer Good Through June 30, 2025

## Service Cart with Locking Lid and Drawer

SKU 512948 24961

**159<sup>99</sup>** REG. \$249.99

**SAVE \$90**

- Total Load Capacity: 350 Lb.
- Drawer Loading Capacity of 75 Lb.
- Easy to Maneuver with 4 Swivel Casters: 2 Standard and 2 Locking
- Stays Securely in Place with 2 Locking Casters
- Durable Powder Coated Finish
- Raise-and-Release Safety Drawer Latches to Prevent Drawer from Drifting Open
- Dimensions: 36"(H) x 18"(D) x 30"(L)



Offer Good Through June 30, 2025



Customer Responsible For Offloading, Liftgate Service Available.

• Free Delivery in 48 Continental United States • Specifications Subject to Change without Notice or Liability • Equipment Lead Times and Shipping May Vary • Customers Responsible for Offloading Equipment Upon Arrival • Leasing Terms Available, Ask Your AutoZone® Commercial Sales Manager.

# TOOL STORAGE

FOR HELP with Selection, Confirm Availability and Ordering Instructions, Call 901-300-4878

TOOL STORAGE

## 72" Stainless Steel 11 Drawer Cabinet and Upper Cabinet

SKU 1168659 **1,599<sup>99</sup>**  
OEM24615

### Features:

- Dimensions: 72"(W) x 18"(D) x 71.5"(H)
- Upper Cabinet is 12"(H) x 18"(D)
- Drawer Liners Included



18" Tall Pegboard

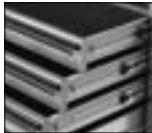

Full Extension  
100 Lb. Capacity  
Slides



PVC Coated  
MDF Top



Heavy Duty Casters  
5" x 2"



OEM TOOLS

## Tear Down Tray

VIKING

### Adjustable Mobile Work Table 200 Lb. Capacity

SKU 1485038 **164<sup>99</sup>**  
VIK52200

- Adjustable Tray
- Heavy Duty 2" Rubber Composite Swivel Casters
- Multiple Storage Slots, Trays and Insert Grooves Keeps Tools and Parts Organized and Within Reach
- 1" Drawer with Roller Bearing Slides Offer Additional Storage Capacity



Tools Not Included



## Steel Workbenches

Homak

- Black Powder Coat Finish
- Engineered for Quick Assembly
- Built-In Leg Levelers

### 59" Steel Workbench

SKU 1392321 **479<sup>99</sup>**  
HOMGW00550150

- Weight Capacity: 880 Lb.



### 59" Steel Workbench with 2 Drawers

SKU 1392318 **629<sup>99</sup>**  
HOMGW00550170

- High Security Tubular Lock System
- Ball-Bearing Drawer Slides
- Weight Capacity: 1100 Lb.



### 79" Steel Workbench with 3 Drawers and Wood Top

SKU 1392314 **599<sup>99</sup>**  
HOMGS00579030

- 1.5" Wood Work Surface with Top Mat
- Weight Capacity: 440 Lb.



### 79" Steel Workbench with 3 Drawers

SKU 1392331 **799<sup>99</sup>**  
HOMGW00550160

- High Security Tubular Lock System
- Ball-Bearing Drawer Slides
- Weight Capacity: 1100 Lb.



## Field Boxes

SHEFFIELD

### XL Field Box

- 4 Locking Options for Security
- Compression Fit Lid with Rubber Gasket for Water and Dust Resistance
- Manufactured with Impact, Abrasion and Crack Resistant Copolymer Plastics
- Food Safe and Resistant to Most Acids and Solvents
- External Dimensions: 14" (L) x 9" (W) x 9-1/4" (H)
- Internal Dimensions: 12-5/8" (L) x 6-5/8" (W) x 8" (H)



### 2 Pack Nested Field Box Set

- Includes: XL Field Box and Standard Field Box
- Standard Size Box:  
External Dimensions: 11-1/2" (L) x 5" (W) x 7-1/4" (H)  
Internal Dimensions: 9-3/8" (L) x 4" (W) x 6" (H)

**NEW**

### Olive Green

SKU 989242 **36<sup>99</sup>**  
12713

### Black

SKU OSB/EPO **36<sup>99</sup>**  
12706

### Frost

SKU OSB/EPO **36<sup>99</sup>**  
12722

### Gray

SKU OSB/EPO **36<sup>99</sup>**  
12755



Secure Stacking  
for Reliable  
Organization

Empty Boxes  
Nest Securely  
for Storage

For Outside Buy/EPO, Call 901-300-4878

### XL Field Box with Lift Out Storage Tray

- Lift-Out Tray with 8 Compartments

### Olive Green

SKU 989216 **34<sup>99</sup>**  
12712

### Black

SKU 1392328 **34<sup>99</sup>**  
12701

### White

SKU 1392312 **34<sup>99</sup>**  
12721



### XL Field Box

### Olive Green

SKU 989218 **27<sup>99</sup>**  
12710

### Black

SKU 1392313 **27<sup>99</sup>**  
12700



Prices subject to change without notice. Prices do not include applicable taxes, vehicles, tires, rims, installation or optional equipment as shown. Please do not return purchases to the store. For information regarding warranty, repair, or any questions or concerns, call 901-300-4878.

AZG0225

117

# TOOL ORGANIZATION

## 2 Post Socket Trays

### 6 Piece Socket Tray Sets

- Metric Socket Range: 4 mm to 15 mm (1/4" Drive), 6 mm to 20 mm (3/8" Drive), 10 mm to 27 mm (1/2" Drive)
- SAE Socket Range: 1/8" to 5/8" (1/4" Drive), 1/4" to 1" (3/8" Drive), 3/8" to 1-1/4" (1/2" Drive)
- Includes: 6 Trays - 1/4", 3/8" and 1/2" Drive in Both Metric and SAE



Tools Not Included

### 3 Piece Socket Trays

**OEM TOOLS**

- Includes: 3 Trays - 1/4", 3/8" and 1/2" Drive

SAE **Green** SKU 749921 22207 **24<sup>99</sup>**  
 Metric **Black** SKU 749937 22211 **24<sup>99</sup>**



Tools Not Included

Metric **Black and Green** SKU 949573 22233 **23<sup>99</sup>** REG. \$33.99 **SAVE \$10**

Metric **Black and Orange** SKU 1142583 22418 **23<sup>99</sup>** REG. \$33.99 **SAVE \$10**

Metric **Gray and Red** SKU 477209 22413 **23<sup>99</sup>** REG. \$33.99 **SAVE \$10**

Offers Good Through June 30, 2025

## Magnetic Socket Tray Sets

### 3 Piece Magnetic Socket Tray Set Metric or SAE

- Includes: 3 Trays - 1/4", 3/8" and 1/2" Drive in Metric or SAE



Blue (Metric) Metric SKU 1149155 22486 **59<sup>99</sup>**

Black (Metric) Metric SKU 1149156 22487 **59<sup>99</sup>**

Red (SAE) SAE SKU 1149183 22484 **59<sup>99</sup>**

Green (SAE) SAE SKU 1149165 22485 **59<sup>99</sup>**



**OEM TOOLS**

### 6 Piece Magnetic Socket Tray Set - Metric and SAE

- Includes: 6 Trays - 1/4", 3/8" and 1/2" Drive in Both Metric and SAE



Black and Green Metric SAE SKU 1331490 22488 **89<sup>99</sup>**



Black and Red Metric SAE SKU 1485048 22460 **89<sup>99</sup>**



Blue and Green Metric SAE SKU 1392463 22461 **89<sup>99</sup>**

Blue and Red Metric SAE SKU 1331485 22489 **89<sup>99</sup>**

- SAE • 1/4" Tray Holds 2 Sets of Sockets 1/8" to 5/8"  
 • 3/8" Tray Holds 2 Sets of Sockets 3/8" to 7/8"  
 • 1/2" Tray Holds 1 Set of Sockets 3/8" to 1-1/4"

- METRIC • 1/4" Tray Holds 2 Sets of Sockets 4 mm to 14 mm  
 • 3/8" Tray Holds 2 Sets of Sockets 6 mm to 20 mm  
 • 1/2" Tray Holds 1 Set of Sockets 10 mm to 27 mm

Tools Not Included

## Pro Socket Organizers

### Magnetic Socket Tray

SKU 082922 22389 **34<sup>99</sup>**

- Store Up to 36 Total Sockets - 1/4", 3/8" and 1/2" Drive
- Removable Back Panel Allows Magnets to Adhere to Any Magnetic Surface

**OEM TOOLS**

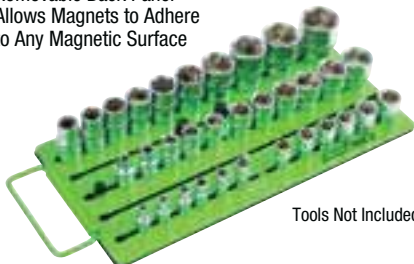

Tools Not Included

## Magnetic Socket Organizers

**OEM TOOLS**

### Portable Magnetic Socket Organizers

- Holds Up to 28 Sockets
- Powerful Magnets Hold Sockets Securely and Attach Organizer to Any Magnetic Surface
- Low-Profile Design Fits Most Toolbox Drawers



3/8" Drive SKU 1442590 23117 **29<sup>99</sup>**

1/2" Drive SKU 1414403 23118 **29<sup>99</sup>**



Tools Not Included

## Tool Holder

**OEM TOOLS**

### Magnetic Tool Holder

SKU 749848 22212 **31<sup>99</sup>**

- 18" Rail with 16 Sliding Clips
- Multipurpose Clips Hold a Variety of Tools
- Great for Screwdrivers, Ratchets, Wrenches, Pliers and Other Small Tools
- Powerful Magnet for Secure Hold
- Foam Shield to Protect Paint Finishes

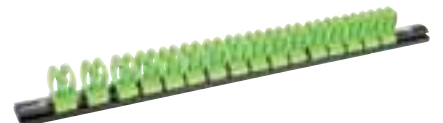

# TOOL ORGANIZATION

TO ORDER, contact your Commercial Sales Manager or go to [AutoZonePro.com](http://AutoZonePro.com)

TOOL ORGANIZATION

## Flexi-Trays

**3 Piece Set**  
SKU 943130  
22217

**59<sup>99</sup>**

- Trays Included:  
10-1/2" x 5-1/4"  
10-1/2" x 8-1/2"  
21" x 11-1/2"
- Withstands Motor Oil and Non-Corrosive Fluids
- Anti-Static, Silicone Material Protects Work Surfaces from Damage and Scratching



Tools Not Included

**OEM TOOLS**



## Organizers

**16 Piece Pliers Holder**  
SKU 765589  
22215

**13<sup>99</sup>**

- 16 Extra-Wide Spaces for Pliers with Rubber Grips
- Vinyl Coating for Lasting Dependability
- Dimensions: 14.0" (L) x 5.2" (W) x 2.5" (H)

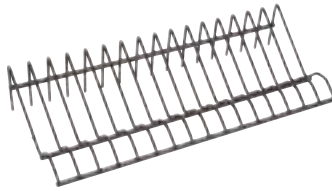

Tools Not Included

**Drawer Organizer Tray**

SKU 749932  
22213

**19<sup>99</sup>**

- Rolled Bottom Edges Allow Easy Removal of Small Parts
- Low-Profile Fits in Shallow Toolbox Drawers
- 10-Compartment Tray
- Stackable Design
- Dimensions: 16" (L) x 11" (W) x 1.5" (H)



## Magnetic Trays

**4 Piece Magnetic Foldable Tray**

SKU 1207890  
26052

**24<sup>99</sup>**

- Collapsible Tray Expands from 3/4" to 2" Deep
- Holds Up to 2 Lb.
- Multiple Color Set Keeps You Organized
- Dimensions: 4-1/2" x 4-1/2"



Tools Not Included

**OEM TOOLS**

## Magnetic Bit Holders

**4 Piece Magnetic Hex Bit Trays**

SKU 1284964  
24142

**39<sup>99</sup>**

- Each Tray Holds 36 Hex Bits
- Coated Magnetic Trays Adhere to Most Metal Surfaces



**Magnetic Trays**

- Trays Stick to Most Metal Surfaces
- Ideal for Holding Small Parts and Tools
- Heavy Duty Stainless Steel



**5" x 9"**

SKU 965834  
25117C

**14<sup>99</sup>**

- 2 Powerful Magnets with Protective Rubber Coating to Resist Scratching



**10" x 11"**

SKU 965835  
25119

**24<sup>99</sup>**

- 4 Powerful Magnets with Protective Rubber Coating to Resist Scratching



Tools Not Included

## Paper Towel Holder

**Magnetic Paper Towel Holder**

SKU 280376  
24952

**17<sup>99</sup>**

- Adjusts to Fit Different Size Rolls
- 3 Rubber-Faced Magnets Won't Scratch Metal Surfaces



Towel Roll Not Included

**OEM TOOLS**

## Wrench Organizers

**4 Piece Magnetic Wrench Rails**

- Holds 40 Wrenches
- Includes: 4 Rails
- Rail Dimensions: 16.6" (L) x 1.9" (H)

**Green**  
SKU 749850  
22217

**21<sup>99</sup>**

**Black**  
SKU 765514  
22219

**21<sup>99</sup>**



Tools Not Included



**2 Piece Wrench Organizing Rails - Black**

SKU 213161  
22218

**16<sup>99</sup>**

- Holds 35 Wrenches
- Slotted Design Will Fit a Variety of Wrench Types and Sizes
- Rail Dimensions: 23.4" (L) x 1.0" (H)



Adhesive Backs for Quick Attachment

**Magnetic Wrench Holder and Organizer**

- Holds 10 SAE or Metric Wrenches
- Magnetic Base Attaches to Your Tool Box, Tool Chest, Cart or Metallic Peg Board
- Dimensions: 9-1/4" (L) x 1-1/4" (W) x 2" (D)

**Green**  
SKU 1331491  
22512

**13<sup>99</sup>**



**Magnetic Wrench Organizer**

SKU 662782  
22177

**16<sup>99</sup>**

- Organize Up to 12 Wrenches
- Strong Magnets Will Hold Organizer Upright at Full Capacity
- Non-Marring Foam Backing
- Durable Coated Steel Construction



Tools Not Included



**Pro Magnetic Wrench Organizer (Black)**

SKU 213098  
22176

**29<sup>99</sup>**

- Organize Up to 12 Wrenches
- Strong Magnets Will Hold Organizer Upright at Full Capacity
- Non-Marring Foam Backing
- Durable Coated Steel Construction



**Black**  
SKU 1331501  
22513

**13<sup>99</sup>**



Tools Not Included

Prices subject to change without notice. Prices do not include applicable taxes, vehicles, tires, rims, installation or optional equipment as shown. Please do not return purchases to the store. For information regarding warranty, repair, or any questions or concerns, call 901-300-4878.

# HEAVY DUTY

## Scan Tools



### TEXA Diagnostic Kits

- World Class US-Based Support, with the Most Complete Vehicle Coverage
- Lifetime Repair or Replacement Equipment Warranty with Current Software Subscription
- Continual Updates on All Makes and Models with Current Software Subscription
- Fast, Powerful Hardware for Maximum Shop Efficiency
- Wiring Diagrams, Repair Procedures, Dashboards, Advanced Resets, Activations and More

#### Axone Light Truck Diagnostic Kit

SKU OUTSIDE BUY/EPO **5,999<sup>99</sup>**  
TEXAXLTHDTRK

- Advanced Diagnostics and OE-Level Coverage for Heavy-Duty Truck, Trailer, and Light Commercial Vehicles
- Includes: AXONE NEMO LIGHT, Suitable for a Large Range Of Environments and the TXT Multihub



#### Axone Plus Truck Diagnostic Kit

SKU OUTSIDE BUY/EPO **7,499<sup>99</sup>**  
TEXAXPLHDTRK

- Advanced Diagnostics and OE-Level Coverage for Heavy-Duty Truck, Trailer, and Light Commercial Vehicles
- Includes: AXONE NEMO PLUS, Suitable for a Large Range Of Environments and the TXT Multihub



#### Axone Plus Master Fleet Package for Truck/OHW/Car

SKU OUTSIDE BUY/EPO **11,999<sup>99</sup>**  
TEXAXPLMFP

- Provides Advanced Diagnostics and OE-Level Coverage for Diverse Fleets Including Car, Truck, Agriculture and Construction Equipment
- Includes: AXONE NEMO PLUS, Suitable for a Large Range Of Environments, the TXT Multihub and the Off-Highway Essential Cable Case



For Outside Buy/EPO, Call 901-300-4878

## Smoke Leak Detector



### Dual Evap Smoke Machine\*

SKU OUTSIDE BUY/EPO **1,649<sup>99</sup>**  
MSC43065

- For Evap, Turbo/Intake and Heavy Duty Truck Testing\*
- For Evap and High Pressure Diagnostic Testing
- Multiple Options for Smoke Injection Include Built-In Internal Compressor, Shop Air and Inert Gases
- Accessories Include: Smoke Hose, Block Off Caps, Exhaust Cone, Schrader Valve Remover/Installer, Evap Service Port Adapter Hose, Smoke Illuminating Flashlight, Smoke Producing Fluid and Bladder



\* Heavy Duty Truck Testing Requires MSC43062 Adapter Kit, Not Included (Sold Separately)

## Cooling System



### Heavy Duty Cooling Kit

SKU 954231 **479<sup>99</sup>**  
MSC43306

- Includes Heavy Duty Vehicle Adapters, Pressure Test Regulator, Vacuum Refill Attachment with Tubing in a Plastic Case
- For Use with Freightliner, International, Kenworth, Peterbilt, Mack, Volvo, GMC and Sterling Cooling Systems
- Uses Shop Air to Pressure Check and Vacuum Refill
- 4 Quick-Disconnect Vacuum Attachments Provide Quick Refilling of the Cooling System and Eradicates Airlocks



## Recovery Machine



### Fully-Automatic Heavy Duty R134a Refrigerant Management System

SKU 1407805 **7,249<sup>99</sup>**  
CPSMXHD

- For Commercial and Heavy Duty Applications
- 6 CFM Dual-Stage Vacuum Pump
- Large 12.67 CC Twin-Piston Oilless Compressor
- Comes Standard with a 50 Lb. Tank; Upgradeable to 90 Lb.
- Wi-Fi and Bluetooth Enabled





## Specialty Tools

### NAVISTAR® MAXXFORCE® Fuel Line Disconnect Tool Set - 4 Piece

SKU 004112 **34<sup>99</sup>**  
25031

- For Series 11 and 13 Engines
- Sized to Depress Fuel Release Tabs for Efficient Fuel Line Removal
- 1 Straight and (1) 90° Tool for 11.8 mm Fuel Lines;
- 1 Straight and (1) 90° Tool for 16 mm Fuel Lines



### Heavy Duty U-Joint Puller

SKU 041474 **124<sup>99</sup>**  
24538

- Easily Removes Seized U-Joint Cups on Most Class 7 and 8 Trucks
- Safely Disassemble Drivelines without Hammering or Heating Components
- Does Not Damage the Driveshaft, Yokes, Joints or Bearing Cups
- Bearing Cup Outside Diameter: 1.5" to 2.2"



### Automatic Slack Adjuster Release Tool and Wrench

SKU 1207889 **24<sup>99</sup>**  
25252

- 5/16" Double Square Ratchet Has an Angled Head to Give Extra Clearance for Hands
- Side-Mounted Forward/Reverse Lever for Easy Operation
- Speeds Up Installation on Meritor® Heavy Duty Truck Brake Slack Adjusters to Simplify Brake Service



### Brake Anchor Pin Press **OEM TOOLS®**

SKU 1361998 **124<sup>99</sup>**  
27090

- For Removal of Brake Anchor Pins and Bushings on 16-1/2" S-Cam Trailer and Tractor Q Brake Systems
- No Need to Remove the Hub or Dust Shield
- Rigid C-Frame with 10 Ton Capacity
- Manufactured from High Grade Steel for Strength and Durability
- Manual, No Hydraulics Required



## Heavy Duty Wheel and Tire Service

### Heavy Duty Truck Wheel Changer

SKU OUTSIDE BUY/EPO **25,849<sup>99</sup>**  
ROTR501PLUS

- Dismount and Mount a Truck Tire in 30 Seconds
- Super Fast Truck Tire Changer
- Adjustable Arm Position
- Max. Tire Diameter: 52"
- Quick Loading



**INCLUDES: Set Up and Training**

WARRANTY: 3 Years Parts and Labor

### Heavy Duty Wheel Balancer

SKU OUTSIDE BUY/EPO **10,899<sup>99</sup>**  
ROTR540

- Designed to Fit Commercial Truck, Light Truck and Passenger Vehicles
- Balance Compact Cars to HD Trucks
- Auto Stop on Top for Weight Position
- Auto Entry of Distance and Diameter
- Integrated Wheel Lift Up to 441 Lb.
- Max. Rim Diameter: 30"
- Max. Tire Diameter: 51"



**INCLUDES: Set Up and Training**

WARRANTY: 3 Years Parts and Labor

### Coats® CHD-6330 Heavy Duty Tire Changer

SKU OUTSIDE BUY/EPO **20,499<sup>99</sup>**  
AMM8006330

- Motor: 2 HP
- Max. Tire Diameter: 63"
- Rim Diameter: 13" to 27"
- 4-Jaw Chuck Allows for Fast and Easy Clamping of Virtually All Rim Styles
- Features Portable Control Station
- Solid, Single Piece Frame for Added Capacity and Dependability



**INCLUDES: Manufacturer's Set Up**

WARRANTY: 1 Year Parts and 6 Months Labor

### Coats® 6450-3D Heavy Duty Balancer

SKU OUTSIDE BUY/EPO **18,449<sup>99</sup>**  
AMM64503DKT1P

- **Kit Includes Wheel Lift Plus Lug and Hub Centered Budd Style Adapters**
- Dual Calibration Software Stores and Runs Two Independent Sets of Calibrations
- Powerful 1.5 HP Direct Drive Motor Shaves 20 Seconds Off of a Typical 22.5" Spin
- Designed for High Volume Balancing, the Perfect Machine for Delivery Vehicles and Tractor Trailers
- Max. Tire Diameter: 52"
- Max. Tire Weight: 500 Lb.



**INCLUDES: Manufacturer's Set Up**

WARRANTY: 1 Year Parts and 6 Months Labor



Customer Responsible For Offloading, Liftgate Service Available.

For Outside Buy/EPO, Call 901-300-4878

## Low Profile Oil Drain

### 17 Gallon Low Profile Truck Drain

SKU 526486 **469<sup>99</sup>**  
LIN3665

- 6' Hose Extends from the Bottom of the Reservoir and Can Be Connected to a Pump to Evacuate Fluid from the Drain



**LINCOLN**

## Truck Tire Tool

### Tubeless Truck Tire Iron

SKU 394384 **109<sup>99</sup>**  
KTL34645

- Tip Ends Insert Easily and Will Not Cut or Rip Bead or Sidewall
- Length: 37"
- Stock Diameter: 3/4"

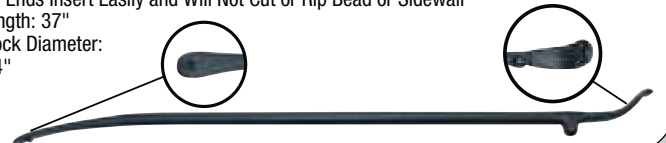

**Ken-Tool**

• Free Delivery in 48 Continental United States • Specifications Subject to Change without Notice or Liability • Equipment Lead Times and Shipping May Vary • Customers Responsible for Offloading Equipment Upon Arrival • Leasing Terms Available. Ask Your AutoZone® Commercial Sales Manager.

Prices subject to change without notice. Prices do not include applicable taxes, vehicles, tires, rims, installation or optional equipment as shown. Please do not return purchases to the store. For information regarding warranty, repair, or any questions or concerns, call 901-300-4878.

# HEAVY DUTY

## Heavy Duty Lifts

### 56,000 Lb. Mobile Lift System/Set of 4

SKU OUTSIDE BUY/EPO  
CHLCLHM-140-4

**49,449<sup>99</sup>**

- 110 Volt Charging System
- Completely Wireless System
- Adjustable Wheel Carriage Adapts from 5" to 24.5"
- Integrated Touch-Screen Control Console at Each Column Allows Operation from Any Unit
- 14,000 Lb. Capacity per Column

**Includes: Batteries, Fluids and Factory Training**

**WARRANTY: 1 Year Parts and Labor**



**CL Challenger Lifts**

### 27,000 Lb. Heavy Duty Truck Lift

SKU OUTSIDE BUY/EPO  
BENHDS27

**26,599<sup>99</sup>**

- Runways Include Rail-Kit for Optional Accessories
- Runways Adjust for Different Tread Widths
- Electric/Hydraulic Power System
- Fully Enclosed Lifting Cables, Safety Locks and Sheaves
- Pneumatic Push-Button Safety Release
- Length: 24-3/4'

**WARRANTY: 1 Year Parts and Labor**



**BendPak**



**Customer Responsible For Offloading.**

**For Outside Buy/EPO, Call 901-300-4878**

## Lifting Equipment

### 6,000 Lb. Heavy Duty Engine Crane

SKU 1267948  
AFF3584

**1,399<sup>99</sup>**

- 4 Different Boom Settings: 3, 2, 1.5 and 1 Ton
- Rear of Crane: 61.5" Tall and 33" Wide
- Distance Between Front of Legs: Retracted 23", Extended 28.5"



### 35 Ton Air Hydraulic Axle Jack

SKU 954200  
AFF536

**1,749<sup>99</sup>**

- Unique Motor Design Advances Ram to Load Faster
- Air Assisted Lowering and Dual Return Springs Provide Controlled and Easy Descent
- Safety Overload System Prevents Jack from Being Used Beyond its Rated Capacity
- Corrosion Resistant Aluminum and Nylon Composite Air Motor



**AFF**

## Locknut Sockets

**OEM TOOLS**

### 7 Piece Wheel Bearing Locknut Set

SKU 1207886  
37385

**114<sup>99</sup>**

- Includes: 55 mm 6PT, 2-3/8" 6R, 2-3/8" 6PT, 2-1/2" 6R, 2-1/2" 6PT, 2-9/16" 6R and 2-3/4" 6R
- Comes with Standard Hex (6PT) and Rounded (6R) Hex Sockets to Fit Many Applications
- For Use with 1/2" Square Drive Ratchet, Breaker Bar or Torque Wrench



### 5 Piece Budd Wheel Socket Set

SKU 1207878  
37384

**119<sup>99</sup>** REG. \$139.99

- 35 mm, 38 mm, 41 mm and 1-1/2" Sockets Feature a Dual Socket Design with a Hex to Remove the Lug Nut and an Internal Square Drive to Remove the Inside Wheel
- 38 mm, 41 mm and 1-1/2" Sockets Each Have a 13/16" Internal Square
- 35 mm Socket Has a 11/16" Internal Square
- For Use with 1" Drive Ratchet, Breaker Bar, Torque Wrench and Impact Wrench



**SAVE \$20**

**Offer Good While Supplies Last Through June 30, 2025**

### Truck Axle Wheel Bearing Sockets

- 3/4" Square Drive
- Constructed with High-Grade Steel for Strength



#### 4", 6 Pt.

SKU 466541  
25482

**34<sup>99</sup>**

#### 2-9/16", 8 Pt.

SKU 466534  
25473

**29<sup>99</sup>**

#### 4-1/8", 6 Pt.

SKU 265085  
25483

**39<sup>99</sup>**

#### 4-3/8", 8 Pt.

SKU 466543  
25485

**44<sup>99</sup>**

## Heavy Duty Stands

### 22 Ton Heavy Duty Axle Stands (Pair)

SKU 757098  
24854

**179<sup>99</sup>**

- Min. Height: 12-1/4"
- Max. Height: 19-3/4"
- Adjustable Pin Design
- Features Handle for Transport and Positioning
- Large V-Shaped Saddles Center Lift Points for Secure Placement



**OEM TOOLS**

## Heavy Duty Truck Oil Filter Wrenches

**OEM TOOLS**

### Small

SKU 344322  
25231

**19<sup>99</sup>**

- Range: 4-1/8" to 4-5/8" (104 to 118 mm)

### Medium

SKU 344323  
25232

**19<sup>99</sup>**

- Range: 4-5/8" to 5-1/4" (118 to 134 mm)

### Large

SKU 344324  
25233

**21<sup>99</sup>**

- Range: 5-1/4" to 5-3/4" (134 to 142 mm)



- **Free Delivery** in 48 Continental United States
- **Specifications Subject to Change without Notice or Liability**
- **Equipment Lead Times and Shipping May Vary**
- **Customers Responsible for Offloading Equipment Upon Arrival**
- **Leasing Terms Available. Ask Your AutoZone® Commercial Sales Manager.**

## Shop Presses

### 20 Ton Super Duty Air/Manual Shop Press

SKU OUTSIDE BUY/EPO 29000

**1,099<sup>99</sup>**

- Fully Welded Construction And Powder-Coated Steel Frame for Unmatched Durability
- Movable Cylinder and 10 Height Adjustments with 4.3" Increments for Operator Versatility
- Glycerin-Filled Pressure Gauge Ensures Precise Pressure Readings Every Time
- Air/Hydraulic Pump Supports Both Manual and Pneumatic Operation (110-120 psi)
- Includes Anti-Slip Steel Blocks and Meets ASME PASE-2019 Standards



**NEW**

For Outside Buy/EPO, Call 901-300-4878

### 30 Ton Super Duty Air/Manual Shop Press

SKU 1525570 29001

**1,399<sup>99</sup>**

- Fully Welded Construction for Exceptional Strength and Durability
- Movable Cylinder for Added Flexibility In Working Position
- Glycerin Filled Pressure Gauge for Accurate Pressure Readings
- Polycarbonate Protective Guard Shield for Maximum Safety Against Shrapnel and Debris
- Air/Hydraulic Pump Supports Both Manual and Pneumatic Operation (110 to 120 psi)
- Includes Anti-Slip Steel Blocks and Meets ASME PASE-2019 Standards

**Polycarbonate Protective Guard Shield for Maximum Safety Against Shrapnel and Debris**

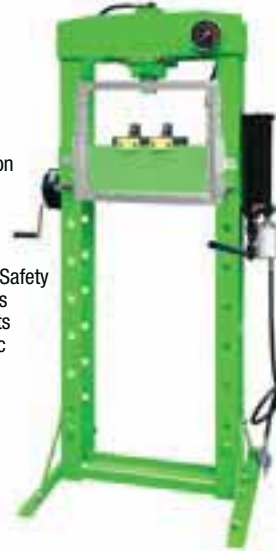

**NEW**

### 20 Ton Air Hydraulic Shop Press

SKU 662928 25087

**799<sup>99</sup>**

- Removable Press Cap with 25 mm Hole to Accept OEMTOOLS Press Pin Set (#24813)
- Air/Hydraulic Pump Provides Added Versatility
- Double Speed Pump Greatly Reduces Set-Up and Press Time
- Movable Press Head for Flexibility of Working Positions
- Liquid Filled Pressure Gauge for Accurate Pressure Readings
- Durable Powder Coated Steel Frame
- Includes Press Blocks



Liquid Filled Dual Scale Gauge



Removable Press Cap with 25 mm Hole

**OEMTOOLS®**



### 10 Ton Hydraulic Benchtop Shop Press

SKU 666327 25088

**499<sup>99</sup>**

- Removable Press Cap with 25 mm Hole to Accept OEMTOOLS Press Pin Set (#24813)
- Double Speed Pump Greatly Reduces Set-Up and Press Time
- Movable Press Head for Added Flexibility in Working Position
- Liquid Filled Pressure Gauge

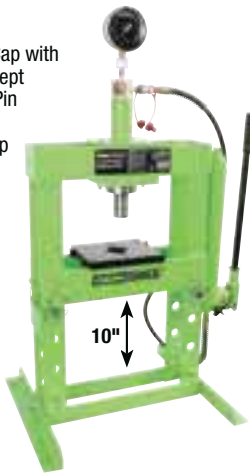

10"

### 20 Ton Shop Press

SKU 300134 24810

**699<sup>99</sup>**

- Stronger Compared to Similar Lighter Weight Shop Presses on the Market
- Includes Press Plates
- Remove and Install Bearings, Gears, U-Joints, Bushings, Ball Joints and Pulleys
- Multi-Position Bed for Work Height Adjustment
- Max. Height: 31.5"
- Max. Width: 21.75"



1-3/4" Diameter Ram



Manually Adjustable Table

**Super Heavy Duty**



**H-Frame Press Weighs Over 250 Lb.**

### 8 Piece Press Accessory Kit

SKU 1525566 29002

**189<sup>99</sup>**

- Versatile Press Accessory Kit Works on Many Different Press Sizes
- Includes: 2 Press Plates, 5 Punches, a Quick Change Adapter Chuck and a Bearing Shield
- 5 Punches Fit a Wide Range of Applications with Sizes 1/2", 3/4", 1", 1-1/2" and 2"
- Capacity of Up to 50 Tons with the Largest Punch



**NEW**

### 30 Ton X Style Press Plates

SKU OUTSIDE BUY/EPO 24808

**134<sup>99</sup>**

- For Use on All Presses Up to 30-Ton Capacity
- "X" Type Design for Use in Many Different Pressing Operations
- 1.2" Steel Thickness to Comply with ASME PASE Requirements



**NEW**

For Outside Buy/EPO, Call 901-300-4878

## Bearing Separators

### 5 Ton Bar-Type Puller/Bearing Separator Set

SKU 347218 27236

**99<sup>99</sup>**

- Separator Tools are Used with Bar Puller and Legs for a Wide Variety of Pulling Jobs
- Set Includes: 2" and 3" Bearing Splitters, 4 Sets of Hex Push-Puller Legs and a Bar-Type Puller Head with a 9/16" Forcing Screw

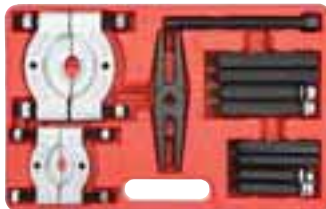

### Bearing Splitter 1/4" to 15/16"

SKU 514005 27231

**29<sup>99</sup>**

- Maximum Spread: 15/16"
- Minimum Spread: 1/4"
- Thread of Tapped Holes in Adapter: 5/16" to 18"
- Distance Between Adjusting Screws: 1-11/16"

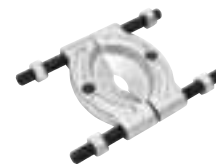

**OEMTOOLS®**

### Bearing Splitter 1/2" to 4-5/8"

SKU 514006 27232

**59<sup>99</sup>**

### Bearing Splitter 1/8" to 2"

SKU 516522 27084

**29<sup>99</sup>**

## Press Support

### Universal Press Support

SKU 804487 24809

**199<sup>99</sup>**

- Will Make Your Shop Press Safe and Easy to Use
- Supports in 3 Points to Ensure Safe Support without Any Wobbling
- Numerous Holes on Main Block and Swivel Element for Easy Set-Up
- Swivel Element and Removable/Height Adjustable Anvil Bolts Allow Adjustment to Individual Requirements
- Dimensions: 7-3/4" (W) x 9-3/4" (L) x 1-1/2" (H)

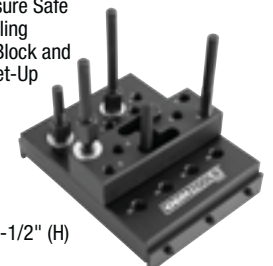

**OEMTOOLS®**

# SHOP EQUIPMENT

## Aqueous Parts Washers

### Steel Parts Washers

- Works with Safe Water-Based Cleaning Solutions Only (Not for Use with Solvents)

- 325 GPH Pump
- Includes a Drain Shelf

- Powder-Coated 20 Gauge Steel for Durability and Rust Resistance

#### 3.5 Gallon Bench Top

SKU 300128  
24800 **99<sup>99</sup>**

- Dimensions: 18" (L) x 13-1/2" (W) x 9" (H)



#### 20 Gallon Mobile

SKU 750449  
24805 **329<sup>99</sup>**

- 4" Casters for Maneuverability
- Drain Tray with 2.9 Gallon Collection Reservoir
- Dimensions: 38" (L) x 21.5" (W) x 37" (H)



#### 20 Gallon

SKU 300117  
24801 **299<sup>99</sup>**

- Small Parts Tray
- Dimensions: 31" (L) x 21" (W) x 34.5" (H)



#### 40 Gallon

SKU 300118  
24803 **479<sup>99</sup>**

- Small Parts Tray
- Dimensions: 44.75" (L) x 20.5" (W) x 35" (H)



**OEM TOOLS**

### Pneumatic Heated Parts Washer Cabinet

SKU 1330681  
24677 **679<sup>99</sup>**

- Uses Compressed Air to Spray Heated Cleaner for Maximum Cleaning Effectiveness
- Fully Enclosed Chamber Keeps Cleaning Solution and Debris Contained
- Thermostat Controlled Heating Element Heats Cleaning Solution Up to 140°F (60°C)
- Fluorescent Lighting Inside Cabinet Illuminates Work Area
- Built-In Vent Fan Improves Visibility Inside Chamber While Cleaning
- Built-In Air Pressure Regulator and Gauge
- Adjustable Leveling Pads for Added Stability on Uneven Floors
- Holds Up to 3.5 Gallons of Cleaning Solution



### 4 Gallon Mobile Parts Washer

SKU 546660  
24804 **179<sup>99</sup>**

- Lid Has Positive Seal and Latches for Mobility
- 4 GPM Pump
- Dimensions: 26" (L) x 18" (W) x 9.5" (H)



### Portable Bucket-Top Parts Washer

SKU 003759  
24816 **59<sup>99</sup>**

- Fits Most Standard 5 Gallon Buckets
- Includes: Submersible Pump, 40" Hose and Flow-Through Brush
- Pumping Rate: 1 GPM



Does Not Include 5 Gallon Bucket



## Biological Parts Washers

### Ocean Sunset 3.0 Pack

SKU OUTSIDE BUY/EPO  
SRIPAF0000623

**3,349<sup>99</sup>**

- 26 Gal. Tank Capacity
- Environmentally Friendly and Solvent Free
- Soak Sink for Cleaning of Heavy Soiled Parts
- Multi-Stage Heater
- Sealed Lid
- Includes: (5) 5 Gallon Containers of Bluesolution and 4 Tablets



### Gravity X2 Mobile Pack

SKU OUTSIDE BUY/EPO  
SRIPAF0000717

**2,199<sup>99</sup>**

- 10 Gal. Tank Capacity
- Heating Speed of 15 Minutes
- Regulated to 100°F
- Easy to Move Around
- Environmentally Friendly and Solvent Free
- Simple Controls
- Easy Maintenance
- Air or Electric
- Includes: (2) 5 Gallon Containers of Bluesolution and 4 Tablets



For Outside Buy/EPO, Call 901-300-4878

### BlueTablets SRBT

SKU 1485037  
SRIOFOMBT1100

**89<sup>99</sup>**

- Simple Small Tablets
- Convenient
- Qty: 4 Tablets



### BlueLiquid SRBLPE+ Aqueous Solution

SKU 1485035  
SRIPFOL2P-100

**159<sup>99</sup>**

- Designed for Industrial Cleaning
- Concentrated Cleaning Solution for Biological Parts Cleaning
- Water Based
- ECO friendly



## Washer Accessories

### Straight Handle Flow Thru Parts Washer Brush

SKU 1368637  
BRMPWA **39<sup>99</sup>**

- Made with Synthetic Filaments to Resist Solvent Cleaners
- Works with Most Popular Recirculating Parts Washers
- For Use in Either Petroleum-Based or Water Based Solutions



### Parts Washer Brush without Tube

SKU 1368624  
BRMPWANT **34<sup>99</sup>**

BRM

### Air Operated Sprayer

SKU 222507  
LIN5983 **79<sup>99</sup>**

- 1/4" NPT (F) Inlet
- Max. Operating Pressure: 150 psi
- Can Be Used with Solvents or Detergent Solutions



LINCOLN

## Abrasive Blasting

### Bench Top Abrasive Blast Cabinet

SKU 300119  
24815 **274<sup>99</sup>**

- Easily Remove Paint, Rust and Oxidation
- Fits on the End of Any Bench or Cabinet
- Overall Height: 19.3"
- Exterior Width: 19.3"
- Work Area: 3.18 Cubic Ft.
- Includes: 10 Replaceable Window Underlays

**OEM TOOLS**



### 25 Lb. Glass Bead Blasting Media

- Ideal for Many Uses
- Removes Surface Rust
- Paint and Body Applications

#### Coarse

SKU 010136  
SHA13077 **189<sup>99</sup>**

#### Medium

SKU 010139  
SHA13078 **189<sup>99</sup>**

SHARK USA

## Better for the Environment and the Bottom Line



**Toucan Pack**  
The absorbent recycling pack



### All-in-One Cleaning Concept

The **Toucan Pack** is an all-in-one mobile cart that distributes and recycles **Fibercan+** Absorbent. Clean up oils, coolant, solvents and water **while saving money** by reusing the absorbent up to eight times.

- 1 Effective**  
Instant absorption safely dries floors. Leaves no greasy film and eliminates dust.
- 2 Economical**  
Ideal for small and large clean ups. Absorbs up to 8 times more spills than traditional sawdust and granules.
- 3 Efficient**  
Cart includes tools, sifting tray, **Fibercan+** Absorbent and space for mats, gloves, etc.

### 8 Times More Savings

Traditional Absorbents **VS** Fibercan+ Absorbents

Consumption

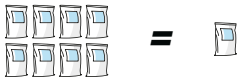

### Toucan Pack®

SKU **OUTSIDE BUY/EPO** **999<sup>99</sup>**  
SRIPPAF00015

- Includes: Mobile Cart, (1) 20 Lb. Bag of Fibercan+ Absorbent, Easy to Reach Collection Tray, Ergonomic Sifting System, Broom, Dust Pan and Tool Holder

### Fibercan+ Absorbent

SKU **1414395**  
SRI0PEAFIC001

**69<sup>99</sup>**  
• 20 Lb. Bag



Scan for video

### Spray Wash Cabinets

- Heavy Duty Steel Construction
- Removable Parts Tree
- Brass Nozzles
- Heavy Duty Rubber Casters
- Stainless Oil Skimmer
- Removable Tank Screen

Each Cabinet Includes:  
20 Lb. Aluma-Klean Soap Bucket

**VALUE: \$124.99**



### Aluma-Klean Soap Bucket

**20 Lb.**  
SKU **751966** **124<sup>99</sup>**  
RAN5155096

**50 Lb.**  
SKU **1442593**  
RAN5155100  
**289<sup>99</sup>**



### Solvent-Free Cleaning Solution

#### Heavy Duty Degreaser Concentrate (5 Gallons)

SKU **227558** **279<sup>99</sup>**  
WWSHD-5G

Designed to Effectively Replace Hazardous Solvent in Water-Based Parts Washers

- Quickly Removes Grease, Oil, Carbon and Grime While Safe for the Technician



SKU	Part #	Product	Tank Capacity	Load Capacity	Price
OUTSIDE BUY/EPO	RANRS500DS	Stainless Steel	50 Gallon	500 Lb. Load	<b>11,899.99</b>
OUTSIDE BUY/EPO	RANRS750DS	Stainless Steel Truck	53 Gallon	1,000 Lb. Load	<b>12,649.99</b>
OUTSIDE BUY/EPO	RANRS500D	Professional	50 Gallon	500 Lb. Load	<b>7,949.99</b>
OUTSIDE BUY/EPO	RANRS750D	Truck	53 Gallon	1,000 Lb. Load	<b>8,449.99</b>



Customer Responsible for Offloading, Liftgate Service Available. For Outside Buy/EPO, Call 901-300-4878

### Vises



#### 4-1/2" Light Duty Bench Vise with Swivel Base

SKU **751645** **39<sup>99</sup>**  
24216

- Clamping Strength: 100 Lb.



#### 4" Heavy Duty Bench Vise with Swivel Base

SKU **751643** **49<sup>99</sup>**  
24217

- Clamping Strength: 200 Lb.



#### 6" Heavy Duty Bench Vise with Swivel Base

SKU **751654** **119<sup>99</sup>**  
24218

- Polished Replaceable Steel Jaws
- Polished Anvil, Permanent Pipe Jaws
- Full 360° Swivel Base
- Clamping Strength: 300 Lb.



#### 6-1/2" Professional Workshop Vise

SKU **394648**  
KTL64065

- Clamping Strength: 399<sup>99</sup>
- Jaw Width: 6-1/2"
- Jaw Opening: 9" Replaceable, Reversible Jaws



# SHOP EQUIPMENT

## Pipe Bender

### BB-2 Pipe Bender with 302 Die Package

SKU OUTSIDE BUY/EPO  
BENBB2

**11,499<sup>99</sup>**

- Knee Control and Depth-of-Bend Degree Plate for Manual Bending Operations
- Includes: BB-2 Tooling Package, Quick Release Bending and Finishing Dies, High-Speed Clampless Swager and Internal Expander



### 1302 Automatic with 302 Die Package

SKU OUTSIDE BUY/EPO  
BEN1302BAS302

**12,299<sup>99</sup>**

For Outside Buy/EPO, Call 901-300-4878

## BendPak



### Large 3" Die Package – Optional

SKU OUTSIDE BUY/EPO  
BEN300-1

**1,579<sup>99</sup>**

- Optional Die Package Extends the Bending Capabilities of Your BendPak Pipe Bender

## Drill Press

OEM TOOLS

### 15" 16 Speed Floor Drill Press

SKU 082857  
24992

**SAVE  
\$50**

**449<sup>99</sup>** REG. \$499.99

- Drilling Depth: 3-5/16"
- 16 Speed Spindle: 240 to 3,200 RPM
- Dimensions: 15" x 25-1/3" x 63-1/3"
- Distance from Spindle to Table: 27"
- Distance from Spindle to Base: 47"



Chuck Size:  
5/8" JT3 Taper

Swings:  
15"

Offer Good While  
Supplies Last Through  
June 30, 2025

## Shop Vacuums

### Air Blow and Suction Gun

SKU 1168663  
26038

**SAVE  
\$10**

OEM TOOLS

**39<sup>99</sup>** REG. \$49.99

- One-Touch Button That Changes the Gun from Blow to Suction
- Standard Shop Vacuum Power for Quick and Easy Clean Up
- Lightweight Gun
- High Filtration Collection Bag
- Rugged and Durable Metal Construction and Easy-to-Use Trigger
- 1/4" PT/NPT Inlet and 90 psi



Offer Good While  
Supplies Last  
Through June 30, 2025

## Headlight Aimer

### Headlight Aiming System

SKU OUTSIDE BUY/EPO  
SYMHBA5

**2,629<sup>99</sup>**

- Certified in Maryland and Virginia
- Laser Floor Slope Measurement (Accurate, Precise and Easy to Achieve)
- Photosensor Positioning

For Outside Buy/EPO,  
Call 901-300-4878



## Key Programmer

ilco

### Smart Pro Lite Vehicle Key Programmer

SKU 1414393  
KABSMARTPROLT

**2,049<sup>99</sup>**

- Includes: OBDII Cable, Main Cable, Charger and Hard Body Case
- Wi-Fi and Bluetooth Connectivity
- 75% Vehicles in Operation Coverage
- Compatible with the ADC245 Smart Aerial Plus+ and MyKeysPro (MKP)
- No Need to Purchase Tokens, Software or Standard UTP
- Free Updates for 1 Year
- Only Works with Ilco Remotes and Keys, Not Compatible with Other Brands



## Key Machines

- Includes Three Functions: Copy by Original, Decode and Cut by Code
- Fast Key Search – Enter Make/Model/Year and the Software Guides You Through the Process
- US Based Tech Support Available

### Futura Auto Electric Key Machine

SKU 1267953  
KABFUTURAAUTO

**4,749<sup>99</sup>**

- User Friendly Software with Step-By-Step Instructions
- Multiple Language Support
- Step-By-Step Calibration
- Automatic Tip Detection for Tip Gauged Keys



### Futura Pro Electric Key Machine

SKU 1267950  
KABFUTURAPRO

**10,869<sup>99</sup>**

- Two Cutting Stations - One for Edge and One for Laser and Dimple Keys



## Popular Remote Assortment Kits

ilco

### 35 Piece Most Popular

SKU 1267947  
KAB0221-35

**1,479<sup>99</sup>**

### 100 Piece Most Popular

SKU 1267939  
KAB0221-100

**3,469<sup>99</sup>**

### 35 Piece Most Popular Late Model

SKU 1267965  
KAB0221-35LM

**1,599<sup>99</sup>**



Go to [AZTOOL1.com](http://AZTOOL1.com) for  
Remote Kit Component List and  
Application Chart



## Pressure Washers

### Electric Pressure Washer

SKU OUTSIDE BUY/EPO MTMCW3004SME1 **5,049<sup>99</sup>**

- Pump Accepts Incoming Water Up to 165°F
- PSI: 3000 GPM 3.9
- Includes Quick Connect Nozzles – 0°, 15°, 25° and 40°, 50', 50' x 3/8" High Pressure Hose, Insulated Trigger Gun and Adjustable Pressure Insulated Dual Lance and 35' Power Cord
- 8.0 HP, 230V



WARRANTY: 1 Year Electric Motor and 7 Year General Pump

### Wall Mount Electric Pressure Washer

SKU OUTSIDE BUY/EPO MTMCAW20040ME1

**3,549<sup>99</sup>**

- Pump Accepts Incoming Water Up to 165°F
- 2000 psi, 3.9 GPM
- 6.0 HP, 230V
- Includes: Quick Connect Nozzles – 0°, 15°, 25° and 40°, 50' x 3/8" Hose and 36" Adjustable Pressure Dual Lance



WARRANTY: 1 Year Electric Washers and 7 Year General Pump



## Dual Fuel Powered Generator

### 5500-Watt Dual Fuel Portable Generator

SKU OUTSIDE BUY/EPO CHM201505

**849<sup>99</sup>**

- Dual Fuel: Runs on Gasoline or Propane, Providing Up to 11 Hours of Run Time on Gasoline or 6.5 Hours on Propane
- Monitors Voltage, Frequency and Run-Time Hours



WARRANTY: 3 Years Limited

CARB Compliant

To Confirm Price, Availability and Ordering Instructions on Outside Buy/EPO Call 901-300-4878

## Hot Water Pressure Washers

### HSE 1400 psi Hot Water Pressure Washer

SKU OUTSIDE BUY/EPO MTMHSE1400M11 **3,149<sup>99</sup>**

- Diesel or Kerosene Fired Burner
- 1400 psi, 2.0 GPM
- 1.5 HP, 120V
- Includes: 50' x 3/8" Wire Braided Hose, Adjustable Pressure Insulated Dual Lance with 15° Fixed and Detergent Nozzle



WARRANTY: 1 Year Electric Motor, 3 Years Coil and 7 Years Mi-T-M Pump

### HSE 1500 psi Hot Water Pressure Washer

SKU OUTSIDE BUY/EPO MTMHSE15020MM

**3,899<sup>99</sup>**

- Diesel or Kerosene Fired Burner
- Fuel Consumption: 1.2gph
- 1500 psi, 2.0 GPM
- Temperature Rise: 150°F (66°C); Max. Outlet Temperature: 200°F (93°C)
- Includes: Quick Connect Nozzles – 0°, 15°, 25° and 40°, 50' x 3/8" Wire Braided Hose and Adjustable Pressure Insulated Dual Lance



WARRANTY: 1 Year Electric Motor, 3 Years Coil and 7 Years Mi-T-M Pump



## Floor Scrubbers

### Battery Powered 14" Floor Scrubber

SKU OUTSIDE BUY/EPO IPCCT15

**4,674<sup>99</sup>**

- Height-Adjustable Handle
- Removable Recovery Tank
- 1.5 Hour Run Time
- Includes: Lithium Battery, Charger and Brush



### Battery Powered 20" Floor Scrubber

SKU OUTSIDE BUY/EPO IPCCT50

**4,914<sup>99</sup>**

- 13 Gallon Tank Capacity
- 2.5 Hour Run Time
- For Up to 10 Bay Shop
- Includes: Self-Leveling Brush Head and Cast Aluminum Squeegee Assembly, 2 AGM Maintenance Free Batteries and Charger



### Cleaner/Degreaser 1 Quart Bottle (6 Pack)

SKU OUTSIDE BUY/EPO IPCCT80451 **99<sup>99</sup>**

- High Performance Concentrated Formula Quickly Cuts through Grease, Oil and Tough Carbon Soils

## SHOP OWNERS, WE LOAN SPECIALTY TOOLS FOR SPECIAL JOBS!



## AUTOZONE® LOAN-A-TOOL® PROGRAM

### Over 90 Specialty Tools for Loan or Sale

We offer the most complete selection of tools for a variety of jobs, from steering and suspension, air conditioning, engine repair and more.

The best part is Loan-A-Tool® products are free to use! Leave a deposit at the store when you pick up the tool. When you're through just bring it back within 90 days, and we'll refund the deposit, or keep the tool.



Ford Triton Spark Plug Porcelain Extractor Master Set



A/C Flush Kit



Fuel Injector Puller Kit - VW/Audi

See your Commercial Sales Manager for a complete list of loaner tools.

# WELDING & CUTTING

## Welding

### Spot Welder 120V

SKU 814396 **169<sup>99</sup>**  
24819

- Convenient 120V AC Input Power
- Spot Welds Uncoated Mild Steel Including Galvanized and Stainless
- Output Current: 13.5A
- Rated Duty Cycle: 50% @ 1.5kVA



Includes  
6" Tongs and  
Replacement  
Tips

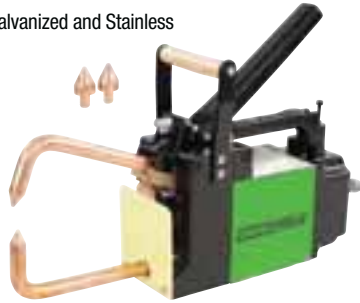

OEM TOOLS

### Stick Welder 110V (70 Amp)

SKU 814387 **129<sup>99</sup>** REG. \$149.99  
24818

- DC Inverter Powered for Improved Efficiency and Control
- Lightweight and Portable
- Welds Mild Steel, Stainless and Cast Iron
- Includes: 5' Ground Cable and Clamp, 6.5' Electrode Cable and Rod Holder, Shoulder Strap Mask and Combo Brush/Hammer

SAVE  
**\$20**



Offer Good While Supplies Last Through  
June 30, 2025

OEM TOOLS

### Flux Core Welder 110V (70 Amp)

SKU 814197 **249<sup>99</sup>**  
24817

- Rated Duty Cycle: 20% @ 70 Amps
- Adjustable Wire Feed Speed
- High and Low Output Settings
- Includes: Welding Gun and Cable, Ground Cable with Clamp, Chipping Hammer/Brush, 1 Spool of .035" Flux Core Wire and Protective Face Shield with Welding Lens



OEM TOOLS

### MIG and Flux-Core Welder (130 Amp)

SKU OUTSIDE BUY/EPO **589<sup>99</sup>**  
HSAHSW-6213

- Features Wire Speed and Power Settings by Material/Wire Thickness
- Rated Duty Cycle: 20% @ 130 Amps
- Includes: Inverter, Power Supply, Torch, Earth Clamp, Gas Regulator, Spool of .030" FluxCore Wire and Spool of .030" MIG Wire



H&S  
ADVANTAGE

## 3-in-1

### Easy Weld 140 MP

SKU OUTSIDE BUY/EPO **579<sup>99</sup>**  
FRN271

- 3-in-1 Machine (Stick/MIG/TIG, TIG Torch not Included)
- Input: 120V | Output Voltage: 12-23V | Output Current Range: 43-110A
- Duty Cycle: Stick 30% @ 80A, MIG 30% @ 90A and TIG 30% @ 110A
- Includes: 10' MIG Gun, 8' Electrode Holder, 8' Ground Clamp, 20A-15A Adaptor and One Additional .030 in Contact Tip
- No Gas Required



NEW

Forney

### 190 MP MIG Stick TIG Welder

SKU OUTSIDE BUY/EPO **1,299<sup>99</sup>**  
FRN323

- 4-in-1 Multi-Process Machine (MIG/Stick/Flux-Core/DC TIG, TIG Torch Not Included)
- Amperage Range (MIG): 120V: 30A-120A | 240V: 30A-200A
- Amperage Range (Stick): 120V: 10A-80A | 240V: 10A-190A
- Amperage Range (TIG): 120V: 10A-85A | 240V: 10A-190A
- Includes: 6' Power Cable, 8' Stick Electrode Holder, 8' Ground Cable and Clamp, 120V-240V Adapter Cord, 6' Gas Hose, 10' MIG Gun, Gas Regulator, Spare .030" and .035" Tips



NEW

To Confirm Price, Availability and Ordering Instructions on Outside Buy/EPO,  
Call 901-300-4878

## Plasma Cutter

### Flex 30™ Plasma and Stick/Tig Welder

SKU OUTSIDE BUY/EPO **1,099<sup>99</sup>**  
FRN320

- Cut and Weld Up to 3/8" Thick Material with One Small, Powerful Machine
- Amperage Range (TIG): 120V: 10A-85A | 240V: 10A-160A
- Amperage Range (Stick): 120V: 10A-80A | 240V: 10A-160A
- Amperage Range (Plasma): 120V: 10A-20A | 240V: 10A-30A
- Includes: Forney Flex 30™ Plasma ST Machine, Additional Set of Consumables, 6' Power Cable, 8' Stick Electrode Holder, 8' Ground Cable and Clamp, 15' Plasma Torch and 120V-240V Adapter Cord (TIG Torch Not Included)



NEW

Forney

## Acetylene Torch

### Medium Duty Torch Kit

SKU OUTSIDE BUY/EPO **249<sup>99</sup>**  
FRN1705

- Cuts Up to 150 mm (5.91") and Welds Up to 9 mm (0.35") with Proper Tips
- Includes: 250-Series Regulators, 100-Series Torch Handle, 1350-Series Cutting Attachment, 0-3-101 Cutting Tip, W-1-0 Welding Tip, 1/4" (6.35 mm) X 12.5' (3.81 m) Twin Welding Hose with Fittings, #5 Goggles, Round Single Flint Striker, 13-Piece Tip Cleaner and Plastic Carry Case



Forney

NEW

## Welding Cart

### Portable Welding Cart

SKU OUTSIDE BUY/EPO **119<sup>99</sup>**  
FRN332

- Steel Construction
- Dimensions: 11-1/2" (W) x 27-1/2" (H)
- Weight Capacity: 90 Lb. (40.8 Kg)
- Sleek Black Finish for a Professional Look



Forney

NEW



# WELDING & CUTTING

TO ORDER, contact your Commercial Sales Manager or go to [AutoZonePro.com](http://AutoZonePro.com)

WELDING & CUTTING

## Welding Helmets



### Valor Auto-Darkening Welding Helmet

SKU OUTSIDE BUY/EPO  
FRN55861

**99<sup>99</sup>**

**NEW**

- 5.97 Sq. In. (3.62" x 1.65") Viewing Area
- 2 Optical Arc Sensors
- 1/1 1/2 Optical Clarity Rating
- UV/IR Coating to Reduce Scratching and Discoloration of the Lens
- DIN 9 to 13 Variable Shade Selection
- 1/25,000 Per Second Switching Speed



### Auto Darkening Welding Helmet

SKU 362974  
24357

**54<sup>99</sup>**

- TIG Rated Variable Shade 9 to 13
- Viewing Area: 3.54" x 1.37"
- Battery Powered with Solar Assist
- Includes: Replacement Cover Lenses



## Soldering

### Mechanics Butane Mini Torch

SKU 804655  
24353

**17<sup>99</sup>**

- Adjustable Flame Lights Upside Down
- Auto Ignition, Refillable
- Safety Lock When Not in Use



Butane Not Included

### Mechanics Butane Torch

SKU 802236  
24354

**22<sup>99</sup>**

- Heavy Duty Piezo Ignition with Strong Flame



Butane Not Included

### Professional 3-in-1 Butane Soldering Iron Kit

SKU 420338  
24355

**34<sup>99</sup>**

- Includes: Soldering Iron, Metal Tip Wicking Cup with Sponge, Solder Wire, Protective Tip Cap, Heat-Shrink Deflector, Chisel Point Tip, Anvil Solder Tip, Needle Tip and Hot Air/Soldering Tip
- Cable Free



### Auto Darkening Welding Helmet with Grinding Function

SKU 347233  
24358

**69<sup>99</sup>**

- TIG Rated Variable Shade 9-13
- Variable Sensitivity and Delay Controls
- 2 Independent Arc Sensors
- Grinding Function
- Lens Darkening is 1/25,000
- Battery Powered with Solar Assist
- Includes: Replacement Cover Lenses
- Viewing Area: 3.62" x 1.65"



### Premium Welding Helmet - Gray Matter

SKU 1400038  
JAS47102

**119<sup>99</sup>**

- 6.24 Sq. Inch Viewing Area
- Auto Darkening Filter Meets 1/1 1/1 Optical Clarity Standard, the Highest in the Industry
- Powered By Solar Technology and (1) CR2032 Lithium Battery



## Welding Accessories

### Welder's Combo Pack

SKU 459159  
SHA14526

**54<sup>99</sup>**



- Includes: Heavy Duty Welding Gloves, Quilted Welder's Skull Cap and Oxy-Acetylene Lighter



### Multi-Purpose Welding Gloves

SKU OUTSIDE BUY/EPO  
FRN53415

**29<sup>99</sup>**

- Size: Men's Large
- Ultra-Soft Premium Goatskin Leather
- Back of the Hand is Lined for Extra Defense from Heat, Palm is Unlined for Dexterity and Finger Control



### Welder Start-Up Kit

SKU OUTSIDE BUY/EPO  
FRN377

**59<sup>99</sup>**

- Bandit Flip Front Welding Helmet with Fully Adjustable Ratcheting Headgear
- Leather Welding Gloves
- Chipping Hammer with Anti-Shock Handle
- Carbon Steel Scratch Brush



### Professional 3-in-1 Butane Micro Torch Kit

SKU 420339  
24356

**39<sup>99</sup>**

- 3-in-1 Design Can Be Used as a Soldering Iron, Torch or Hot Air Blower without Iron Tip
- Micro Torch Kit Includes: Torch, Metal Tip Wicking Cup with Sponge, Heat-Shrink Deflector, Chisel Point Tip, Anvil Solder Tip, Needle Tip and Hot Air/Soldering Tip and Base
- Ideal for Use with Electrical Repair, Tin and Plastic Melting, Heat-Shrinkable Tubing, Auto Repair, Hobby Repair and Jewelry Repair
- Power Range: 30W to 125W



Butane Not Included

### Professional Soldering Gun Kit

SKU 1362003  
24773

**39<sup>99</sup>**

REG. \$49.99

- Includes: Heavy Duty 230/150-Watt Soldering Gun, General Purpose Soldering Tip, Plastic Cutting Tip and 0.5 Oz. (14 g) Rosin Core Solder
- Reaches Max. Temperature of 937°F at Low Power
- Reaches Max. Temperature of 1400°F at High Power
- 120V, 150/230W, 60 Hz

**SAVE \$10**



Offer Good While Supplies Last Through June 30, 2025

## Consumables

### E71T-GS Flux-Core Welding Wire 0.030" 2 Lb.

SKU OUTSIDE BUY/EPO  
FRN42300

**24<sup>99</sup>**

- Tensile Strength: 79,000 psi
- Weight: 2 Lb.
- Recommended Polarity: DCEN Straight
- No Shielding Gas Required



### ER70S-6 MIG Welding Wire 0.030" 10 Lb.

SKU OUTSIDE BUY/EPO  
FRN42286

**49<sup>99</sup>**

- Tensile Strength: 70,000 psi
- Weight: 10 Lb.
- Recommended Polarity: DCEP Reverse Polarity
- Required Shielding Gas: Argon/CO2

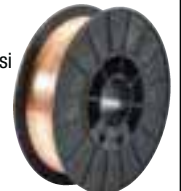

### E71T-GS Flux-Core Welding Wire 0.035" 2 Lb.

SKU OUTSIDE BUY/EPO  
FRN42302

**24<sup>99</sup>**

- Tensile Strength: 79,000 psi
- Weight: 2 Lb.
- Recommended Polarity: DCEN Straight
- No Shielding Gas Required

**NEW**



To Confirm Price, Availability and Ordering Instructions on Outside Buy/EPO, Call 901-300-4878

Prices subject to change without notice. Prices do not include applicable taxes, vehicles, tires, rims, installation or optional equipment as shown. Please do not return purchases to the store. For information regarding warranty, repair, or any questions or concerns, call 901-300-4878.

AZG0225

129

# PAINT & BODY

## Dent Repair

### Adjustable Bumper Stand

SKU **OUTSIDE BUY/EPO** **219<sup>99</sup>**  
ATD6572

- Holds Any Plastic Bumper Cover without Touching the Painted Surface
- Cover Can Be Rotated 90° to Ensure Proper Paint Coverage
- 5 Locking Positions
- Protective Rubber Boots Keep Critical Areas Free of Overspray
- 4 Industrial Grade Casters with 2 Locking for Zero Movement

For Outside Buy/EPO, Call 901-300-4878



## Body Repair

### Fast Action Body Repair Kit

- Includes: Hydraulic Pump, Hydraulic Ram, 4 Extension Rods, a Rubber Ball Foot and a Duckbill Hydraulic Spreader
- Features a Faster Double-Action Hydraulic Pump
- Includes: Blow Mold Case

**4 Ton**  
SKU **301327** **179<sup>99</sup>**  
24820

**10 Ton**  
SKU **301328** **199<sup>99</sup>**  
24821



### 3 Piece Body Seam Splitter Set

SKU **265129** **38<sup>99</sup>**  
25337

- Includes: Straight, 30° Offset and 90° Angle Seam Splitters
- Tough Chrome Vanadium Steel
- GoThru® Shafts
- Shock Dampening Grip Provides Comfort



## Dent Puller



### Slide Hammer Dent Puller Set

SKU **265148** **129<sup>99</sup>**  
25922

- 12 Lb. Hammer, Slide Hammer Shaft, Slide Hammer Handle, Slide Hammer Adapter, Deep Hook, Short Hook, Door Edge Tool, Claw, Straight Driver, Hook and Chain, Sheet Metal Screw and Holder, Nose Piece with Screw
- Comes in a Blow Mold Case



## Windshield Tool



### 18" Professional Windshield Knife

SKU **480782** **29<sup>99</sup>**  
CAL53100

- Constructed of Heavy Duty Steel and Aluminum with a Padded Ergonomic Handle



## Hood Props

### Telescopic Hood Support

SKU **420337** **19<sup>99</sup>**  
24211

- Simple Turn Locks and Unlocks the Support in Place
- Rubber End Caps Protect Vehicle's Finish
- 21" When Closed and Almost 48" When Fully Extended
- Compact and Easy to Store, Easy to Use

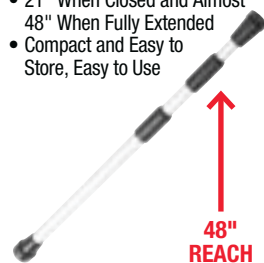

48" REACH



### Universal Lift Support Clamp

SKU **191671** **29<sup>99</sup>**  
25307

- Securely Holds Weak Lift Supports in the Extended Position to Allow Access to the Engine Compartment or Luggage Area



## Headlight Tools



### Headlamp/Taillight Removal Tool Set

SKU **1485047** **49<sup>99</sup>**  
HSAUNI-7800

- Features Two Lever Arms and Two Feeler Locator Strips
- Allows Removal of Modules Without Breaking Off Tabs
- Won't Scratch Surface Paint
- Allows for Quick Removal and Snap-In Replacement



## Door Tools



### Door Spring Tool

SKU **447118** **11<sup>99</sup>**  
25336

- Quickly and Easily Remove or Install Door Hinge Springs
- Designed for GM Cars and Light Trucks



### Panel and Trim Clip Pliers

SKU **447154** **24<sup>99</sup>**  
25930

- Designed to Remove Panel Clips
- Constructed with a Durable Chrome Plated Alloy Steel
- 2-Step Tip Minimizes Risk of Clip Damage
- Ergonomic Comfort Grip Handles for Reduced User Fatigue



### 5 Piece Door Panel and Trim Remover Set

SKU **989263** **39<sup>99</sup>** **SAVE \$6**  
25312 REG. \$45.99

- Comprised of 3 Door Panels and 2 Trim Tools
- Textured, Comfortable Grips with Thumb Stop and Hanging Hole

Offer Good Through June 30, 2025



### 6 Piece Door Panel and Trim Removal Set

SKU **003868** **49<sup>99</sup>** **SAVE \$10**  
25301 REG. \$59.99

- Includes: V-Notch Clip Remover, U-Notch Clip Remover, 2 Door Panel Removal Tools, C-Type Clip Removal Tool and Handle Clip Removal Tool

Offer Good Through June 30, 2025

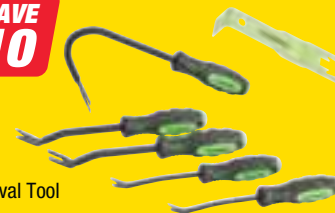

## Trim Tools

### Air Bag Release Tool for GM

SKU **191678** **19<sup>99</sup>** • Fits Most GM Cars, Minivans and Light Trucks  
25310 • Tips are Tapered to Make Removal Easier



### Trim Fastener and Molding Remover Set

SKU **900801** **14<sup>99</sup>**  
25314

- Includes: 5 Tools for Easy Removal of Fasteners, Molding, Wheel Hubs and More
- For Use on Internal and External Vehicle Molding and Trim Fasteners



### 3 Piece Light Duty Smoothing/Prying Kit

SKU **004111** **22<sup>99</sup>**  
25084

- Pry Dashboard Parts and Vents without Damaging Interior
- Clean Crevices and Joints in Small Electronics
- Disassemble Key Fobs and Other Remotes
- Evenly Smooth Epoxy and Adhesives

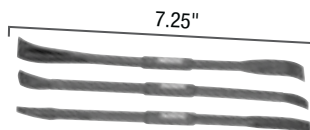

7.25"

### Door Hinge Adjuster

SKU **447144** **84<sup>99</sup>**  
25946

- Adjusts Door Hinge Position on Most Vehicles
- 2-Head Adapter Works with Large and Small Latches
- Excellent Grip for Ease of Use
- Provides Leverage to Get the Job Done



# HAND TOOLS

TO ORDER, contact your Commercial Sales Manager or go to [AutoZonePro.com](http://AutoZonePro.com)

HAND TOOLS

## Combo Wrench Sets

### RingStop® Reversible Ratcheting Wrench Set

- Patented RingStop® Design Makes One-Hand Use Easy
- Posi-Grip No-Slip® Design
- Jaw is 15° Offset
- Made with Chrome Vanadium Steel



Go Thru Ratcheting Head



### Flex Head Flare Nut Wrench Set



#### 5 Piece (SAE)

SKU 749849 **69<sup>99</sup>**  
22063

- 1/4" x 5/16", 3/8" x 7/16", 1/2" x 9/16", 5/8" x 11/16", 3/4" x 7/8"

**BONUS VALUE: \$9.99**

### Medium Fuel Line Hose Clamp

25379

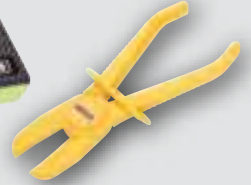

### 8 Piece Set (SAE)

SKU 803139  
23989 **99<sup>99</sup>**

- SAE Sizes: 5/16", 3/8", 7/16", 1/2", 9/16", 5/8", 11/16" and 3/4"



10" Width x 7.8" Depth

### 12 Piece Set (Metric)

SKU 803140  
23988 **149<sup>99</sup>**

- Metric Sizes: 8, 9, 10, 11, 12, 13, 14, 15, 16, 17, 18 and 19 mm



15" Width x 10" Depth

**BONUS VALUE: \$21.99**

### 8 Piece Go Thru Socket Set (SAE)

22979



With Purchase of 23989

Offers Good While Supplies Last Through June 30, 2025

**BONUS VALUE: \$29.99**

### 12 Piece Go Thru Socket Set (Metric)

22978



With Purchase of 23988

### 6 Piece (Metric)

SKU 749930 **74<sup>99</sup>**  
22064

- 9 mm x 11 mm, 10 mm x 12 mm, 13 mm x 14 mm, 15 mm x 17 mm, 16 mm x 18 mm, 19 mm x 21 mm



With Purchase of 22063 or 22064

Offer Good While Supplies Last Through June 30, 2025

## Combo Wrench Sets

### 14 Piece (SAE)

SKU 802222 **99<sup>99</sup>**  
23993 REG. \$119.99

- 1/4", 5/16", 3/8", 7/16", 1/2", 9/16", 5/8", 11/16", 3/4", 7/8", 15/16", 1", 1-1/16" and 1-1/8"

Offer Good Through June 30, 2025

**SAVE \$20**

### 16 Piece (Metric)

SKU 802224 **119<sup>99</sup>**  
23994

- 6, 7, 8, 9, 10, 11, 12, 13, 14, 15, 16, 17, 18, 19, 21 and 22 mm



### 10 Piece Combination Wrench Set (Metric)

SKU 127920 **54<sup>99</sup>**  
22995

- Includes: 10 to 19 mm
- Posti-Grip No-Slip® Design Provides Off-Corner Loading for Greater Torque with More Socket-to-Fastener Contact
- Marked on All 4 Sides for Easy Identification

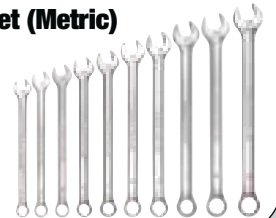

# JUMBO WRENCHES

Jumbo wrenches are made of high quality drop forged steel and are precision machined to prevent fastener damage.

Individual Jumbo Wrenches Available on [AZTOOL1.COM](http://AZTOOL1.COM)

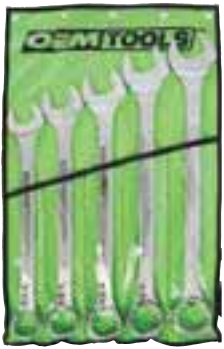

Sets Include Roll-Up Storage Bag

SKU	Part #	Metric or SAE	Size	Price
338830	22100	SAE	1-1/16", 1-1/8", 1-1/4", 1-5/16", 1-3/8" and 1-7/16"	<b>89.99</b>
338833	22101	SAE	1-1/2", 1-5/8", 1-3/4", 1-7/8" and 2"	<b>119.99</b>
338852	22120	Metric	21 mm, 22 mm, 24 mm, 25 mm, 27 mm, 29 mm, 30 mm and 32 mm	<b>74.99</b>
338858	22121	Metric	33 mm, 34 mm, 35 mm, 36 mm, 40 mm, 42 mm, 46 mm, 50 mm	<b>139.99</b>

Box End Offset 15° for Work in Tight Spaces

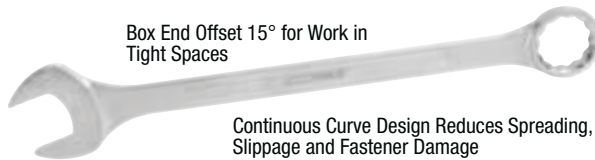

Continuous Curve Design Reduces Spreading, Slippage and Fastener Damage

SKU	Part #	SAE Size	Price
338859	22102	1-1/16"	<b>15.99</b>
338864	22103	1-1/8"	<b>17.99</b>
338866	22104	1-1/4"	<b>19.99</b>
338868	22105	1-5/16"	<b>21.99</b>
338877	22106	1-3/8"	<b>23.99</b>
338890	22107	1-7/16"	<b>25.99</b>
338896	22108	1-1/2"	<b>27.99</b>
338898	22109	1-5/8"	<b>29.99</b>
338903	22110	1-3/4"	<b>31.99</b>
338935	22111	1-7/8"	<b>34.99</b>



## Jumbo Angle Wrench Set

### 6 Piece Jumbo Angle Head Wrench Set

SKU OSB/EPO **99<sup>99</sup>**  
22113

- Sizes: 1-3/8", 1-1/2", 1-5/8", 1-3/4", 1-7/8" and 2"



Include Roll-Up Storage Bag

For Outside Buy/EPO, Call 901-300-4878



## Ratcheting Combination Wrenches

### 16 Piece 12 Pt. Ratcheting Combination Wrench Set (Metric)

SKU 213125 **189<sup>99</sup>**  
KDT9416

- Includes: 8, 9, 10, 11, 12, 13, 14, 15, 16, 17, 18, 19, 20, 21, 22 and 24 mm
- Ratcheting Box End Requires Only 5° to Move Fasteners
- 12 Point Design Providing More Positions to Engage the Fastener

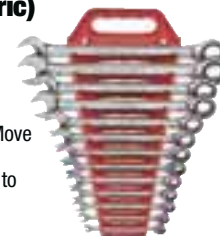

## Wrench Extender

### Wrench Extender

SKU 1368628 **36<sup>99</sup>**  
22656

- Safely Provides Extra Leverage to Loosen Rusted Bolts, Jammed Fasteners or Over-Tightened Nuts
- Great for Use on Those Hard to Reach Fasteners



Prices subject to change without notice. Prices do not include applicable taxes, vehicles, tires, rims, installation or optional equipment as shown. Please do not return purchases to the store. For information regarding warranty, repair, or any questions or concerns, call 901-300-4878.

# HAND TOOLS

## Screwdrivers

### 19 Piece Screwdriver Set

SKU 1142325 **29<sup>99</sup>**  
73775



- Slotted: 3/32" x 1.5", 1/8" x 2.5", 3/16" x 4", 3/16" x 8" (Cabinet Tip), 1/4" x 1.5" (Stubby), 1/4" x 4", 1/4" x 6", 5/16" x 6", 3/8" x 8"
- Phillips: #0 x 1.5", #0 x 2.5", #1 x 3", #2 x 1.5" (Stubby), #2 x 4", #2 x 8", #3 x 6", #4 x 8"
- Offset: 3/16" x #1, 1/4" x #2
- Magnetic Tips Hold Fasteners in Place
- Square Shafts Can Be Used with Wrench for More Torque
- Hexagon Shaped Handles Prevent Roll Off
- Color Coded Fluting Defines Driver Type



GreatNeck



Impact Resistant Acetate Handle  
(Fluted for Better Grip)



## Ratcheting Screwdriver

### Pivot-Grip Ratcheting Screwdriver

SKU 004103 **21<sup>99</sup>**  
22557



- Pivoting Handle Provides Ergonomic Gripping Positions
- Forward and Reverse Ratcheting
- Magnetic Bit Shaft for a Secure Fit
- Overall Length: 10"
- Internal Bit Cartridge for Convenient Storage
- Includes: 6 Bits: Phillips (#1, #2), Slotted (4 mm, 6 mm) and Robinson (#1, #2)



Internal Bit Storage Pivoting Handle Rotates from Straight-Grip to Pistol-Grip

## Long Reach Screwdrivers

- High Performance Hex Shaped Shaft for More Torque and Less Flex
- Precision Machined and Sand Blasted Tips That Reduce Cam-Out
- Durable Ergonomic Handles are Made of Hardened Resin

### 5/16" x 20" Slotted Screwdriver

SKU 1142473 **19<sup>99</sup>**  
22555



### #2 x 20" Phillips Screwdriver

SKU 1142485 **16<sup>99</sup>**  
22574

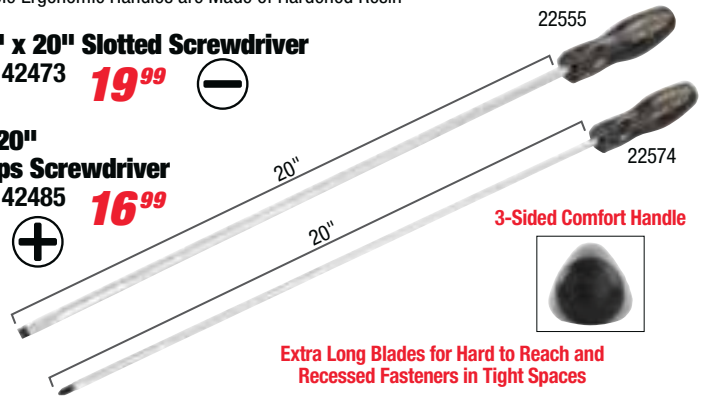

Extra Long Blades for Hard to Reach and Recessed Fasteners in Tight Spaces

### 8 Piece Mechanics Screwdriver Set

SKU 802208 **59<sup>99</sup>**  
23999 REG. \$69.99

SAVE \$10



- EVA Tray with Custom Cut Contrast Soft Foam and Sizes Marked for Easy Identification, Designed to Fit Securely in a Cabinet or Tool Box
- Features a Hard Chrome™ Finish, an Easy-to-Clean Smooth Satin Finish That Won't Show Prints and Keeps Rust Away
- Custom Cut of the Tool is a Hi-Vis Green Making it Visible if a Tool is Missing
- Slotted: 1/4" x 1-1/2", 3/16" x 3", 1/4" x 4", 5/16" x 6" and 3/8" x 8"



OEM TOOLS



Offer Good Through June 30, 2025

### 20 Piece Screwdriver Set

SKU 1142343 **39<sup>99</sup>**  
92080

GreatNeck

- Chrome Vanadium Steel Shaft for Strength and Durability
- Precision Ground Sandblasted Tip
- Highest Quality Acetate Handle
- Slotted: 3/32" x 2", 1/8" x 2", 3/16" x 4", 1/4" x 1-1/2", 1/4" x 4", 1/4" x 6"
- Phillips: #00 x 1-1/2", #0 x 2", #1 x 3", #2 x 4", #2 x 6", #2 x 1-1/2"
- Star: T15, T20
- Square: #2
- (1) Offset Screwdriver
- 4 Piece Hook and Pick Set

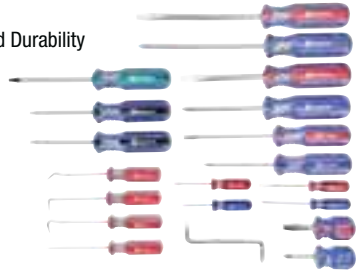

## Star Screwdrivers

### 5 Piece Star Screwdriver Set

SKU 1142630 **13<sup>99</sup>**  
73721



- Star (T10 x 4", T15 x 4", T20 x 4", T25 x 5", T30 x 6")
- Magnetic Tips Hold Fasteners in Place
- Hexagon Shaped Handles Prevent Roll Off



GreatNeck



## Gasket Scraper Set

### 3 Piece Gasket Scraper Set

SKU 1069069 **24<sup>99</sup>**  
26501

- Includes: 3/4", 1" and 1-1/2" Gasket Scrapers



OEM TOOLS

## Hex Key Sets

### 27 Piece Star and Hex Key Set (Metric and SAE)

SKU 1209375 **59<sup>99</sup>**  
24299

- Extra Long Arm for Accessing Hard-to-Reach Spots
- Each Tool is Color Coded and Marked with Sizes for Easy Identification
- SAE and Metric Hex Keys Have Ball-End Design for Reaching at Angles Up to 25°



S2  
STEEL



- Manganese Phosphate Finish Resists Corrosion
- 25° Entry Angle for Better Work Near Obstructions
- Long Arms Provide for Increased Torque and Extra Reach

### 35 Piece SAE, Metric and Star

SKU 1168819 **31<sup>99</sup>**  
24249



### 26 Piece SAE and Metric

SKU 1168833 **24<sup>99</sup>**  
24248

S2  
STEEL



### 9 Piece Magnetic Long Arm Hex Key Set Long - SAE

SKU 978109 **22<sup>99</sup>**  
24261 REG. \$27.99

- Includes SAE Sizes: 1/16", 5/64", 3/32", 1/8", 5/32", 3/16", 1/4", 5/16" and 3/8" Color Coded Red - SAE
- Magnetic Tips Hold Fasteners in Place and Prevents Them from Slipping

SAVE \$5



Offer Good Through June 30, 2025

# HAND TOOLS

TO ORDER, contact your Commercial Sales Manager or go to [AutoZonePro.com](http://AutoZonePro.com)

HAND TOOLS

## 10 mm Socket Set

### 10 Piece 10 mm Master Socket Set (Metric)

SKU 1267951 **24<sup>99</sup>**  
22463

- Magnetic Impact Sockets are Constructed with Chrome Molybdenum for Strength and Durability
- Includes: (5) 1/4" Drive Sockets and (5) 3/8" Drive Sockets

10 mm  
If You Know,  
You Know

OEM TOOLS®



## Mechanics Set

### 64 Piece 1/4" Drive Metric Set

SKU 020788 **99<sup>99</sup>**  
23997

- Shallow Sockets, 6 Pt: 4 to 15 mm
- Deep Sockets, 6 Pt: 4 to 15 mm
- Drive Wobble Straight Extension
- Bit Extension Bars: 6" and 10"
- Ratchet Screwdriver
- Universal Joint
- Ratchet
- 28 Bits

EVA  
FOAM  
TRAY

OEM TOOLS®



20" Width x 8" Depth

## Ratchet and Socket Set

### 26 Piece 1/2" Drive Ratchet and Socket Set

SKU 591154 **99<sup>99</sup>**  
23995

- Includes: (21) 6 Pt. Metric and SAE Sockets (1) 1/2" Dr. Extension Bar 3" (1) 1/2" Dr. Extension Bar L6 (1) 1/2" Swivel U-Joint (1) 1/2" Dr. Regular Ratchet

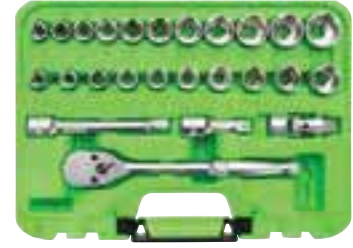

## Universal Joints

### 1/4" Drive

SKU 081225 **9<sup>99</sup>**  
22520



(Style May Vary)

### 1/2" Drive

SKU 081227 **11<sup>99</sup>**  
22522

### 3/8" Drive

SKU 081226 **10<sup>99</sup>**  
22521

OEM TOOLS®

## Socket Adapters

### 3 Piece Low-Profile Adapter Set

SKU 818570 **17<sup>99</sup>**  
22535

- CR-V Steel for Strength
- Get into Tighter Spaces
- Includes: 1/4" F x 3/8" M, 3/8" F x 1/2" M, and 1/2" F x 3/4" M



## Adapters

- Hard Chrome™ Finish is Easy to Clean and Will Keep Away Rust

HARD CHROME™ FINISH

OEM TOOLS®



22534

SKU	Part #	Drive	Price
81228	22530	1/2" F x 3/4" M	<b>14.99</b>
81229	22531	1/2" F x 3/8" M	<b>10.99</b>
81230	22532	3/8" F x 1/2" M	<b>7.99</b>
81232	22533	3/8" F x 1/4" M	<b>6.99</b>
81233	22534	1/4" F x 3/8" M	<b>7.99</b>

## Socket Sets

- Posi-Grip No-Slip®
- Off Corner Loading for Greater Torque
- Knurling Position for Best Finger Gripping

- Chamfered Ends Allow the Socket to Easily Slip Over the Bolt Head
- Deep Marking for Easy Identification



### 1/4" Drive Socket Sets

#### 10 Piece (SAE)

SKU 127786 **21<sup>99</sup>**  
22952

- 3/16" to 9/16"

#### 12 Piece (Metric)

SKU 127836 **25<sup>99</sup>**  
22950

- 5 mm to 15 mm

#### 10 Piece Deep (SAE)

SKU 1414402 **26<sup>99</sup>**  
22953A

- 3/16" to 9/16"

#### 12 Piece Deep (Metric)

SKU 127772 **30<sup>99</sup>**  
22951

- 5 to 15 mm



### 10 Piece 1/4" Deep (SAE)

SKU 850056 **24<sup>99</sup>**  
23985

- Includes: 3/16" to 9/16"

### 12 Piece 1/4" Deep (Metric)

SKU 850510 **24<sup>99</sup>**  
23986

- Includes: 5 mm to 15 mm

10" Width x 4" Depth



OEM TOOLS®

EVA  
FOAM  
TRAY

### 3/8" Drive Socket Sets

#### 11 Piece (SAE)

SKU 127798 **32<sup>99</sup>**  
22956

- 1/4" to 7/8"

#### 12 Piece (Metric)

SKU 127794 **35<sup>99</sup>**  
22954

- 8 mm to 19 mm

#### 11 Piece Deep (SAE)

SKU 127803 **37<sup>99</sup>**  
22957

- 1/4" to 7/8"

#### 12 Piece Deep (Metric)

SKU 127797 **40<sup>99</sup>**  
22955

- 8 mm to 19 mm



### 12 Piece 3/8" Deep Socket Set (Metric)

SKU 103402 **34<sup>99</sup>**  
23981

- Includes: 8 mm to 19 mm

EVA  
FOAM  
TRAY

10" Width x 7" Depth



### 1/2" Drive Socket Sets

#### 11 Piece (SAE)

SKU 127812 **39<sup>99</sup>**  
22960

- 1/2" to 1-1/8"

#### 10 Piece (Metric)

SKU 127807 **35<sup>99</sup>**  
22958

- 10 mm to 19 mm

#### 11 Piece Deep (SAE)

SKU 127846 **45<sup>99</sup>**  
22961

- 1/2" to 1-1/8"

#### 10 Piece Deep (Metric)

SKU 127809 **40<sup>99</sup>**  
22959

- 10 mm to 19 mm



### 24 Piece 3/8" Dr. Socket Set (Metric)

SKU 127868 **49<sup>99</sup>**  
22963

- Includes: 8-19 mm (Deep) and 8-19 mm (Shallow)

### 22 Piece 3/8" Drive Socket Set (SAE)

SKU 127869 **44<sup>99</sup>**  
22962

- Includes: 1/4" to 7/8" (Deep); 1/4" to 7/8" (Shallow)



Prices subject to change without notice. Prices do not include applicable taxes, vehicles, tires, rims, installation or optional equipment as shown. Please do not return purchases to the store. For information regarding warranty, repair, or any questions or concerns, call 901-300-4878.

# HAND TOOLS

## Ratchets

- 36 Teeth with 10° Arc Motion for Precision and Strength
- Reversing Lever Allows a Forward and Reverse in One-Hand Action
- Sealed to Keep Dirt and Debris Out of Head
- Compact Head Designed to Get into Tight Spaces

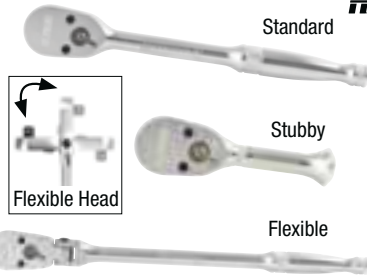

## HARD CHROME™ FINISH OEM TOOLS®

SKU	Part #	Type	Drive	Length	Price
081298	22900	Standard	1/4"	4-1/4"	<b>18.99</b>
177728	22911	Standard	3/8"	8"	<b>34.99</b>
177768	22920	Standard	1/2"	10"	<b>43.99</b>
177702	22910	Stubby	3/8"	4"	<b>33.99</b>
081301	22901	Flexible	1/4"	6"	<b>29.99</b>
177730	22912	Flexible	3/8"	11-1/2"	<b>42.99</b>
177769	22921	Flexible	1/2"	17-1/2"	<b>45.99</b>

## Extensions

## OEM TOOLS®

- Chamfered Ends for Positive Engagement with Drive Tools
- Knurled Shank for Easy Fingertip Turning
- Milled Ends Provide a Solid Connection

SKU	Part #	Drive	Length	Price
081213	22481	1/4"	4"	<b>5.99</b>
081215	22482	1/4"	6"	<b>7.99</b>
081218	22483	1/4"	11"	<b>9.99</b>
081219	22490	3/8"	1-3/4"	<b>9.99</b>
081220	22491	3/8"	4"	<b>10.99</b>
306326	22492	3/8"	6"	<b>8.99</b>
306287	22494	3/8"	10"	<b>11.99</b>
081212	22480	1/2"	2"	<b>3.99</b>
081221	22500	1/2"	3"	<b>9.99</b>
081223	22501	1/2"	6"	<b>11.99</b>
081224	22502	1/2"	10"	<b>18.99</b>

## Flex Head Breaker Bars

- Special Alloy Steel, Heat-Treated to Provide Durability
- 180° Flex Head Provides Leverage at Desired Angle for Hard-to-Reach Applications

SKU	Part #	Drive	Length	Price
081302	22913	3/8"	11-9/16"	<b>14.99</b>
081303	22922	1/2"	18"	<b>24.99</b>
750437	22923	1/2"	24"	<b>29.99</b>



## Impact Driver

### 1/2" Drive Impact Driver Set

SKU 1142387 **27.99**  
22561

- Easily Break Free Rusted, Corroded and Frozen Screws
- Includes: Impact Driver, Bit Adapter, 8 Impact Bits and Sturdy Blow Mold Case



## Pocket Screwdrivers

### 5 Piece Spiral Drive Bit Set

SKU 802234 **19.99**  
22975

- Sizes: MTS0, MTS1, MTS2, MTS3 and MTS4
- 3/8" Drive

- Services New Fasteners Found on Many GM, Chrysler, BMW and Fiat Vehicles of the Mid-2000 and Later Model Range Including Bolts That Secure the Bell Housing to the Transmission on GM 4L60 Transmissions



## Triple Square Bit Sets

- Use on European Vehicles Like BMW, Mercedes, VW, Audi and Porsche
- Heat-Treated Alloy Steel Bits to Reduce Premature Wear
- Reinforced Chrome Vanadium Steel Sockets to Increase Turning Power

- Fully Refined Hard Chrome Plated Finish and Zinc Phosphate Bits Treatment to Prevent Rust and Corrosion
- Meets and Exceeds ANSI Standards

## OEM TOOLS®

### 10 Piece Extra Long XZN Triple Square Spline Bit Socket Set

SKU 1368626 **34.99**  
23519 REG. \$44.99

- Sizes Included: M4, M5, M6, M8, M9, M10, M12, (Tamper-Proof) M14, M16, M18
- Socket Length: 3.93"



Offer Good Through June 30, 2025

### 10 Piece Magnetic Long Triple Square Bit Socket Set

SKU 1313567 **44.99**  
23907

- Sizes Included: (1/4" Drive) M4, M5, M6; (3/8" Drive) M8, M9, M10, M12, M14; (1/2" Drive) M16, M18
- Socket Length: 3.93"



### 9 Piece Triple Square Bit Set

SKU 191052 **19.99**  
25953

- 1/4" Drive: M4, M5 and M6 (Length: 37 mm)
- 3/8" Drive: M8, M10 and M12 (Length: 48 mm)
- 1/2" Drive Tamper-Proof: M14, M16 and M18 (Length: 55 mm)



### 10 Piece Triple Square Bit Socket Set

SKU 1368630 **17.99**  
22711

- Sizes Included: M4, M5, M6, M8, M9, M10, M12, (Tamper-Proof) M14, M16, M18
- Comes Enclosed in Blow Mold Case for Easy Identification and Storage



### 10 Piece Magnetic Triple Square Bit Socket Set

SKU 1368615 **29.99**  
23906

- Powerful Magnetic Bits to Prevent the Loss of Nuts, Bolts and Fasteners
- Comes Enclosed in Blow Mold Case for Easy Identification and Storage
- Sizes Included: (1/4" Drive) M4, M5, M6; (3/8" Drive) M8, M9, M10, M12, M14; (1/2" Drive) M16, M18



- Constructed for Professionals with Superior Materials for Increased Torque and Hardness
- Heat-Treated S2 Steel Bits to Reduce Premature Wear

- Reinforced Chrome Vanadium Steel Sockets for Durability and Improved Finish
- Fully Refined Hard Chrome Plated Finish and Zinc Phosphate Bits Treated to Prevent Rust and Corrosion



## Hex Sets

### 12 Piece Magnetic (SAE)

SKU 1282759  
23900 **24<sup>99</sup>** REG. \$34.99

- 1/4" Drive: 1/16", 5/64", 3/32", 7/64" and 1/8"
- 3/8" Drive: 9/64", 5/32", 3/16", 7/32", 1/4", 5/16" and 3/8"

### 12 Piece Magnetic (Metric)

SKU 1282804  
23901 **24<sup>99</sup>** REG. \$34.99

- 1/4" Drive: 2 mm, 2.5 mm, 3 mm, 4 mm, 5 mm and 5.5 mm
- 3/8" Drive: 6 mm, 7 mm, 8 mm, 9 mm, 10 mm and 12 mm

### 12 Piece Magnetic Long (SAE)

SKU 1282807  
23902 **34<sup>99</sup>** REG. \$44.99

- 1/4" Drive: 1/16", 5/64", 3/32", 7/64", 1/8"
- 3/8" Drive: 9/64", 5/32", 3/16", 7/32", 1/4", 5/16" and 3/8"

### 12 Piece Magnetic Long (Metric)

SKU 1282737  
23903 **34<sup>99</sup>** REG. \$44.99

- 1/4" Drive: 2 mm, 2.5 mm, 3 mm, 4 mm and 5 mm
- 3/8" Drive: 5.5 mm, 6 mm, 7 mm, 8 mm, 9 mm, 10 mm and 12 mm

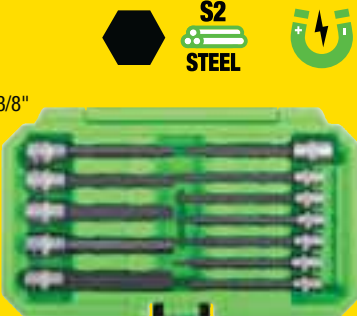
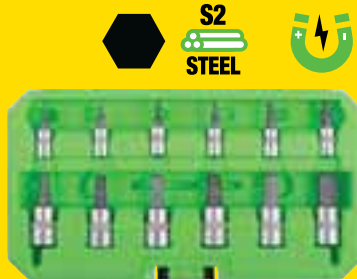

Offers Good While Supplies Last Through June 30, 2025

### 12 Piece Long (SAE)

SKU 1282747  
23563 **29<sup>99</sup>** REG. \$34.99

- 1/4" Drive: 1/16", 5/64", 3/32", 7/64" and 1/8"
- 3/8" Drive: 9/64", 5/32", 3/16", 7/32", 1/4", 5/16" and 3/8"

### 12 Piece Long (Metric)

SKU 1282757  
23538 **29<sup>99</sup>** REG. \$34.99

- 1/4" Drive: 2 mm, 2.5 mm, 3 mm, 4 mm and 5 mm
- 3/8" Drive: 5.5 mm, 6 mm, 7 mm, 8 mm, 9 mm, 10 mm and 12 mm

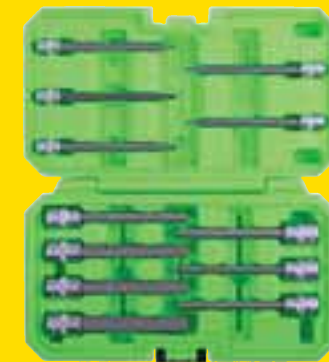

Offers Good Through June 30, 2025

### 32 Piece Hex Bit Socket Set (SAE and Metric)

SKU 1282740  
22989 **39<sup>99</sup>**

#### SAE

- 1/4" Drive: 1/8", 5/32", 3/16", 7/32" and 1/4"
- 3/8" Drive: 9/32", 5/16", 3/8", 7/16" and 1/2"
- 1/2" Drive: 9/16", 5/8", 11/16" and 3/4"

#### Metric

- 1/4" Drive: 2, 2.5, 3, 4, 5, 5.5 and 6 mm
- 3/8" Drive: 7, 8, 9, 10 and 12 mm
- 1/2" Drive: 14, 15, 17 and 19 mm



### 26 Piece Master Hex Bit Set

SKU 802219  
23990 **46<sup>99</sup>**

- Includes: 1/4" Drive Sizes: 1/8" to 7/32" and 2.5 to 5 mm, 3/8" Drive Sizes: 1/4" to 11/32" and 6 to 9 mm, 1/2" Drive Sizes: 3/8" to 5/8" and 10 to 19 mm



### 1/2" Drive Hex Bit Set (Metric)

SKU OUTSIDE BUY/EPO  
25417 **14<sup>99</sup>**

- Sizes: 12, 14 and 17 mm
- Use on Transmission and Differential Drain Plugs

For Outside Buy/EPO,  
Call 901-300-4878



### 7 Piece Hex Bit Set (SAE)

SKU 127904  
22982 **24<sup>99</sup>**

- 3/8" Drive: 5/16" and 3/8"
- 1/2" Drive: 7/16", 1/2", 9/16", 5/8" and 3/4"



### 1/2" Drive Metric Hex Bit Socket Set (7 Piece)

SKU 1168830  
22998 **29<sup>99</sup>**

- Includes: 13, 14, 15, 17, 19, 21 and 22 mm



### 9 Piece Hex Bit Set (Metric)

SKU 127903  
22983 **29<sup>99</sup>**

- Includes: 1/4" Drive 2, 2.5, 3, 4 mm and 3/8" Drive 5, 6, 7, 8, 10 mm
- Knurling Position is Optimized for Best Finger Gripping Position



### 1/2" Drive SAE Hex Bit Socket Set (6 Piece)

SKU 1168826  
22999 **24<sup>99</sup>**

- Includes 9/16", 5/8", 11/16", 3/4", 13/16" and 7/8"
- Tempered Chrome Vanadium Steel with a Plated Finish for Long Life



### 12 Piece Hex Bit Set (SAE)

SKU 127905  
22984 **27<sup>99</sup>**

- Includes: (1/4" Drive) 1/16", 5/64", 3/32", 7/64", 1/8"; (3/8" Drive) 9/64", 5/32", 3/16", 7/32", 1/4", 5/16", 3/8"
- Knurling Position is Optimized for Best Finger Gripping Position



# HAND TOOLS

## Multi-Drive Sets

### 35 Piece Multi-Drive Star Socket Set

SKU 802217 **49<sup>99</sup>**  
23991

- 1/4" Drive Star: T10, T15, T20, T25, T27 and T30
- 1/4" Drive Tamper-Proof Star: T7, T8, T9, T10, T15, T20, T25 and T30
- 1/4" Drive Female Star: E4, E5, E6, E7 and E8
- 3/8" Drive Tamper-Proof Star: T40, T45, T50 and T55
- 3/8" Drive Star: T40, T45, T47, T50 and T55
- 3/8" Drive Female Star: E10, E12, E14 and E16
- 1/2" Drive Star: T60 and T70
- 1/2" Drive Female Star: E18

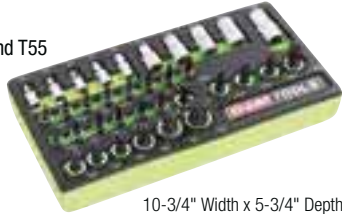

10-3/4" Width x 5-3/4" Depth



### 44 Piece Multi-Drive Star and Bit Socket Set

SKU 802206 **54<sup>99</sup>**  
23992

- 1/4" Bit Holder
- 1/4" Hex Drive Tamper-Proof Star Bits: T7, T8, T9, T10, T15, T20, T25, T27, T30
- 1/4" Hex Drive Star: T10, T15, T20, T25, T27 and T30
- 3/8" Drive Star: T40, T45, T47, T50, T55 and T60
- 3/8" Drive Metric Hex: 2, 2.5, 3, 4, 5, 6, 7, 8 and 10 mm
- 3/8" Drive SAE Hex: 1/8", 5/32", 3/16", 7/32", 1/4", 5/16" and 3/8"
- 3/8" Drive Phillips: #1, #2 and #3
- 3/8" Drive Slotted: 3/16", 1/4" and 5/16"

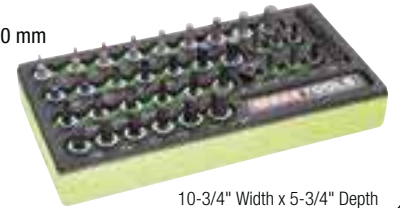

10-3/4" Width x 5-3/4" Depth



## Star Sets

### 13 Piece Tamper-Proof

SKU 1282735 **19<sup>99</sup>**  
22710 REG. \$24.99

- 1/4" Drive: T8, T10, T15, T20, T25, T27 and T30
- 3/8" Drive: T40, T45, T47, T50 and T55
- 1/2" Drive: T60

**SAVE \$5**

### 13 Piece Star Bit Socket Set

SKU 1282806 **19<sup>99</sup>**  
22977 REG. \$24.99

- 1/4" Drive: T8, T10, T15, T20, T25, T27 and T30
- 3/8" Drive: T40, T45, T47, T50 and T55
- 1/2" Drive: T60



Offers Good While Supplies Last Through June 30, 2025

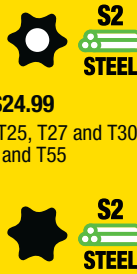

### 13 Piece Magnetic

SKU 1267957 **34<sup>99</sup>**  
23904

- 1/4" Drive: T8, T10, T15, T20, T25, T27 and T30
- 3/8" Drive: T40, T45, T47, T50, T55 and T60

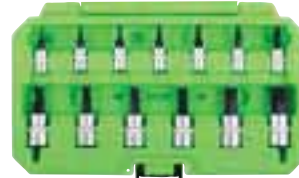

### 13 Piece Extra Long

SKU 1282758 **39<sup>99</sup>**  
23680 REG. \$49.99

- 1/4" Drive: T8, T10, T15, T20, T25, T27 and T30
- 3/8" Drive: T40, T45, T47, T50, T55 and T60

**SAVE \$10**

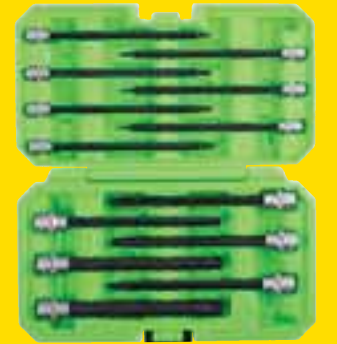

Ratchet Not Included

OEM TOOLS

### 35 Piece Master Star Bit Set

SKU 466622 **49<sup>99</sup>**  
25951

- 1/4" Drive Star: T8 to T30
- 1/4" Drive Tamper-Proof Star: T7, T8, T9, T10, T15, T20, T25 and T30
- 1/4" Drive Female Star: E4, E5, E6, E7 and E8
- 3/8" Drive Star: T40, T45, T47, T50 and T55
- 3/8" Drive Tamper-Proof Star: T40, T45, T50 and T55
- 3/8" Drive Female Star: E10, E12, E14 and E16
- 1/2" Drive Star: T60



### 13 Piece Magnetic Long

SKU OUTSIDE BUY/EPO  
23905

**34<sup>99</sup>** REG. \$44.99

- 1/4" Drive: T8, T10, T15, T20, T25, T27 and T30
- 3/8" Drive: T40, T45, T47, T50, T55 and T60



**SAVE \$10**

For Outside Buy/EPO,  
Call 901-300-4878

Offers Good While Supplies Last Through June 30, 2025

### 11 Piece Tamper-Proof Star Set

SKU 127872 **19<sup>99</sup>**  
22972 REG. \$25.99

- Includes: (1/4" Drive) T8, T10, T15, T20, T25, (3/8" Drive) T27, T30, T40, T45, T47, T50
- Knurling Position is Optimized for Best Finger Gripping Position
- Black Oxide Finish Indicates Star Drivers



Offer Good While Supplies Last  
Through June 30, 2025

### 12 Piece Tamper-Proof Star Set

SKU 127870 **29<sup>99</sup>**  
22971

- Includes: (1/4" Drive) T8 to T25; and (3/8" Drive) T27 to T55
- Knurling Position is Optimized for Best Finger Gripping Position -- Go Ahead and Put On Serious Torque, it Won't Slip
- Black Oxide Finish Indicates Star Drivers
- Chamfered Ends Allow the Socket to Easily Slip Over the Bolt Head
- Makes Fastener Engagement Quick and Smooth



### Stubby Star Drive Sets

SKU 447157 **29<sup>99</sup>**  
24293

- 1/4" Drive: T7, T8, T9, T10, T15, T20, T25, T27, T30, T40, T45, T47 and T50



### 13 Piece Tamper-Proof

SKU 447156 **29<sup>99</sup>**  
24294

- 1/4" Drive: T7H, T8H, T9H, T10H, T15H, T20H, T25H, T27H, T30H, T40H, T45H, T47H and T50H





# HAND TOOLS

TO ORDER, contact your Commercial Sales Manager or go to [AutoZonePro.com](http://AutoZonePro.com)

HAND TOOLS

## Pro Series Pliers Sets



### 3 Piece Groove Joint Pliers Set

SKU 662761  
22648 **39<sup>99</sup>** REG. \$49.99

- Sizes: 8", 10" and 12"
- Gripping Capacity: 8" (1.25"), 10" (1.80"), 12" (2.25")

**SAVE \$10**



Offer Good Through June 30, 2025

### 3 Piece Mechanics Pliers Set

SKU 662748  
22647 **44<sup>99</sup>**

- Pliers and Sizes: 7" Diagonal Pliers, 8" Linesman Pliers, 10" Speed-Fit Pliers



## Locking Pliers



- For Clamping and Gripping in Tight Spaces
- Constructed with Heat-Treated Alloy Steel
- Precision-Machined Jaws Feature Hardened Teeth to Provide a Sure Grip from Any Angle
- Instant Locking and Release Mechanism for Improved Control
- Nickel Chrome Plated to Resist Rust

### 7 Piece Locking Pliers Set

SKU 012622  
23987 **89<sup>99</sup>**

- Sizes: 4", 5", 7", 10" Curved Jaw and 4", 6", 9" Long Nose



15" Width x 10" Depth



23987

#### Curved Jaw



22635

#### Long Nose



22637

#### Chain



22642

#### C-Clamp



22641

SKU	Part #	Type	Size	Price
081256	22635	Curved Jaw	4"	<b>7.99</b>
081257	22636		5"	<b>14.99</b>
081261	22638		7"	<b>12.99</b>
081263	22640		10"	<b>18.99</b>
081260	22637	Long Nose	6-1/2"	<b>9.99</b>
081262	22639		9"	<b>12.99</b>
081267	22642	Chain	19"	<b>19.99</b>
081265	22641	C-Clamp	11"	<b>14.99</b>

## Diagonal Pliers



### 6-1/2" High Leverage Diagonal Pliers

SKU 081240  
22614 **12<sup>99</sup>** TECREADY GRIPS

- High Leverage Design for Gripping, Bending and Cutting Tasks



## Extended Reach Pliers



### 11" Long Reach Long Nose Pliers

- Constructed with Durable Heat-Treated Alloy Steel
- Precision-Machined Jaws Provide Improved Grip
- TecReady Grip Handles Reduce User Fatigue
- Nickel Chrome Plated to Resist Rust

#### Straight

SKU 081249  
22621 **15<sup>99</sup>**

#### 45°

SKU 081250  
22622 **15<sup>99</sup>**

#### Duck Bill

SKU 213108  
22644 **15<sup>99</sup>**



(Color May Vary)

### 11" Hose Gripper Pliers Set (3 Piece)

SKU 94811  
L311L **24<sup>99</sup>**

- Sizes: 5/16", 1/2" and 3/4" Constructed with Durable Drop Forged Steel
- Specialized Jaw will Securely Grip Cooling System, Fuel and Vacuum Lines without Damaging the Hose
- Heavy Duty Double-Dipped Synthetic Grip Handles to Minimize Slippage and Reduce User Fatigue
- Chrome Plated to Resist Rust

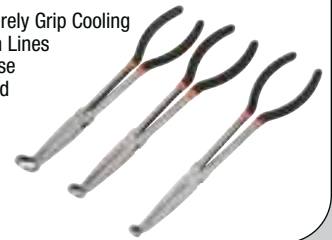

## Mechanic's Pliers

- Precision-Machined Jaws Provide Improved Grip
- TecReady Grip Handles Reduce User Fatigue
- Nickel Chrome Plated to Resist Rust



### Diagonal Pliers

- High Leverage Design for Gripping, Bending and Cutting Tasks



### Linesman Pliers

- Designed for Gripping, Twisting, Bending and Cutting Wire and Cable



### Groove Joint Pliers

- Adjustable Jaw Provides Gripping Power for Turning Irregularly Shaped Objects, Nuts and Bolts



### Long Nose Pliers with Side Cutter

- For Powerful Gripping and Cutting in Hard-to-Reach Spaces



SKU	Part #	Type	Size	Price
081241	22615	Diagonal	7-1/2"	<b>17.99</b>
081245	22617	Groove Joint	6"	<b>16.99</b>
081246	22618		8"	<b>18.99</b>
081247	22619		10"	<b>19.99</b>
081248	22620		12"	<b>21.99</b>
081252	22624		16"	<b>24.99</b>
081243	22616	Linesman	8"	<b>18.99</b>
081237	22612	Long Nose Pliers with Side Cutter	6"	<b>16.99</b>
081239	22613		8"	<b>18.99</b>

## X-Type Pliers



### 2 Piece 13" Long Nose Pliers Set

SKU 213127  
22632

- Includes: 45° and Straight Extended Reach Pliers



**29<sup>99</sup>**

REG. \$39.98

**SAVE OVER \$9**

When You Buy the Set

### 13" Long Nose Pliers

- Serrated Jaws for Precision Gripping

#### Straight

SKU 213135  
22633 **19<sup>99</sup>**

#### 45°

SKU 213117  
22634 **19<sup>99</sup>**

Prices subject to change without notice. Prices do not include applicable taxes, vehicles, tires, rims, installation or optional equipment as shown. Please do not return purchases to the store. For information regarding warranty, repair, or any questions or concerns, call 901-300-4878.

AZG0225

# HAND TOOLS

## Punch Set

OEM TOOLS

### 16 Piece Punch and Chisel Set

SKU 914624 25515 **29<sup>99</sup>** REG. \$34.99 **SAVE \$5**

- Includes: 5 Taper Punches, 5 Pin Punches, 2 Center Punches, 3 Cold Chisels and 1 Chisel Gauge

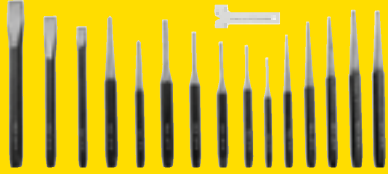

Offer Good Through June 30, 2025

## Dead Blow Hammers

### 3 Piece Dead Blow Hammer Set

SKU 900804 25517 **27<sup>99</sup>** REG. \$32.99 **SAVE \$5**

- Soft Rubber Handles for Non-Slip Grip
- Steel Shot Filled for More Force
- Non-Spark Material Used

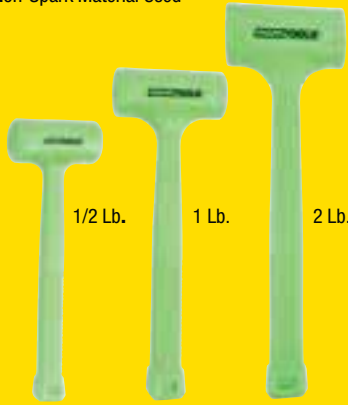

Offer Good Through June 30, 2025

## Pry Bars

OEM TOOLS

### 3 Piece Light Duty Smoothing/Prying Kit

SKU 004111 25084 **22<sup>99</sup>**

- Pry Dashboard Parts and Vents without Damaging Interior
- Clean Crevices and Joints in Small Electronics
- Disassemble Key Fobs and Other Remotes
- Evenly Smooth Epoxy and Adhesives

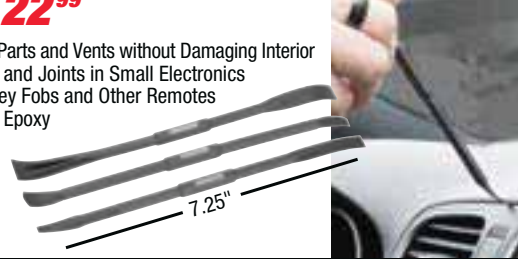

## 3 Piece Pry Bar Set

SKU 626114 24433 **39<sup>99</sup>**

- Lengths Included: 12", 18" and 24"
- 3 Sided Handle for Secure Grip and Comfort
- Solvent Resistant and Easy to Clean



## 36" Pry Bar

SKU 695126 24435 **35<sup>99</sup>**

- Unique Ergonomically Designed 3-Sided Handle for Secure Grip and Comfort
- Handles Made with Hardened Resin That is Solvent Resistant and Easy-to-Clean
- Forged and Hardened 5/8 In. Square Stock for Incredible Strength



OEM TOOLS

## Adjustable Wrenches

OEM TOOLS

- Made with Special Alloy Steel, Heat-Treated
- Deep Marking for Easy Identification
- Nickel Chrome Plated Steel Won't Rust
- Flat Profile is Comfortable in Hands



SKU	Part #	Size	Price
081268	22650	4"	<b>9.99</b>
081269	22651	6"	<b>11.99</b>
081271	22652	8"	<b>13.99</b>
081273	22653	10"	<b>15.99</b>
081274	22654	12"	<b>17.99</b>
081297	22655	15"	<b>21.99</b>

## Pipe Wrench

GreatNeck

- Precision Milled Moveable Jaws
- Perfectly Balanced



APW24

SKU	Part #	Material	Size	Price
965845	APW14	Aluminum	14"	<b>29.99</b>
965848	APW18		18"	<b>59.99</b>
972768	APW24		24"	<b>59.99</b>
965847	APW36		36"	<b>69.99</b>
965846	PW24	Steel	24"	<b>44.99</b>

## Pick-Up Tool

OEM TOOLS

### Heavy Duty Telescopic Magnetic Pick-Up Tool

SKU 231205 25466 **16<sup>99</sup>**

- Lifts Up to 3 Lb.
- Telescoping Handle Range: 6" to 33"



## Cutting Tools

### Folding Lock Back® Utility Knife with Blade Dispenser

SKU 1022296 25537 **14<sup>99</sup>**

- Includes: Blade Dispenser with 50 Blades
- Extra-Wide Handle for Increased Comfort and Leverage



OEM TOOLS

### Premium Folding Lock Back® Utility Knife with Sheath

SKU 1142419 12818 **19<sup>99</sup>**

- 3-1/2" Stainless Steel and Hardwood Handle
- Patented Quick-Change Mechanism
- Accepts All Standard Utility Blades
- Includes: 1 Blade and Leather Sheath with Pocket Clip



SHEFFIELD

### 4 Piece Plastic Scraper Set

SKU 900802 25513 **19<sup>99</sup>**

- Works Like a Chisel
- Will Not Scratch Paint
- Will Not Cause Sparks
- Can Be Used for Wheel Weight Removal

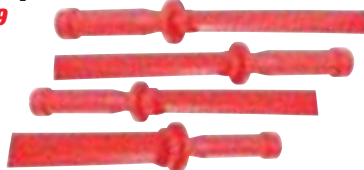

OEM TOOLS

### 10" Utility Scissors

SKU 1142911 25085 **15<sup>99</sup>**

- Super Hard Diamond-Like Carbon (DLC) Coating
- Stainless Steel Construction for Strength and Durability
- Bolt Lock Keeps Blades Secure
- Full Length Metal Frame Extends Through Handle for Added Strength



OEM TOOLS

### Scraper Kit

SKU 1282744 69004 **19<sup>99</sup>** REG. \$38.97 **SAVE OVER \$18** When You Buy the Kit

- Includes: 2 Packs of Razor Blades (200) and 1 Razor Blade Scraper
- Perfect for Removing Paint and Decals



OEM TOOLS

### Moab Auto Emergency Folding Pocket Knife

SKU 1142700 12870 **24<sup>99</sup>**

- 3-5/16" Partially Serrated Stainless Steel Blade, 4-1/2" Folded
- One-Handed Opening Mechanism
- Liner Lock
- Glass Breaker
- Belt Cutter
- Pocket Clip
- 4.5 Oz.
- Lifetime Warranty



SHEFFIELD

# HAND TOOLS

TO ORDER, contact your Commercial Sales Manager or go to [AutoZonePro.com](http://AutoZonePro.com)

HAND TOOLS

## Precision Drivers

- Precision Driver Sets for Electronics and Applications in Tight Spaces
- Magnetic Tips to Secure Fasteners
- Constructed with Durable Chrome Vanadium Steel

### 7 Piece Metric Nut Driver Set

SKU 1282732 **24<sup>99</sup>** REG. \$29.99

- Includes: 3.0, 3.5, 4.0, 4.5, 5, 5.5 and 6.0 mm

### 7 Piece Metric Hex Driver Set

SKU 1282731 **24<sup>99</sup>** REG. \$29.99

- Includes: 0.7, 0.9, 1.3, 1.5, 2.0, 2.5 and 3.0 mm

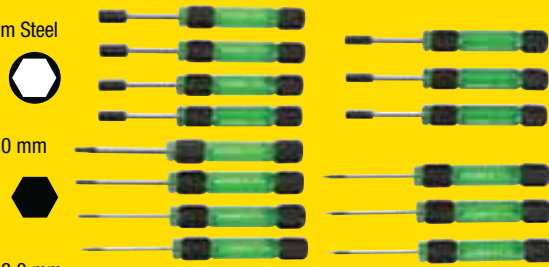

SAVE \$5



## 6 Piece Precision Screwdriver Set

- Constructed with Durable Chrome Vanadium Steel

### Star Screwdriver Set

SKU 003763 **12<sup>99</sup>** 22559

- Set Includes: T5, T6, T7, T8, T9 and T10

### Screwdriver Set

SKU 003751 **12<sup>99</sup>** 22560

- Slotted Screwdrivers: (1.4, 2, 2.4 and 3 mm)
- Phillips Screwdrivers: (#0 and #1)



Magnetic Tips to Secure Fasteners

OEM TOOLS

## Picks

### 4 Piece 14" Jumbo Pick Set

SKU 094658 **29<sup>99</sup>** REG. \$34.99

- Includes: Straight, 90°, Offset and Hook Pick

SAVE \$5



Offer Good Through June 30, 2025

## 8 Piece Combination Hook and Pick Set

SKU 1168660 **19<sup>99</sup>** 68913

- Set Includes: 4 Pc. 8" Hook and Pick Set with Acetate Handle and 4 Pc. 6" Mini Hook and Pick Set with Cushion Grip



## 6 Piece 8" Hook and Pick Set

SKU 1207883 **16<sup>99</sup>** 26545

- Set Includes: 1 Hook Pick, 1 Complex Pick, (1) 90° Pick, 1 Combination Pick, 1 Double Angle Pick, 1 Straight Pick



## 8 Piece 10" Cushion Hook and Pick Set

SKU 1207881 **14<sup>99</sup>** 26526

- Set Includes: Hook Pick, 90° Pick, 45° Pick, Double Angle Pick, Complex Pick, Angle Hook Pick, Combination Pick and a Straight Pick

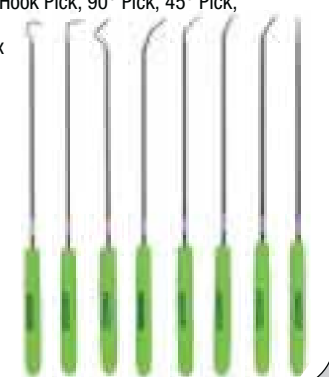

OEM TOOLS

## Safety Wire Pliers

OEM TOOLS

### Reversible Wire Twister Pliers

- Includes: 10 Meter x 0.5 mm Wire
- Heavy Duty Construction with Automatic Spring Return
- Reversible Action for Left and Right Twists
- Locking Jaws for Superior Wire Twisting
- Forged High Carbon Diamond Grooved Jaws to Cut and Grip Stainless Wire

9" SKU 1362002 **69<sup>99</sup>** 22662

6" SKU 1282736 **49<sup>99</sup>** REG. \$59.99 22661

SAVE \$10

6" and 9" SKU 1282746 **99<sup>99</sup>** 22663

Offer Good Through June 30, 2025



## Hack Saw and Blade Packs

### Professional Hack Saw

SKU 1142352 **11<sup>99</sup>** 74007

- Includes (1) 12" 24 TPI Bi-Material Blade
- High Tension Blade Prevents Twisting to Ensure Straight, Fast Cut
- Ergonomic Comfort Grip on Front Frame and Handle Provides Two-Handed Control



GreatNeck



Tension Control Provides Easy Adjustment When Changing Blades

## Bolt Cutters

OEM TOOLS

### 8" Mini Bolt Cutter

SKU 479080 **27<sup>99</sup>** 22609

- Designed for Heavy Duty Wire, Bolt, Nail and Rivet Cutting
- 8" Mini Bolt Cutter Features Induction Hardened Cutting
- Blades Rated at Over 58 HRC



### Bolt Cutters

- Forged S2 Steel Construction for Cutting Power
- Hardened Cutting Edge for Long Life
- Ergonomic Comfort Grip Handles
- Limited Lifetime Warranty

GreatNeck



24" SKU 025213 **29<sup>99</sup>** BC24

30" SKU 965828 **49<sup>99</sup>** BC30

36" SKU 965827 **59<sup>99</sup>** BC36

## Specialty Wrenches

OEM TOOLS

### Adjustable Gland Nut Wrench

- For Hydraulic Cylinders with Gland Nuts
- Reversible Design

SKU 1207900 **26<sup>99</sup>** 27398

- Range: 1" to 3.75"
- Pin Size: 7/32" and 1/4"
- Drive: 1/2"



SKU 1340231 **34<sup>99</sup>** 27397

- Range: 2" to 6"
- Pin Size: 1/4" and 5/16"
- Drive: 3/4"



## Nut Drivers

### 7 Piece Professional Nut Driver Set

- Chrome Vanadium Steel for Strength and Durability
- Highest Quality Acetate Handle Stands Up to Abuse
- Color Coded for Easy Identification

Metric SKU 949001 **22<sup>99</sup>** ND71

- Sizes: 6, 7, 8, 9, 10, 11 and 12 mm

SAE SKU 949002 **22<sup>99</sup>** ND72

- Sizes: 3/16", 1/4", 5/16", 11/32", 3/8", 7/16" and 1/2"



GreatNeck

Prices subject to change without notice. Prices do not include applicable taxes, vehicles, tires, rims, installation or optional equipment as shown. Please do not return purchases to the store. For information regarding warranty, repair, or any questions or concerns, call 901-300-4878.

# THREAD REPAIR

## Ford Triton Repair Kits

### Ford Triton 2 Valve Cylinder Repair Set

SKU 1268421 **369<sup>99</sup>**  
CAL38900

- Quality Foolproof Repair System That is Cost-Effective and Fast
- High-Quality Oversized Steel Alloy Insert Will Repair Other Inserts That Fail
- Application: 1996 to 2003 Ford 4.6L, 5.4L and 6.8L Engines



### Ford 2 Valve Insert

SKU 1268420 **34<sup>99</sup>**  
CAL389-100

- Designed to Aid in Repairing 1996-2003 Two Valve Ford Modular Cylinder Heads
- High Quality Oversized Steel Alloy Insert Will Repair Other Inserts That Fail

### Ford Triton 3 Valve Set

SKU 343388 **329<sup>99</sup>**  
CAL39300

- Application: 2004 to 2008 Ford 4.6 and 5.4 3 Valve Engines with Spark Plugs That are M16 x 1.5
- Includes 8 Inserts



### M16 x 1.5 3 Valve Insert

SKU 396658 **24<sup>99</sup>**  
CAL393-100

- Note: this is NOT the Replacement Insert for the Triton 2 Valve Kit



### Ford Triton Spark Plug and Electrode Repair Set

SKU 1268418 **99<sup>99</sup>**  
CAL39500

- Extracts the Broken Porcelain or Seized Sleeves from Broken Spark Plugs in 2003 to Current Ford Triton Engines



### Ford Triton Plug-Saver® Kit

SKU 094873 **124<sup>99</sup>**  
FIX98140T

- Designed to Specifically Repair the Spark Plug Ports in 4.6, 5.4 and 6.8 Ford Triton Engines
- Repairs Worn, Damaged Threads
- Includes: Self Cutting Tap, Tool and 8 Inserts in a Sturdy Case



### Inserts (Pack of 8)

SKU 110263 **39<sup>99</sup>**  
FIX98149P

### Broken Spark Plug Remover Ford Triton 3 Valve

SKU 489173 **129<sup>99</sup>**  
LIS65600

- Includes a Unique Porcelain Pusher Tool and a Tapered Left-Hand Thread Remover for Removing the Broken Spark Plug without Leaving the Porcelain in the Engine Cylinder



## Oxygen Sensor Thread Repair

### Oxygen Sensor Thread Repair Kit

SKU 010134 **134<sup>99</sup>**  
FIX38189-1

- No Need to Replace Exhaust Manifold
- Pilot Nose Tap Provided



## Wheel Stud Cleaner

### Quick Change Wheel Stud Cleaner Kit

SKU 666299 **69<sup>99</sup>**  
CAL16

- Includes: 1/2" Drive Adapter and 6 Brushes
- Brush Sizes: 7/16" (12 mm), 1/2" (13 mm), 9/16" (14 mm), 5/8" (16 mm), 7/8" (22 mm) and 1-1/8" (28 mm)



## Head Bolt Thread Repair

### Metric Head Bolt Thread Repair Kit

SKU 010131 **149<sup>99</sup>**  
FIX35119S

- Extended Reach for Deep Threads
- Longer Length (33 x 1.5 mm) Inserts for Maximum Thread Engagement
- Applications: Cadillac, Honda, Toyota and Other Imports That Use M11 x 1.5 Head Bolts



## Spark Plug Thread Repair

### Spark Plug Thread Repair Kit - Metric M14 - 1.25

SKU 557108 **34<sup>99</sup>**  
25643

- Includes: High-Grade Tap, (3) Inserts and a Job-Specific Installation/Tang Break-Off Tool
- Returns Threads to Original Size
- Creates a Permanent and Wear-Resistant Thread



## Nut Busting Bolt Extractors

### Nut Busting Bolt Extractor Socket Sets

- High Visibility Markings for Fast, Easy Socket Selection
- Chrome-Molybdenum Steel Construction for Maximum Durability
- 3/8" Drive

Specialized Design for a Secure Universal Grip



### 9 Piece (Metric)

SKU 751718 **24<sup>99</sup>**  
22967

- Includes: 8 mm, 10 mm, 11 mm, 12 mm, 13 mm, 14 mm, 16 mm, 17 mm and 19 mm



### 9 Piece (SAE)

SKU 751720 **24<sup>99</sup>**  
22968

- Includes: 1/4", 5/16", 3/8", 7/16", 1/2", 9/16", 5/8", 11/16" and 3/4"



# THREAD REPAIR

TO ORDER, contact your Commercial Sales Manager or go to [AutoZonePro.com](http://AutoZonePro.com)

THREAD REPAIR

## Spiral Bolt Extractor Sets

- Made of High-Quality Chrome Molybdenum Steel for Durability
- Grips and Removes a Wide Range of Stubborn Fasteners
- 3/8" Drive

**Bites into Rusted, Rounded and Painted Over Nuts and Bolts**



Impact Drill Not Included

OEM TOOLS



Specialized Spiral Design for a Secure Universal Grip on Nuts and Bolts

### 3/8" Drive 18 Piece Impact Extractor Set

SKU 1361992 **49<sup>99</sup>**  
23700

- Sizes: 7 mm, 5/16" (8 mm), 9 mm, 3/8", 10 mm, 7/16" (11 mm), 12 mm, 1/2", 3 mm, 14 mm, 9/16", 5/8" (16 mm), 17 mm, 11/16", 3/4" (19 mm) and 1/4" Hex Adapter and Knockout Pin

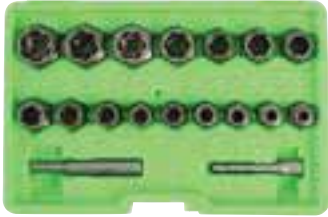

### 5 Piece Spiral Type Deep Extractor Set on Aluminum Rail

SKU OUTSIDE BUY/EPO **38<sup>99</sup>**  
22993

- Sizes: 3/8" (10 mm), 7/16" (11 mm), 1/2" (13 mm), 9/16" (14 mm) and 5/8" (16 mm)



For Outside Buy/EPO, Call 901-300-4878

### 5 Piece Spiral Type Extractor Set on Aluminum Rail

SKU 081304 **31<sup>99</sup>**  
22985

- Sizes: 5/16" (8 mm), 10 mm, 13 mm, 11/16" and 3/4" (19 mm)



### 10 Piece Spiral Type Bolt Extractor Set on Aluminum Rail

SKU 081788 **39<sup>99</sup>** **SAVE \$10**  
22988 REG. \$49.99

- Sizes: 5/16" (8 mm), 3/8", 10 mm, 7/16" (11 mm), 13 mm, 11/16", 1/2" (13 mm), 9/16" (14 mm), 3/4" (19 mm) and 5/8" (16 mm)



Offer Good Through June 30, 2025

## Drain Plug Repair

CAL

### Drain Plug Repair Kit

SKU 818569 **99<sup>99</sup>**  
CAL38400

- Designed to Repair Aluminum Oil Pans with Damaged Drain Plug Threads, Size M12 x 1.75 Commonly Found in GM, Ford and Mazda Vehicles
- Includes: Drill, Counter Bore, Tap, Driver, Guide and (5) 12 mm Inserts
- Allows Use of OEM Plug Instead of an Oversize Replacement



### Oil Pan Rethreading Kit

SKU 751709 **149<sup>99</sup>**  
LIS58850

- Oil Pan Plug Rethreading Kit Works on Steel or Aluminum Pans 1/2", 12 mm and 14 mm Threads



Lisle

## Axle Spindle Thread Repair

### Axle Spindle Threading Set

SKU 1103645 **49<sup>99</sup>**  
37233

- Used to Clean or Repair Axle Threads
- Set Comes with a Special Twist Shape That Provides Easier and Quicker Work
- Sizes Included: M20 x 1.25, M20 x 1.50, M22 x 1.00, M22 x 1.50, M24 x 1.50, M24 x 2.00, 13/16" x 20 UNEF, 3/4" x 20 UNEF and 27 mm Extension Bar



OEM TOOLS

## Tap Sockets

### 8 Piece Tap Socket Set

SKU OUTSIDE BUY/EPO **39<sup>99</sup>**  
24750

- Designed to Fit All Standard Taps Up to 1/2"
- Compatible with 1/8" NPT Taps and Metric Taps Up to 12 mm
- Perfect for Use in Tight Spaces Where a T-Handle Cannot Fit



OEM TOOLS

For Outside Buy/EPO, Call 901-300-4878

## Screw Extractor Bits

### 6 Piece Spiral Flute Screw Extractors Set

SKU 099277 **14<sup>99</sup>**  
24374

- Extractors: Ex-1, Ex-2, Ex-3, Ex-4 and Ex-5
- Left Hand 135° Split Point Cobalt
- Drill Bit Sizes: 5/64", 7/64", 5/32", 1/4" and 19/64"
- Pilot Point Starts on Contact and Eliminates Bit Walking
- Comes in a Vinyl Pouch



### 10 Piece Spiral Extractor and Drill Bit Combo Pack

SKU 099229 **19<sup>99</sup>**  
24373

- Extractors: Ex-1, Ex-2, Ex-3, Ex-4 and Ex-5
- Left Hand 135° Split Point Cobalt
- Drill Bit Sizes: 5/64", 7/64", 5/32", 1/4" and 19/64"
- Pilot Point Starts on Contact and Eliminates Bit Walking
- Comes in a Vinyl Pouch



### 10 Piece Multi-Spline Screw Extractor Set

SKU 099281 **24<sup>99</sup>**  
24375

- Sizes 1/8" to 13/32" (1/32" Increments)
- Can Be Used with Hand Sockets and Wrenches
- Aggressive Left Hand Spiral Design Provides Extra Gripping Power
- Designed to Prevent Extractor from Entering too Deeply and Expanding Screw
- Comes in a Foam-Lined Metal Case



### 35 Piece Master Screw Extractor/Drill Bit Set

SKU 099258 **89<sup>99</sup>** **SAVE \$10**  
24377 Reg. \$99.99

- Spiral and Multi-Spline Extractors for Removing the Toughest Bolts and Screws from 3/32" to 15/16"
- 135° Split Point Left Hand Cobalt Drill Bits
- Comes in a Foam-Lined Metal Case



Offer Good Through June 30, 2025

### 4 Piece Damaged Screw Extractor Set

SKU 081310 **9<sup>99</sup>**  
25158

- Used to Quickly Remove Stripped, Broken and Painted Over Screws
- Will Work with Phillips, Flathead, Hex and Other Common Screws



OEM TOOLS

Prices subject to change without notice. Prices do not include applicable taxes, vehicles, tires, rims, installation or optional equipment as shown. Please do not return purchases to the store. For information regarding warranty, repair, or any questions or concerns, call 901-300-4878.

# SHOP SUPPLIES

## SNG Consumables

### Start-Up Kit (Dispenser and Product)

SKU 262544  
SNGMFKP994376

**599<sup>99</sup>**

- Kit Includes:  
250 Seat Covers  
250 Paper Floor Mats  
500 Plastic Floor Mats  
500 Parts Bags  
100 Tire Bags  
1 Metal Floor Rack  
1 Sign



**BONUS VALUE: \$64.99**

### Steering Wheel Cover (500/Box)

SKU SNGFBP994462

With Purchase of:  
SNGMFKP994376

Offer Good While  
Supplies Last Through  
June 30, 2025



### Plastic Write On Key Tag (1,000 Count)

- Self Locking Plastic Key Tags Help Secure Keys

**29<sup>99</sup>**

#### White

SKU 262547  
SNGMFBP993323

#### Yellow

SKU 1125859  
SNGFBP993324

#### Blue

SKU 1125872  
SNGFBP993398

#### Red

SKU 1125868  
SNGFBP993399

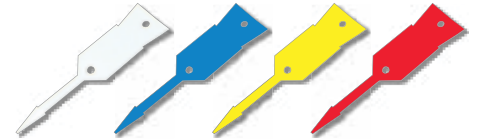

### Disposable Seat Cover

- 2-Layer Construction Keeps Cover in Place
- Refill for Start-Up Kit

#### Premium (250/Roll)

SKU 262537  
SNGMFGP994314

**119<sup>99</sup>**

- .7 Mil Thick with the Dimensions of 32" x 56" Dispensing Box

#### Value (500/Roll)

SKU 186487  
SNGMFGP994315

**129<sup>99</sup>**

- .5 Mil Thick with the Dimensions of 32" x 52"

### Plastic Floor Mats (500/Box)

SKU 186488  
SNGMFGP994302

**74<sup>99</sup>**

- Roll Size: 16.5" x 21"
- Comes in Durable Self-Dispensing Box



### Steering Wheel Cover (500/Box)

SKU 186485  
SNGMFBP994333

**74<sup>99</sup>**

- Double-Band Design Ensures a Snug Fit and Easy Installation



Vehicle Not Included

### Work Ticket Holder (25/Box)

- Durable Brass Grommet Increases Strength
- Accommodates Most Pre-Printed and Computer Generated Forms

#### Clear

SKU 698887  
SNGFBP993302

**59<sup>99</sup>**

- 10.5" x 14.5" Clear Front and Back

#### Clear/Black

SKU 1142449  
SNGFBP993303

**59<sup>99</sup>**

- 11" x 13" Clear Front and Black Back



### Adhesive Floor Mats (175/Roll)

SKU 262546  
SNGMFBP993349

**119<sup>99</sup>**

- Self Adhesive, 3 mil Protective Film Keeps Carpet Protected



### Parts Bag 11" x 17" (500/Case)

SKU 262541  
SNGMFGP994330

**49<sup>99</sup>**

- High Strength Protection
- Impervious to Most Shop Chemicals

Price Does Not Include Parts Shown



## Paper Floor Mat



### Paper Floor Mat (500/Box)

SKU OUTSIDE BUY/EPO  
DOWPFM-500

**59<sup>99</sup>**

- Durable Paper
- Measures 16" x 22"

**NEW**

For Outside Buy/EPO, Call 901-300-4878



## Oil Change Labels

### Thermal Oil Change Sticker Printer

SKU OUTSIDE BUY/EPO  
SNGFKGX00106

**719<sup>99</sup>**

- Kit Includes: Printer, Keyboard, Power Cord/Adapter, 1 Ink Ribbon and 2 Rolls of 500 Generic Static Cling Labels



### Static Cling Refill Kit

SKU 291380  
SNGMFKG016501

**139<sup>99</sup>**

- 2 Rolls of Labels
- 1 Replacement Ribbon
- Fits Thermal Oil and Static Cling Printers

For Outside Buy/EPO, Call 901-300-4878

### Red Oil Can Service Reminder Labels

SKU 1405960  
SNGFB-P993345

**39<sup>99</sup>**

- Replacement Roll of 500 Labels



### Blue Wrench Service Reminder Labels

SKU 1407511  
SNGFB-P993394

**39<sup>99</sup>**

- Replacement Roll of 500 Labels



## Hand Cleaner

### Starter Kit with Dispenser

SKU 972773  
24292



**64<sup>99</sup>**

- Kit Includes: Wall-Mount Dispenser and 4,000 mL of Cherry Fragrance Cleaner
- All Natural, Concentrated, Solvent Free Cleansing Formula
- Unique Skin Conditioning System Leaves Hands Feeling Smoother, While Fibril Scrubbers Deep Clean Even the Toughest Dirt
- 100% Biodegradable

### 4000 mL Refill Bottle

SKU 972772  
24291

**44<sup>99</sup>**



## Tumbler



### 20 Oz. Stainless Steel Double Wall Tumbler

SKU 1392320  
26046

**14<sup>99</sup>**

- Keeps Drinks Cold for 24 Hours and Hot for 6 Hours
- Lid Made from Durable BPA-Free Plastic



Prices subject to change without notice. Prices do not include applicable taxes, vehicles, tires, rims, installation or optional equipment as shown. Please do not return purchases to the store. For information regarding warranty, repair, or any questions or concerns, call 901-300-4878.

## Creepers Seats

### Workshop Seat and Step Stool

SKU 1189077  
24904

**69<sup>99</sup>** REG. \$89.99

**SAVE \$20**

- Combination Step Stool and Creeper Seat That Allows Additional Maneuverability
- Thick Padding Covered with Durable Vinyl Provides Comfort While Working
- Includes a Tool Tray for Organization and Convenience
- 4 Swivel Casters Made for All Terrain
- Weight Capacity: 300 Lb.
- 18"(L) x 16"(W) x 7"(H)



Offer Good Through June 30, 2025

### Sidekick Creeper Stool

SKU 1168662  
24987

**124<sup>99</sup>**

- Large Open Tray to Carry a Wide Range of Items with Additional Holster Caddies on the Side for Rapid Access to Most Used Items
- Slide Out Under Seat Drawer Can Be Used to Store and Organize Tools
- Weight Capacity: 330 Lb.



### Heavy Duty Rolling Workbench and Creeper Seat

SKU 1142423  
24986

**89<sup>99</sup>**

- Molded Seat and Frame Provide Durable Support
- Removable Clip-In Trays for Storage and Easy Transport of Parts and Tools
- Trays Feature Screwdriver Storage Holes for Easy Organization
- Weight Capacity: 300 Lb.



### Cushioned Creeper Seat with Tool Tray

SKU 757019  
24948

**49<sup>99</sup>**

- Tool Tray Dimensions: 11-1/2" x 12-1/2"
- Cushioned Seat
- 4 Swivel, Oil-Resistant Wheels
- Weight Capacity: 330 Lb.



## Creepers

### Mechanics Creepers with Headrest

- Made with HDPE Plastic and Molded for Comfort to Ensure a Quick and Accurate Job
- Easy to Handle, Lift and Store
- 6 Swivel Casters Able to Maneuver All Terrain
- Casters are 3" in Diameter for Additional Durability and Product Longevity
- Weight Capacity: 350 Lb.

40"  
SKU 1189063  
24909

**SAVE \$10**

**44<sup>99</sup>** REG. \$54.99

- Light Weight 13.2 Lb.
- 40"(L) x 19"(W)

36"  
SKU 1189084  
24977

**SAVE \$10**

**39<sup>99</sup>** REG. \$49.99

- Light Weight 9 Lb.
- 36"(L) x 18"(W)



### Professional 41" 6 Wheel Creeper

SKU 125749  
24970

**109<sup>99</sup>**

- 3D Streamline Design for Shoulder Clearance
- 6 Heavy Duty TPU Casters
- Low Ground Clearance Allows for Greater Mobility
- 4 Tool Storage Trays
- Weight Capacity: 300 Lb.



## Topside Creepers

### Topside Creeper

SKU OUTSIDE BUY/EPO  
TRX3-100

**379<sup>99</sup>**

- Height Adjusts from 48" to 64"
- Weight Capacity: 400 Lb.

### NXT Topside Creeper

SKU OUTSIDE BUY/EPO  
TRX3-200

**499<sup>99</sup>**

- Height Adjusts from 48" to 64"
- I-Base Design for More Flexible Positioning Around the Vehicle
- Weight Capacity: 400 Lb.



TRX3-200

For Outside Buy/EPO,  
Call 901-300-4878

**TRAXION**  
engineered products

## Work Stand

### Pro Step Adjustable Work Stand

SKU 222856  
STK20350

**249<sup>99</sup>**

- 500 Lb. Capacity
- Height Adjustable from 6-1/2" to 22-1/2"
- 32" x 16"



**STECK**  
engineered products

# SHOP SUPPLIES

## Workshop Stools

### Swivel Shop Stools

- Swivel Seat
- Double Foot Ring for Strength
- Seamless Pad
- 30.5" High x 14" Across

**Black**  
SKU 512951  
24910

**79<sup>99</sup>**



**Black (2 Pack)**  
SKU 432326  
24910TWO

**149<sup>99</sup>**

### Adjustable Height Stool

- Ideal for Shop or Garage Use
- Adjustable Height: 28" to 32-1/2"
- Durable, Vinyl-Padded Swivel Seat
- Backrest for Comfortable Support

**Black**  
SKU 512945  
24911

**99<sup>99</sup>**

**Black (2 Pack)**  
SKU 362969  
24911TWO

**149<sup>99</sup>**



**Green (2 Pack)**  
SKU 758787  
24931TWO

**149<sup>99</sup>**

### Adjustable Hydraulic Shop Stool

SKU 751712  
24912

**149<sup>99</sup>** **NEW**

- Vinyl Padded Swivel Seat for Comfort
- Chrome Footrest
- Powder Coated Legs

Adjustable Height:  
28" to 32-1/2"

Leg Color May Vary



OEM TOOLS<sup>®</sup>



300 Lb. Weight Capacity



360° Rotating Seat

## Fender Covers

### Fender Cover

SKU 965832  
24900

**14<sup>99</sup>**

- Heavy Gauge Vinyl Wipes Clean
- 27" x 34"



### Soft Fleece Fender Cover

SKU 751711  
24899

**25<sup>99</sup>**

- Soft Fleece Fender Cover to Prevent Paint Damage
- 2 Super Powerful Corner Magnets for Securing the Cover in Place
- Magnets are Removable to Wash the Cover
- Large 42" x 24" Size for Cars, Trucks and SUVs



OEM TOOLS<sup>®</sup>

## Magnetic Nut Cups

### Multicolor Magnetic Nut Cup Assortment (4 Pack)

SKU 1282743  
68939

**29<sup>99</sup>**

- Holds Bolts, Nuts and Parts to Speed Up Work and Eliminate Misplacing Parts
- Coated Magnet Sticks to All Ferrous Metal Work Surfaces
- Includes: 1 Green Cup, 1 Red Cup, 1 Orange Cup, 1 Blue Cup

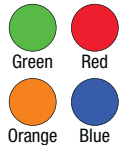

Hang Hole

Strong Magnets Attach the Cups Securely to Most Flat Metal Surfaces

OEM TOOLS<sup>®</sup>

# GM GEARWRENCH

## DIAGNOSTICS THAT BREAK ALL THE RULES

SHOP DIAGNOSTICS AT AUTOZONEPRO.COM

Delivering more for techs, just like always. No more missing functionality. No more expensive subscriptions. No more overpriced hardware. We're delivering a combination of power and value that other tool brands can't touch.



**\$69<sup>99</sup>**

GWSCAN, SKU: 1480740  
EVERYDAY DIAGNOSTIC  
SCAN TOOL



**\$149<sup>99</sup>**

GWSMARTBT, SKU: 1480738  
PROFESSIONAL BIDIRECTIONAL  
DIAGNOSTIC TOOL



**\$699<sup>99</sup>**

GWSMART07, SKU: 1480739  
7" WIRELESS BIDIRECTIONAL  
DIAGNOSTIC TABLET



**Hardware and Service Parts** **HARDWARE MACHINERY**

**96 Piece Mini Fuse Kit**  
 SKU 271169 **19<sup>99</sup>**  
 68148

- Includes: Mini Fuses 3A to 30A

**96 Piece ATO Fuse Assortment** **HARDWARE MACHINERY**  
 SKU 271172 **8<sup>99</sup>**  
 68149

- Includes: ATO Fuses 3A to 30A

**24 Piece Maxi Fuse Assortment** **HARDWARE MACHINERY**  
 SKU 271152 **24<sup>99</sup>**  
 68146

- Includes: Maxi Fuses 20A to 100A

**200 Piece Spring Assortment** **HARDWARE MACHINERY**  
 SKU 271195 **14<sup>99</sup>**  
 68140

- Includes: 20 Popular Sizes from 7/32" x 11/16" to 5/16" x 1-1/4"

**Universal O-Ring Set** **HARDWARE MACHINERY**

**407 Piece (SAE)** SKU 546661 68168 **19<sup>99</sup>**

**419 Piece (Metric)** SKU 546659 68167 **19<sup>99</sup>**

- Inside Diameters from 1/8" to 2"
- Inside Diameters from 3 mm to 50 mm

**270 Piece A/C O-Ring Kit** **HARDWARE MACHINERY**  
 SKU 271196 **17<sup>99</sup>**  
 68141

- Contains 270 O-Rings in a Variety of SAE Sizes
- Great O-Ring Set for Most Automotive and Refrigerant Applications

**110 Piece Copper Washer Assortment** **HARDWARE MACHINERY**  
 SKU 271176 **17<sup>99</sup>**  
 68117

- Includes: Popular Sizes M6 to M16

**115 Piece Master Brake Line Fitting Assortment Kit** **Dynamic**  
 SKU 082943 **119<sup>99</sup>**  
 DOWDY-BLF-5

- 23 Brake Line Fitting Variations
- Tube Nuts, Union, Brake Line Adapters

**555 Piece Stainless Cotter Pin Assortment** **HARDWARE MACHINERY**  
 SKU 271183 **17<sup>99</sup>**  
 68121

- Includes: 6 Popular Sizes from 1/16" x 1" to 5/32" x 2-1/2"

**500 Piece Aluminum Rivet Assortment** **HARDWARE MACHINERY**  
 SKU 271150 **13<sup>99</sup>**  
 68109

- Includes: 1/8" and 3/16" Rivets 1/4", 5/16" and 3/8" Long

**80 Piece Vacuum Cap Assortment** **HARDWARE MACHINERY**  
 SKU 271197 **12<sup>99</sup>**  
 68129

- Includes Sizes: 3/16" to 3/8"

**34 Piece Hose Clamp Assortment** **HARDWARE MACHINERY**  
 SKU 271201 **14<sup>99</sup>**  
 68137

- Includes Sizes: 5/8" to 1-1/4"

**88 Piece Drain Plug and Gasket Assortment Kit** **Dynamic**  
 SKU 617724 **89<sup>99</sup>**  
 DOWDY-DPA-6

- 18 Drain Plug Variations, 4 Gasket Variations
- Most Popular 12 mm and 14 mm Drain Plugs

**240 Piece Master Drain Plug Gasket Assortment Kit** **Dynamic**  
 SKU 606762 **114<sup>99</sup>**  
 DOWDY-DGK-240

- 24 Drain Plug Gasket Variations
- Aluminum, Copper, Crush, Fold-Over, Nylon, Rubber/Metal

**120 Piece Oil Drain Plug Gasket Assortment** **SURBER**  
 SKU 1400041 **34<sup>99</sup>**  
 SURDPG120

- Covers Most Domestic and Import Cars and Light Trucks
- 120 Total: 24 Variations (5 each), Incl. Copper, Metal Crush, Nylon, Fiber and Rubber/Metal

**76 Piece Oil Drain Plug Assortment** **SURBER**  
 SKU 662839 **89<sup>99</sup>**  
 SURDP454

- Includes: 76 Pieces with Corresponding Gaskets, 17 Direct Fit SKUs
- Includes: Labeled Case for Quick Identification and Organization
- Covers Most Domestic and Import Cars and Light Duty Trucks

**60 Piece Wheel Lug Nut Assortment A** **Dynamic**  
 • 12 Lug Nut Variations

**Assortment A**  
 SKU 082947 **84<sup>99</sup>**  
 DOWDY-WN-12

- Standard, Dome, Acorn Thread

**Assortment B** **Dynamic**  
 SKU 082948 **124<sup>99</sup>**  
 DOWDY-WN-12B

- Dome Acorn, Bulge, Flat-Capped, External Thread

# SAFETY & GLOVES

## First Aid Kits

Safeguard Employees and Jobsites Through Injury Preparation with Multi-Functional First Aid Kits

### First Aid Kits

- Wall Mountable Organized Durable Plastic Case
- Contains Essentials for Light Injuries and Wounds
- Meets ANSI/ISEA Z308.1-2021, Class A, Type I, II, III, or IV First Aid Kit

#### 25-Person First Aid Kit

SKU 1442584  
SAS6025-025 **69<sup>99</sup>**

#### 100-Person First Aid Kit

SKU 765585  
SAS6099-100 **119<sup>99</sup>**



SAS6025-25



SAS6099-100



## Safety Supplies



### Hi Vis Knit Beanie - Orange

SKU 687972  
SAS692-1711 **11<sup>99</sup>**

- One Size Fits All
- Comfortable and Warm
- 100% Knit Polyester
- ANSI/ISEA 107 Compliant
- Reflective Knit Stripe



### Hot Sleeve

SKU 291321  
LIS18700 **24<sup>99</sup>**

- Protects Arms from Burns While Working Around the Engine
- Made of Durable, Heat-Resistant Kevlar
- Double Wall Construction for Added Heat Protection



### Face Shield Clear

SKU 972271  
SAS5140 **24<sup>99</sup>**

- Impact-Resistant Polycarbonate Shield
- Curved Lens Design
- Ratcheting Headpiece
- Meets ANSI Z87.1-2015



## Ear Plugs



### Foam Ear Plugs

SKU 526953  
SAS6100 **44<sup>99</sup>**

- Noise Reduction Rating: 31
- 200 Individually Packaged Pairs
- Pre-Shaped Foam Earplugs



## Safety Glasses

### LED Safety Glasses

SKU 555987  
26039 **18<sup>99</sup>**

- High-Impact Resistant Lens Protects Eyes
- Flexible, Lightweight and Padded Frames
- Meets ANSI Z87.1
- Includes: (8) LR41 Batteries



### LED Safety Glasses (3 Pack)

SKU 592265  
26017PK3 **29<sup>99</sup>**

### NSX Turbo Safety Glasses

- High-Impact Polycarbonate Lens
- Safety Eyewear That Also Provides 99.9% UV Protection



#### Smoke

SKU 462983  
SAS5331PK **29<sup>99</sup>**

- Box of 12



#### Clear

SKU 301767  
SAS5330PK **29<sup>99</sup>**

- Box of 12



#### Amber

SKU 462984  
SAS5332PK **29<sup>99</sup>**

- Box of 12

- Scratch-Resistant Coating
- Single Lens Design
- Lightweight Wrap-Around Lens
- ANSI/ISEA Z87.1-2015 Compliant



## STORE STOCKED

### Advantage X300 Series Safety Glasses - Amber (12 Pack)

SKU 1149164  
JASS70711PK **19<sup>99</sup>** REG. \$34.99

- Lightweight, Comfortable and Affordable
- Lens Features an Anti-Scratch Hard Coating
- Made Using Virgin, Unitary Polycarbonate Lenses
- 99.9% UV Protection
- Ideal for Construction, Shop and General Eye Protection Applications



**SAVE \$15**



Offer Good Through June 30, 2025

## Multifocal Safety Reading Glasses



- Eye Protection and Multifocal Reading Glasses
- High Impact, Anti-Scratch Lenses Protect Your Eyes
- Fully Adjustable Temples for Comfort and Fit
- ANSI/ISEA Z87.1-2015 Compliant

**19<sup>99</sup>** each

**+1.5** SKU 752076 26023  
**+2.0** SKU 752077 26024  
**+2.5** SKU 752078 26025  
**+3.0** SKU 752086 26026



## Eyewash Stations

### Emergency 9 Gallon Eyewash Station Wall Mount Gravity Fed

SKU 912344  
SAS5134-00 **309<sup>99</sup>**

- Compliance - ANSI Z358.1-2014
- Portable Unit Measures 20.15" x 16.5" x 9.5"
- Includes: Mounting Bracket, Inspection Tag, Tamper Resistant Tie and Preservative

### Eyewash Concentrate Solution

SKU 1142715  
SAS5136-01 **14<sup>99</sup>**

- For Use with 9 Gallon Eyewash Station #SAS5134-00

### Bottle Eyewash Station

SKU 094904  
SAS5132 **89<sup>99</sup>**

- Includes: (2) 16 Oz. Eye Irrigate Solution Bottles
- Does Not Meet ANSI Z358.1

### 16 Oz. Eyewash Irrigate Refill

SKU 977588  
SAS5130 **24<sup>99</sup>**

- For Use with Eyewash Station SAS5132



## Detection Light



### UV Leak Detection Light and Glasses

SKU 213144  
24516 **19<sup>99</sup>**

- Compact UV Leak Detection Pen Light
- Yellow Lens Protective Glasses Enhance Visibility of Leaks
- Can Be Used with All Types of UV Leak Detection Dyes
- Includes: 2 AAA Batteries



2 AAA

# SAFETY & GLOVES

TO ORDER, contact your Commercial Sales Manager or go to [AutoZonePro.com](http://AutoZonePro.com)

SAFETY & GLOVES

## Raven Patriot Gloves



- 7 mil Powder-Free Exam Grade Nitrile
- Textured fingertips
- Latex-Free



Compression Fit Technology



Environmentally Responsible



Supply Chain Resilient



### Buy More, Save More

5 Boxes of 100 Each **114<sup>99</sup>** ~~23.00~~ per box

Medium	SKU	1525554   SAS66482-5PK
Large	SKU	1525556   SAS66483-5PK
XL	SKU	1525565   SAS66484-5PK
2XL	SKU	1525560   SAS66485-5PK

10 Boxes of 100 Each **219<sup>99</sup>** ~~22.00~~ per box

Medium	SKU	1522380   SAS66482CS
Large	SKU	1525553   SAS66483CS
XL	SKU	1525561   SAS66484CS
2XL	SKU	1525562   SAS66485CS

## Raven Gloves



- 7 mil Powder-Free Exam Grade Nitrile
- Ambidextrous Textured Grip
- Latex-Free

Find In Store, Right Now  
**19<sup>99</sup>** per box

Medium	SKU	435079   66517
Large	SKU	244622   66518
XL	SKU	244617   66519



STORE STOCKED

### Buy More, Save More

2 Boxes of 100 Each **41<sup>99</sup>** ~~21.00~~ per box

Medium	SKU	547964   SAS66517-2PK
Large	SKU	547965   SAS66518-2PK
XL	SKU	547966   SAS66519-2PK
2XL	SKU	547963   SAS66520-2PK

5 Boxes of 100 Each **99<sup>99</sup>** ~~20.00~~ per box

Medium	SKU	1189346   SAS66517-5PK
Large	SKU	1189328   SAS66518-5PK
XL	SKU	1189339   SAS66519-5PK
2XL	SKU	1442587   SAS66520-5PK

10 Boxes of 100 Each **189<sup>99</sup>** ~~19.00~~ per box

Medium	SKU	1190191   SAS66517CS
Large	SKU	265052   SAS66518CS
XL	SKU	265053   SAS66519CS
2XL	SKU	1330682   SAS66520CS

## Astro-Grip Gloves



- 7 mil Powder-Free Exam Grade Nitrile
- Embossed Cube Grip
- Latex-Free

Find In Store, Right Now  
**24<sup>99</sup>** per box

Medium	SKU	823166   66472
Large	SKU	823167   66473
XL	SKU	823168   66474



STORE STOCKED

### Buy More, Save More

2 Boxes of 100 Each **54<sup>99</sup>** ~~27.50~~ per box

Medium	SKU	1330679   SAS66472-2PK
Large	SKU	1330676   SAS66473-2PK
XL	SKU	1331500   SAS66474-2PK
2XL	SKU	1331496   SAS66475-2PK

5 Boxes of 100 Each **129<sup>99</sup>** ~~26.00~~ per box

Medium	SKU	1330686   SAS66472-5PK
Large	SKU	1331480   SAS66473-5PK
XL	SKU	1331488   SAS66474-5PK
2XL	SKU	1331487   SAS66475-5PK

10 Boxes of 100 Each **249<sup>99</sup>** ~~25.00~~ per box

Medium	SKU	1330697   SAS66472CS
Large	SKU	1331497   SAS66473CS
XL	SKU	1331489   SAS66474CS
2XL	SKU	1331494   SAS66475CS

## Derma-Tuff Gloves



**20% MORE GLOVES\***  
120/BOX

- Powder-Free Exam Grade Nitrile, 6 mil
- Textured for Enhanced Grip
- Outstanding Strength, Wear and Dexterity



2 Boxes of 120 Each **28<sup>99</sup>** ~~14.49~~ per box

Large	SKU	1189330   SAS66583-2PK
XL	SKU	1189352   SAS66584-2PK

5 Boxes of 120 Each **71<sup>99</sup>** ~~14.39~~ per box

Large	SKU	1189350   SAS66583-5PK
XL	SKU	1189331   SAS66584-5PK

10 Boxes of 120 Each **139<sup>99</sup>** ~~13.99~~ per box

Large	SKU	1189326   SAS66583CS
XL	SKU	1189347   SAS66584CS

Prices subject to change without notice. Prices do not include applicable taxes, vehicles, tires, rims, installation or optional equipment as shown. Please do not return purchases to the store. For information regarding warranty, repair, or any questions or concerns, call 901-300-4878.



**FREE SHIPPING**  
WITH MOST ORDERS  
SEE PAGE 2 FOR DETAILS

**2025**  
**APR-JUN**

Hablamos Español **Call 901-300-4878**

## GREAT FINANCING PROGRAMS\*

**UNISOURCE** 800-404-6792

**NEWLANE** 267-768-3228

**PEAC** 856-505-4450

### 1 LEASING COMPANIES

- Leases are handled by four companies
- Customer must:
  - Select equipment
  - Complete credit application
  - Receive approval from leasing company
- Once the transaction is approved and documents are signed by customer:
  - Customer invoice is funded by leasing company
  - Equipment order is placed

**UniSource Capital**  
Never give up...Never Surrender!

**NL** NEWLANE  
FINANCE  
Business Growth. Better Today.

**PEAC**  
SOLUTIONS

### 2 30-60-90

- AutoZone® credit account in existence for 6 months
- Satisfactory payment history with AutoZone®
- Updated account application with agreement section completed and signed
- No NSF checks within 6 months
- No credit holds within 6 months
- Established credit worthiness
- Minimum down payment = 35%
- Minimum 52 wks. sales = \$15 K
- Minimum equipment cost = \$1 K (sales tax included)

### 3 EXTENDED TERMS

- AutoZone® credit account in existence for 1 year
- Satisfactory payment history with AutoZone®
- Updated account application with agreement section completed and signed
- No NSF checks within 6 months
- Established credit worthiness
- Minimum down payment = 35%
- Minimum 52 wks. sales = \$25 K
- Minimum equipment cost by term:
  - 6 months \$3 K
  - 9 months \$6 K
  - 12 months \$8 K or greater (financial statement may be required)

\* Financing is provided by third parties who are not affiliates of AutoZone. All of the advertised loan programs, rates, terms and conditions are subject to change at any time without notice. An extra charge may be imposed at the end of the lease depending on the residual value of the leased goods. Free overnight shipping available to continental U.S. for qualifying VDP orders of 70 lb. or less. Free overnight shipping excludes: liftgate fees, residential delivery, non-network carriers, and certain freight intensive items that are shipped FOB.

©2025 GreatNeckTools, Inc. Certain content provided by and is the property of AutoZone Parts, Inc. All rights reserved. AutoZone, AutoZone & Design, Loan A Tool, Duralast, Duralast Gold, Duralast Proven Tough and Duralast ProPower are registered marks of AutoZone IP LLC or one of its affiliates. All other marks are the property of their respective holders. iPhone® and iPad® are registered trademarks of Apple Inc., Android® is a trademark of Google Inc., STP® is a registered trademark of the Energizer Auto, Inc., and Bluetooth® is a trademark of Bluetooth® SIG, Inc. Items requiring freight shipping cannot be delivered outside of the continental United States. For shipping cost to Alaska or Hawaii, please contact Commercial Sales Manager. Ad prices cannot be combined with any other offer. Offers may vary by market. Offers valid while quantities last. Items may not be available at all locations at all times. We reserve the right to limit quantities and to correct pricing errors. Some new items might not be available at the time of print deadline. Prices valid only during sales catalog effective dates. All photographic, clerical, typographical and printing errors are subject to correction. Images shown may not be actual product but represent products or sets which include product. We reserve the right to substitute a like item or an item of greater value on any promotional offer in this publication. Store stock items may be purchased at any local AutoZone store or through your AutoZone Commercial Sales Manager. Bonus items are fulfilled while supplies last and may ship separately. Bonus items may be replaced with like items of the same or greater value.

AZG0225 | SKU 1391458 \$2.99