

Call 901-300-4878



**OEM TOOLS®**

### 72" Stainless Steel 11 Drawer Cabinet and Upper Cabinet

See Page 119

**BONUS**  
**Service Cart**  
VALUE: \$159.99



**GreatLite®**  
MAX OUTPUT  
**1000**  
LUMENS

**E36 Cree  
Rechargeable  
Flashlight Kit**  
EXPE36-E02  
See Page 70

**SAVE  
\$10**  
**59<sup>99</sup>**

### Master Wheel Hub and Bearing Remover/Installer Kit

27213

**BONUS** VALUE: \$74.99

#### Axle Nut Socket Set

24480



See Page 48





**DEDICATED TO HELPING YOUR BUSINESS RUN BETTER**



The AutoZone® Tool and Equipment Team is here to ensure our customers are always satisfied. As our customer, you can expect fast, personalized and professional service. Our customer service associates have over 200 years of combined experience in the tool and equipment industry.

**Call AutoZone® Tool & Equipment at 901-300-4878 for Questions Concerning:**

- Equipment Selection
- Product Delivery
- Service After the Sale
- Product Availability
- Technical Support
- Ordering Capital Equipment

**Call Your AutoZone® Commercial Sales Manager or Go to AutoZonePro.com**

- To Place Orders for Parts, Tools and Equipment
- For Questions Related to Parts and Vehicle Accessories
- For Commercial Credit, Lease or Financing Information

**Businesses can take advantage of IRS S-179 tax credits on equipment purchases.**  
Contact your CPA for details.

**FREE OVERNIGHT SHIPPING**



Free overnight shipping available to continental U.S. for qualifying orders of 70 lb. or less. Free overnight shipping excludes: liftgate fees, residential delivery, non-network carriers, and certain freight intensive items that are shipped FOB.

**IMPORTANT INFORMATION ABOUT RECEIVING YOUR FREIGHT ORDER**

The freight company will call 24 hours prior to delivery. It is important to take or return their calls to schedule delivery. Most items are shipped freight prepaid. Limited access, residential, carrier surcharges, redelivery and storage fees are not included.

**OFFLOADING? Do you need:**



- Items shipped via flatbed and most lifts will require a forklift.
- Palletized items including most capital equipment and tool storage require a liftgate or forklift.
- Drivers will not allow you to break down pallets and offload by hand.
- Inside delivery is not available. Product will be dropped as close as safely possible. Make sure your location is accessible to the truck and driver.
- DO NOT SIGN until you have inspected the freight and confirmed carton/pallet count.

- Refuse shipment and/or notate any discrepancies or possible hidden damage on the bill of lading.
- DO NOT ACCEPT OR SIGN FOR DAMAGED ITEMS. Accepting and signing for a damaged or short shipment without notation releases the carrier and distributor from any claim or responsibility.
- Contact us at 901-300-4878 immediately with any questions or problems with delivery.
- For hidden minor or cosmetic damage, we may at our discretion, choose to send replacement parts.

**ASK BEFORE YOU RETURN**

Many of the Tool and Equipment products are covered by the manufacturer's warranty and will be serviced and repaired in the field.

**Note: Most manufacturers require you to register your products with them before receiving support or service.**

**IF YOU HAVE QUESTIONS ABOUT WARRANTY OR RETURNS CALL 901-300-4878.**

**AUTOZONE® STORE MANAGERS AND COMMERCIAL SALES MANAGERS**

**Call Your Tool & Equipment Team at 901-300-4878 for Questions Regarding:**

- Product Ordering and Availability
- Assisting Customers with Price Quotes
- Service After the Sale
- Help with Outside Buy/EPO Orders

Prices subject to change without notice. Prices do not include applicable taxes, vehicles, tires, rims, installation or optional equipment as shown. Please do not return purchases to the store. For information regarding warranty, repair, or any questions or concerns, call 901-300-4878.

To place orders or for pricing contact your AutoZone® Commercial Sales Manager.  
For product information, availability and product support, **call 901-300-4878.**

## TOOLS AND EQUIPMENT IN THIS ISSUE:

Advanced Driver Systems (ADAS) . . . 14-15	Engine Service . . . . . 41-45	Key Machines . . . . . 125	Shop Presses . . . . . 122
Air Compressors . . . . . 66-67	Engine Stands & Cranes . . . . . 83-84	Lighting & Flashlights . . . . . 68-70	Shop Supplies . . . . . 141-144
Air Conditioning . . . . . 51-61, 113	Evaporative Coolers . . . . . 11-12	Motorcycle Lifts . . . . . 94	Specialty Tools . . . . . 34-40, 114-115
Air Hoses & Reels . . . . . 75	Exhaust Tubing Bender . . . . . 125	Oil Change . . . . . 26-30, 114-115	Surface Prep . . . . . 72, 76
Air Tools & Accessories . . . . . 71-76	Fans . . . . . 11-12	Paint & Body . . . . . 127	Technician Sets . . . . . 24, 79
Alignment . . . . . 85-88	Fluid Handling . . . . . 21-24	Parts Washers . . . . . 123-124	Thread Repair . . . . . 139-140
Automotive Lifts . . . . . 89-96, 115	Generators . . . . . 126	Power Tools & Accessories . . . . . 77-79	Tire Service . . . . . 6, 96-107, 114
Battery Service . . . . . 9, 62-65	Gloves . . . . . 129, 147	Pressure Washers . . . . . 126	Tool Organization . . . . . 120-121
Brake Lathes . . . . . 108	Grease Guns . . . . . 25	Pullers . . . . . 35, 37, 40-43, 47-50, 57, 62, 112, 114, 122, 127	Tool Storage . . . . . 5, 116-119
Brake Service . . . . . 108-112	Hand Tools . . . . . 5-8, 130-138	Ratchets . . . . . 132-133	Torque Wrenches . . . . . 8, 38, 104
Chassis & Suspension . . . . . 46-50	Hardware Kits . . . . . 34, 60, 144	Regulators, Filters, Drains . . . . . 67	TPMS Tools . . . . . 101-102
Cooling System . . . . . 31-33, 113	Heating & Cooling . . . . . 10-12	Rivet Tools . . . . . 39	Tubing . . . . . 75
Creepers & Seats . . . . . 142-143	Heavy Duty . . . . . 113-115	Safety Supplies . . . . . 145-147	Vacuum Pumps . . . . . 53-54
Diagnostics . . . . . 13-20, 113	Inflators . . . . . 73	Scan Tools . . . . . 13-15, 113	Welding & Cutting . . . . . 128-129
Disconnect Tools . . . . . 34, 114	Jacks & Hydraulics . . . . . 9, 80-84, 115	Shop Equipment . . . . . 122-126	Wheel Weights . . . . . 106-107
Drill Bits & Extractor Sets . . . . . 139-140	Jump Starters . . . . . 9, 63		Wrenches . . . . . 130

## BRANDS IN THIS ISSUE:

ABAC . . . . . 66-67	Crushproof Tubing Co. . . . . 11	Lisle . . . . . 27-28, 30, 34, 36, 41-42, 44-45, 48-49, 106, 111, 139-140, 145	Robinair . . . . . 52-53
Access Tools . . . . . 39	CTA . . . . . 29, 41	Livernois . . . . . 45	Rotary . . . . . 87, 91, 97, 114
Air Movement Solutions . . . . . 12	Custom Leather Craft . . . . . 119	logix . . . . . 129	SAS . . . . . 145-147
AirSept . . . . . 34, 61	Cutting Edge . . . . . 84	Mahle . . . . . 24, 33, 51, 53	Shark . . . . . 27, 76-77, 79, 95, 103, 109, 123, 129
ALLDATA . . . . . 13	Dannmar . . . . . 93	Manatec . . . . . 100	Sheffield . . . . . 119, 137
Allstart . . . . . 63	Duralast . . . . . 5-9	Marson . . . . . 39	Slip-N-Grip . . . . . 141
American Forge & Foundry . . . . . 81-84, 115, 122	Ecotechnics . . . . . 52-53	Mastercool . . . . . 12, 16, 31, 34, 51, 53-61, 111, 113	Solar . . . . . 63
Arrow Pneumatics . . . . . 67	Electronic Specialties/ES . . . . . 18-19, 37	MaxJax . . . . . 94	SP Tools . . . . . 68
Associated . . . . . 62-65	Energy Logic . . . . . 10	Mi-T-M . . . . . 67, 126	SRI . . . . . 123-124
Astro . . . . . 73, 84, 102	FIX-A-THRED . . . . . 139	Midtronics . . . . . 62	Steck . . . . . 36, 39, 83, 143
ATD . . . . . 69, 127	FJC Inc. . . . . 55, 61	Mighty Seven/M7 . . . . . 71-73	Streamlight . . . . . 69
ATEQ . . . . . 101	Flexzilla . . . . . 69, 75	Milton . . . . . 73, 102	SUNEX . . . . . 74
Autel . . . . . 15-17, 65, 102	Forward Lift . . . . . 88, 91	Mityvac . . . . . 20-22, 110	Sunfire . . . . . 10
Balcrank . . . . . 24, 27	GearWrench . . . . . 130-131	MotorVac . . . . . 19, 24, 112	SUR&R . . . . . 19, 28, 34, 144
Baseline . . . . . 98	GreatLite . . . . . 69-70	OEMTOOLS . . . . . 11, 17, 19, 21-50, 53-57, 59-62, 65, 68, 70-84, 87, 94, 101-107, 109-112, 114-115, 118-123, 125, 127-143, 146-147	SureBilt . . . . . 30
BelAire . . . . . 67	GreatNeck . . . . . 68, 70, 131, 136-138	ONE-Direct Sensors . . . . . 101	Sure Shot . . . . . 112
BendPak . . . . . 84, 88, 92-96, 115, 125	H&S Autoshot . . . . . 127-129	Phoenix Systems . . . . . 110, 112	Sylvania . . . . . 69
BigVac . . . . . 125	Hardware Machinery . . . . . 60, 144	Portacool . . . . . 12	Symtech . . . . . 125
Branick . . . . . 47, 106	Hofmann . . . . . 85-86, 88, 97, 100	Power Probe . . . . . 18, 37	TEXA . . . . . 15, 52, 113, 145
BRM . . . . . 42, 112, 123	Homak . . . . . 116-119	Pro-Cut . . . . . 108	Thexton . . . . . 32
Cal-Van . . . . . 33-34, 37, 43, 105, 127, 139-140	Hunter Fans . . . . . 12	QSP . . . . . 47, 87	Titan . . . . . 28
CEMB . . . . . 87, 98-99	Ilco . . . . . 125	Quality Lifts . . . . . 90	TMR/The Main Resource . . . . . 103
Central Tools . . . . . 38, 104, 109	Induction Innovations . . . . . 129	QuickJack Lifts . . . . . 94	TOPDON . . . . . 14, 16, 62-63, 65
Challenger Lifts . . . . . 84, 88, 90, 94-95, 115	Ingersoll Rand . . . . . 71-73	Ranger . . . . . 30, 82-84, 96, 98, 100, 108, 124	Traxion . . . . . 142
Champion Air Compressors . . . . . 67	Innova . . . . . 20	Rapidair . . . . . 75	Tuxedo . . . . . 89
Champion Power Equipment . . . . . 126	IPC . . . . . 126	Redline . . . . . 17, 31	UView . . . . . 33, 58-59
Coats . . . . . 87-88, 90, 97, 99, 103, 114	Jackson . . . . . 129, 146		Viking . . . . . 81, 119
CoolBoss . . . . . 12	John Dow . . . . . 10, 23, 34, 144		VIM Tools . . . . . 110
CPS . . . . . 51, 53-54, 57, 60, 113	Ken-Tool . . . . . 114, 122		Water Works . . . . . 124
	Lanair . . . . . 10		Xtra Seal . . . . . 101, 105-106
	Lang . . . . . 19, 111		
	Lincoln . . . . . 23, 25-26, 30, 75, 114, 123		

Prices subject to change without notice. Prices do not include applicable taxes, vehicles, tires, rims, installation or optional equipment as shown. Please do not return purchases to the store. For information regarding warranty, repair, or any questions or concerns, call 901-300-4878.

# NEW ITEMS & DEALS

Offers Good While Supplies Last Through March 31, 2025

**200A Multi MIG Synergic, TIG and Stick Welder (115-230VAC)**

SKU OUTSIDE BUY/EPO HSAHSW-6420

**2,199<sup>99</sup>**

**NEW**



**BONUS VALUE: \$214.99**

**Welding Cart with Cylinder Support**  
HSAHSW-7000

With Purchase of: HSAHSW-6420

See More **WELDING** on Pages 128-129

**2-in-1 2200 Peak Amp Jump Starter and Tire Inflator**

SKU 1485043 TPDV2200AIR

**129<sup>99</sup>**

**NEW**

Jump-Start, Inflate, Charge and Illuminate



**6/12V, 40A Standard Duty Wheel Charger**

SKU 344795 ASCUS20

**429<sup>99</sup>**

**NEW**

Safe in Any Weather  
Made in the U.S.A.



See More **BATTERY SERVICE** on Pages 62-65

**50' EVO Reel, Lynx 5:1 HD Pump, 275 Gal**

SKU OUTSIDE BUY/EPO BAL1135-017

**3,879<sup>99</sup>**

**NEW**

- Double Wall Construction
- UL 2258 Certified
- Compatible Fluids: DEF, Diesel, Lubricants
- Compact Design



See More **FLUID HANDLING** on Pages 21-24

**Axone Light Car Diagnostic Kit (Multihub)**

SKU OUTSIDE BUY/EPO TEXAXLTAKMH

**4,999<sup>99</sup>**

**NEW**



See More **DIAGNOSTICS** on Pages 13-20, 113

**Battery Powered 20" Floor Scrubber**

SKU OUTSIDE BUY/EPO IPCCT50

**4,914<sup>99</sup>**

**NEW**



See More **SHOP EQUIPMENT** on Pages 122-126

**16" Long Reach Long Nose Pliers Set - 3 Piece Set**

SKU 1142915 22660

**29<sup>99</sup>** REG. \$39.99

**SAVE \$10**



See More **HAND TOOLS** on Pages 130-138

**RC-55E and 1300 Series Tire Service Combo**

SKU OUTSIDE BUY/EPO AMMCOMB02

**13,299<sup>99</sup>**



AMM80013002D



AMM8560995001

AMM8560995001	\$7,699.99
AMM80013002D	\$5,949.99
Regular Price	\$13,649.98
<b>COMBO PRICE</b>	<b>\$13,299.99</b>
<b>SAVINGS</b>	<b>\$349.99</b>

**SAVE \$349**

See More **TIRE SERVICE** on Pages 96-107, 114

**1,100 Lb. 2 Stage Telescoping Transmission Jack**

SKU 1089028 24790

**499<sup>99</sup>** REG. \$699.99

**SAVE \$200**

Foot Pedal Pump and Release for Hands-Free Operation

76" REACH



See More **JACKS & HYDRAULICS** on Pages 80-84, 115

## NEW Duralast TOOL STORAGE

**Duralast** **359<sup>99</sup>**  
**42 in. 4-Drawer Top Chest, Blue**  
 SKU 1354163

- 21-gauge steel construction
- 100 lb. soft-close full-extension drawers with liners
- Built-in power strip (4 outlets & 2 USB ports)
- 7,668 cubic inches of storage
- 400 lb. total weight capacity
- Combine with 1354168 (sold separately)



- 21-gauge steel construction
- 100 lb. soft-close full-extension drawers with liners
- 5"x2" heavy-duty casters to support up to 1,200 lbs.
- 10,532 cubic inches of storage
- 800 lb. total weight capacity
- Combine with 1354163 (sold separately)

**42 in. 9-Drawer Tool Cabinet, Blue**  
 SKU 1354168

**449<sup>99</sup>**

**Duralast**  
**30 in. 5-Drawer Mechanic's Cart**  
 BLUE SKU 1354167  
 BLACK SKU 1354164

**329<sup>99</sup>**



- High-capacity, full-extension ball bearing drawer slides
- 90-degree lid opening with dual gas struts
- 15,000 cubic inches of storage
- 700 lb. total weight capacity

**Duralast** **249<sup>99</sup>**  
**30 in. 4-Drawer Technician Cart**  
 BLUE SKU 1354165  
 BLACK SKU 1354166



- High-capacity, full-extension ball bearing drawer slides
- 90-degree lid opening with dual gas struts
- 12,600 cubic inches of storage
- 580 lb. total weight capacity

## SPECIAL DEALS

**Duralast**  
**1/4", 3/8", 1/2" Drive**  
**435PC Mechanic's Tool Set**  
 SKU 1089589  
 Storage NOT Included

**429<sup>99</sup>**



**\$1,850 Value**

- Features 237 Chrome Sockets, 51 Wrenches, 42 Impact Sockets, 6 ratchets & more!
- The most tools for your money, all guaranteed for life

**Duralast**  
**1/4", 3/8", 1/2" Drive**  
**335PC Mechanic's Tool Set**  
 SKU 1092684  
 Storage NOT Included

**269<sup>99</sup>**



**\$1,350 Value**

- Features 210 Chrome Sockets, 41 Wrenches, 3 Ratchets & more!
- Professional Grade Tool Selection, All Guaranteed for Life

**Duralast** **16<sup>99</sup>**  
**10PC 1/4", 3/8" Drive**  
**10MM Socket Set**  
 SKU 582151



- The Duralast 10pc 10mm socket set takes the need of the 10mm socket, and provides a solution for any application
- Chamfered lead-ins help to provide fast and easy placement of sockets and accessories onto drive

**Duralast** **19<sup>99</sup>**  
**9PC Triple Square Bit Set**  
 SKU 1077622



- Cold formed Alloy Steel socket base and S2 tool steel bit heat treated for superior durability and strength
- Bit sockets attach to drive tools, such as ratchet or breaker bar, providing a long handle for leverage
- Full polished chrome finish socket easily wipes clean of oil and dirt

**Duralast** **44<sup>99</sup>**  
**36PC Master Bit Socket Set**  
 SKU 569654



- Cold formed Alloy Steel socket base and S2 tool steel bit heat treated for superior durability and strength
- Full polished chrome finish socket easily wipes clean of oil and dirt
- Bit sockets attach to drive tools, such as ratchet or breaker bar, providing a long handle for leverage

## Duralast® MECHANIC'S TOOL SETS

**Duralast NEW!**

**90PC EVA Mechanic's Tool Set**

SKU 1382518

**64<sup>99</sup>**



- 1/4-in and 3/8-in drive mechanic's tool set
- EVA foam provides an easy and organized storage solution that can be placed directly into a toolbox
- Includes 100 position ratchets (1/4-in and 3/8-in drive)
- Sockets feature off-corner loading design to help prevent the rounding of fasteners

**Duralast NEW!**

**9PC Tire Changing Kit**

SKU 1382480

**99<sup>99</sup>**



- 1/2-in drive sockets, breaker bar, extension & torque wrench
- Torque wrench has range of 50 - 250 ft/lbs
- 12-point deep well sockets fit into wheel recesses and a 5 in. extension provides access for inset wheels or for use on vehicles with fender flares

**Duralast**

**265PC Mechanic's Tool Set**

SKU 1077624

**179<sup>99</sup>**



- 1/4-in, 3/8-in, and 1/2-in drive mechanic's tool set
- 6-point standard and deep sockets (1/4-in, 3/8-in drive) and 12-point standard sockets (1/2-in drive)
- Sockets feature off-corner loading design to help prevent the rounding of fasteners
- Alloy Steel sockets and drive tools heat treated for superior strength

**Duralast**

**180PC Mechanic's Tool Set**

SKU 52378

**119<sup>99</sup>**



- 1/4-in, 3/8-in, and 1/2-in drive mechanic's tool set
- 6-point standard and deep sockets (1/4-in, 3/8-in drive) and 12-point standard sockets (1/2-in drive)
- Sockets feature off-corner loading design to help prevent the rounding of fasteners
- Alloy Steel sockets and drive tools heat treated for superior strength

**Duralast**

**90PC Mechanic's Tool Set**

SKU 52377

**89<sup>99</sup>**



- 1/4-in and 3/8-in drive mechanic's tool set
- 6-point standard and deep sockets
- Sockets feature off-corner loading design to help prevent the rounding of fasteners
- Alloy Steel sockets and drive tools heat treated for superior strength

**Duralast**

**60PC Mechanic's Tool Set**

SKU 15881

**59<sup>99</sup>**



- 3/8-in drive mechanic's tool set
- 6-point standard and deep sockets
- Sockets feature off-corner loading design to help prevent the rounding of fasteners
- Alloy Steel sockets and drive tools heat treated for superior strength

**Duralast**

**45PC Mechanic's Tool Set**

SKU 15879

**39<sup>99</sup>**



- 1/4-in drive mechanic's tool set
- 6-point standard and deep sockets
- Sockets feature off-corner loading design to help prevent the rounding of fasteners
- Alloy Steel sockets and drive tools heat treated for superior strength
- Premium S2 steel bits for durability

## Duralast® IMPACT TOOLS



### Duralast Impact Tools, Built to Withstand the Toughest Jobs

- Duralast impact products are created with Chrome Molybdenum (Cr-Mo) steel for strength and durability in impact use
- Black oxide finish resists corrosion and withstands impact application
- All sockets feature patented off corner loading design, to reduce rounding of fasteners
- Innovative 3/8" Drive impact sockets feature a thin wall design for additional access

#### Duralast

##### 7PC Impact Hex Bit Socket Sets

MM SKU 1077628 | SAE SKU 1077626



**26<sup>99</sup>** each

- Metric Set Includes: (7) 1/2" Drive Impact Hex Bit Sockets: 9, 10, 11, 12, 13, 14, 15 mm
- SAE Set Includes: (7) 1/2" Drive Impact Hex Bit Sockets: 3/8", 7/16", 1/2", 9/16", 5/8", 11/16", 3/4"

#### Duralast

##### 2PC 1/2" Drive Impact Extension Set

SKU 914182



**20<sup>69</sup>**

- Set Includes: (2) 1/2" Drive Impact Extensions: 6", 12"
- Forged Chrome Molybdenum Alloy Steel for strength and durability in impact use

#### Duralast

##### 4PC Impact Flip Socket & Extension Kit

SKU 1077627



**24<sup>29</sup>**

- Set Includes: (3) 1/2" Drive Flip Impact Sockets- 21 mm x 22 mm, 7/8" x 15/16", 3/4" x 13/16". (1) 1/2" Drive Impact Extension: 3"
- Forged Chrome Molybdenum Alloy Steel for strength and durability in impact use

#### Duralast

##### 10PC 3/8" Drive Thin Wall Impact Socket Sets

MM SKU 1227805 | SAE SKU 1227807



**29<sup>69</sup>** each

- Metric Set Includes: (9) 3/8" Drive Thin Wall Impact Sockets: 8, 9, 10, 12, 13, 15, 16, 17, 18 mm. (1) 1/4" hex x 3/8" drive adapter.
- SAE Set Includes: (9) 3/8" Drive Thin Wall Impact Sockets: 5/16", 11/32", 3/8", 7/16", 1/2", 9/16", 5/8", 11/16", 3/4". (1) 1/4" hex x 3/8" drive adapter.

#### Duralast

##### 10 pc 1/2" Drive Deep Metric Impact Sockets

SKU 914180



**29<sup>69</sup>**

- Set Includes: (10) 1/2" Drive Deep Metric Impact Sockets: 10, 11, 12, 13, 14, 15, 16, 17, 18, 19mm
- Forged Chrome Molybdenum Alloy Steel for strength and durability in impact use
- Chamfered lead-ins help to provide fast and easy placement of sockets and accessories onto drive

#### Duralast

##### 10PC 1/2" Drive Shallow Impact Socket Sets

MM SKU 914179  
SAE SKU 914183



**23<sup>39</sup>** each

- Metric Set Includes: (10) 1/2" Drive Metric Impact Sockets: 11, 12, 13, 15, 16, 17, 19, 21, 22, 24 mm
- SAE Set Includes: (10) 1/2" Drive SAE Impact Sockets: 7/16", 1/2", 9/16", 5/8", 11/16", 3/4", 13/16", 7/8", 15/16", 1"
- Forged Chrome Molybdenum Alloy Steel for strength and durability in impact use

#### Duralast

##### 9PC 1/2" Drive Deep SAE Impact Sockets

SKU 569664



**29<sup>69</sup>**

- Set Includes: (9) 1/2" Drive Deep SAE Impact Sockets: 1/2", 9/16", 5/8", 11/16", 3/4", 13/16", 7/8", 15/16", 1"
- Forged Chrome Molybdenum Alloy Steel for strength and durability in impact use
- Chamfered lead-ins help to provide fast and easy placement of sockets and accessories onto drive

#### Duralast

##### 5PC Impact Adapter Set

SKU 914056



**20<sup>69</sup>**

- Set Includes: (1) 1/4" Drive Impact Adapter, (2) 3/8" Drive Impact Adapters, (2) 1/2" Drive Adapters
- Forged Chrome Molybdenum Alloy Steel for strength and durability in impact use
- Chamfered lead-ins help to provide fast and easy placement onto fasteners

## Duralast® TORQUE WRENCHES



### Work Precisely with Duralast Torque Wrenches

- All Duralast Torque wrenches have precise +/- 4% accuracy in tightening direction
- Audible and mechanical torque indicators as target torque is reached
- Knurled handle design for a secure grip
- All torque wrenches come with a blow mold tray for convenient storage
- Micrometer (clicker) torque wrenches include twist collar to lock torque setting in place

### Duralast

#### 3/8" Drive Torque Wrench

SKU 914017



**29<sup>99</sup>**

- Torque range of 5-80 ft-lbs.
- Factory calibrated to +/- 4% accuracy in clockwise direction
- Twist collar locks torque setting in place
- Reversible, ratcheting head and alloy steel construction
- Knurled handle for added grip

### Duralast

#### 1/2" Drive Torque Wrench

SKU 914018



**34<sup>99</sup>**

- Torque range of 20-150 ft-lbs..
- Factory calibrated to +/- 4% accuracy in clockwise direction
- Twist collar locks torque setting in place
- Reversible, ratcheting head and alloy steel construction
- Knurled handle for added grip

### Duralast

#### 1/2" Drive Torque Wrench

SKU 1146659



**54<sup>99</sup>**

- 50 to 250 ft-lbs range perfect for lug nut applications
- Factory calibrated to +/- 4% accuracy in clockwise direction
- Twist collar locks torque setting in place
- Reversible, ratcheting head and alloy steel construction
- Knurled handle for added grip

### Duralast

#### 3/8" Drive Electronic Torque Wrench

SKU 1227964



**119<sup>99</sup>**

- 20-100 ft-lbs range ideal for engine work and smaller vehicle lug nuts
- Torque accuracy of +/- 2% clockwise / +/- 3% counter clockwise
- 6 button design allows for easily switching between different torque units (N-m, Kg-m, Ft-Lb, In-Lb)
- Reversible, ratcheting head and alloy steel construction
- Comfort grip handle and housing are solvent resistant



## Duralast® LIFT EQUIPMENT & BATTERY CHARGERS

### Duralast GOLD 3 Ton Aluminum Floor Jack SKU 1276166



- Light weight design for easy mobility
- 3 ton capacity dual pump piston with universal release
- Slow descent release

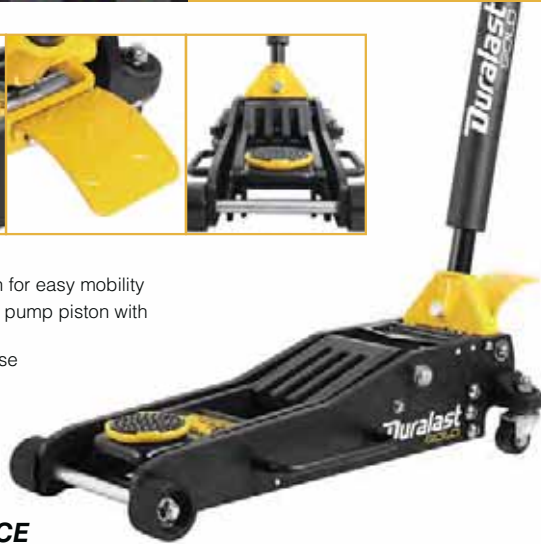

### Duralast GOLD 3-1/2 Ton Professional Foldable Garage Jack SKU 1276164



- 30" lift height with adapter
- Dual piston lift pump
- Slow descent release for controlled load lowering



FEATURE PRICE  
**249<sup>99</sup>**

FEATURE PRICE  
**229<sup>99</sup>**

### Duralast 4 Ton Quick Start Jacks SKU 1404838



**69<sup>99</sup>**

- Includes 2 jack stands
- Patented, quick-start design, with a lifting range of 13-7/16" to 20"
- Locking pawl with built-in counterweights that secures the ratchet bar

### Duralast 3 Ton Garage Jack SKU 1399157



**129<sup>99</sup>**

- Heavy-duty steel construction - high-grade steel with powder coated finish
- Lift range: 5.1" - 18.6"
- 1-Year Warranty

### Duralast 3 Ton Low Profile Jack SKU 1399156



**169<sup>99</sup>**

- Low profile frame - greater access for low clearance vehicles
- Lift range: 3.3" - 20.3"
- 1-Year Warranty

### Duralast 2 Ton Off-Road Jack SKU 1399159



**279<sup>99</sup>**

- Oversized wheels and full length skid plate - ideal for off-road conditions
- Includes 10" lift arm extension adapter
- 1-Year Warranty

### Duralast 250 Amp 12 Volt Battery Charger SKU 1277303

**149<sup>99</sup>**

- The DL-250D is compatible with 12-volt standard, lithium, AGM, gel, and deep-cycle batteries
- The 250-amp engine start is strong enough to jump start cars, SUVs, trucks, and boats
- Manual operation controlled by 135-minute timer and manual rate selection knob
- Built-in ammeter lets you monitor the complete charging process



### Duralast Lithium Battery Booster/Jump Pack SKU 567656

**99<sup>99</sup>**

- Powerful 1200-amp jump start is strong enough for cars, trucks, motorcycles, boats, SUVs, and other large engines
- 150-PSI air compressor features a digital pressure gauge making it easy to inflate tires, toys, mattresses, and more
- The 2.4-amp USB port charges smartphones and other mobile devices two times faster than a standard USB charger"



# HEATING & COOLING

## Shop Heaters



On-board  
air compressor



Burn No.2 to 90W  
and synthetics



Small  
footprint

**Stop paying to have your waste oil hauled off!**  
Save and burn it for **FREE** heat this winter.



### 75H Waste Oil Furnace with Built-In 10 Gal. Tank

FURNACE	BTUs	HEATS UP TO	PART NO.	PRICE
EL-75	75,000	1,750 Sq. Ft.	ENL11075104	<b>3,999.99</b>

### Waste Oil Heater Complete Systems\*

FURNACE	BTUs	HEATS UP TO	PART NO.	PRICE	Reg. Price	Savings
EL-140	140,000	3,500 Sq. Ft.	ENL01140103	<b>11,399.99</b>	12,049.99	<b>\$650</b>
EL-200	200,000	5,000 Sq. Ft.	ENL01200104	<b>12,649.99</b>	13,349.99	<b>\$700</b>
EL-350	350,000	8,500 Sq. Ft.	ENL01350104	<b>14,399.99</b>	16,049.99	<b>\$1,650</b>

\* Complete systems include waste oil furnace and 250 gallon tank, swing-away burner with built-in air compressor, low-fuel cutoff, draft gauge, drain valve and Class A flue kit. Not for sale in CA

To Confirm Price, Availability and Ordering Instructions on Outside Buy/EPO, Call 901-300-4878



## Lanair

# EXTREME PERFORMANCE BURNER

**FREE Strainer Pan & Tank Gauge Included!**

	Heater Model	BTUs	Heats up to	Part Number	Price
Thru-roof chimney	XT1503	150,000	3,500 sq. ft.	LANXT150C	<b>9,749.99</b>
	XT2003	200,000	5,000 sq. ft.	LANXT200C	<b>10,099.99</b>
	XT2503	250,000	8,500 sq. ft.	LANXT250C	<b>12,949.99</b>
	XT3003	300,000	10,000 sq. ft.	LANXT300C	<b>13,649.99</b>

**Value Package 3** \*Packages Include 215 Gallon Tank and 6" chimney kit.  
For Outside Buy/EPO, Call 901-300-4878

Not For Sale in CA



**NEW  
XT  
SERIES**

## Sunfire

### Portable Radiant Heaters

- Quiet, Clean, Odorless
- Safe for Indoor Commercial Use

#### 80,000 BTU

SKU **OUTSIDE BUY/EPO**  
SFRSF80

**1,799<sup>99</sup>**

- Heats up to 1,900 Sq. Ft
- Diesel or Kerosene
- 6 Gallon Tank

#### 120,000 BTU

SKU **OUTSIDE BUY/EPO**  
SFRSF120

**2,499<sup>99</sup>**

- Heats up to 2,800 Sq. Ft
- Diesel or Kerosene
- 14 Gallon Tank

#### 150,000 BTU

SKU **OUTSIDE BUY/EPO**  
SFRSF150

**3,199<sup>99</sup>**

- Heats up to 3,500 Sq. Ft
- Diesel
- 19 Gallon Tank

**SUNFIRE**

**NO SMELL NO FUMES**



SFRSF150

**70** Thermostat Connection Capability

## Exhaust Extraction



### Portable Exhaust Extraction System

SKU **OUTSIDE BUY/EPO**  
DOWEV5100 **1,449<sup>99</sup>**

- Works with Standard 3" Exhaust Hoses and "Y" Hose Adapters
- Captures Fumes and Discharges Them Safely Up to 30' Away
- Mobile Base Makes it Easy to Position and Move Around the Shop
- Uses Standard 110V Current
- Not for Use on Diesel
- Optional "Y" Hose Adapter Available for Dual-Exhaust Vehicles



To Confirm Price, Availability and Ordering Instructions on Outside Buy/EPO, Call 901-300-4878

Prices subject to change without notice. Prices do not include applicable taxes, vehicles, tires, rims, installation or optional equipment as shown. Please do not return purchases to the store. For information regarding warranty, repair, or any questions or concerns, call 901-300-4878.

# HEATING & COOLING

TO ORDER, contact your Commercial Sales Manager or go to [AutoZonePro.com](http://AutoZonePro.com)

HEATING & COOLING

## Exhaust Hoses

### Flarelock Hoses

- Made Exclusively for Cars and Small Trucks
- End is Flared to Permit Connection of 2 or More Links at a Time

**2.5" x 11'**

SKU 977557 ACSFLT250 **119<sup>99</sup>**

**3" x 11'**

SKU 977559 ACSFLT300 **149<sup>99</sup>**

**3.5" x 11'**

SKU 977589 ACSFLT350 **209<sup>99</sup>**

**4" x 11'**

SKU 977590 ACSFLT400 **229<sup>99</sup>**



### 2.5" Y-Assembly Kit with F250 Adapter

SKU 977549 ACSYA250 **199<sup>99</sup>**

- Designed for Connecting a Single Hose to Vehicles with Dual Exhaust System



### 3" Y-Assembly Kit with F300 Adapter

SKU OUTSIDE BUY/EPO ACSYA300 **249<sup>99</sup>**

For Outside Buy/EPO, Call 901-300-4878



## CRUSHPROOF TUBING COMPANY

### Door Port Adapters

#### For 2.5" Hose (Rubber)

SKU 977551 ACSDF25 **49<sup>99</sup>**

- Rubber Garage Door Port Adapter
- Designed for 2-1/2" ID



#### For 3" Hose (Aluminum)

SKU 977552 ACSADF30 **49<sup>99</sup>**

- Aluminum Port Allows Hose to Be Vented Through the Door



#### For 4" Hose (Aluminum)

SKU 977554 ACSADF40 **74<sup>99</sup>**

- Use on 1" Thick Doors



### 2.5" Service Station Kit

SKU 977547 ACSDSS25 **259<sup>99</sup>**

- 2 Each - 4' x 2-1/2" Hoses
- 1 Each - 6' x 2-1/2" Hose
- 1 Each - 2-1/2" Rubber "Y" Connector
- 2 Each - Straight Tailpipe Adapter, Hook and Chain
- 1 Each - Splice Connector



### 3" Service Station Kit

SKU 977548 ACSDSS30 **264<sup>99</sup>**

- 2 Each - 4' x 3" Hoses
- 1 Each - 6' x 3" Hose
- 1 Each - 3" Rubber "Y" Connector
- 2 Each - Straight Tailpipe Adapter, Hook and Chain
- 1 Each - Splice Connector



### Bell Hose Adapters

- Designed for Easy Adapting to All Sorts of Tailpipes
- Connects with Ball and Snap

#### 2.5" Adapter

SKU 977544 ACSRA250 **54<sup>99</sup>**

#### 3" Adapter

SKU 977545 ACSRA300 **54<sup>99</sup>**



## Raise Productivity

Unique high efficiency propeller design is quiet and delivers airflow over long distances.

Keep your technicians cool and comfortable.



## Evaporative Coolers

### 5300 CFM

SKU 213172 23969 **799<sup>99</sup>**

- 1/3 HP 3 Speed Motor
- Water Capacity: 14.6 Gallons
- Cooling Area: 1,600 Sq. Ft.
- Dimensions: 45" x 17" x 28"
- Weight: 56 Lb.
- GFCI Plug for Safe Outdoor Use

### 3100 CFM

SKU 213184 23968 **599<sup>99</sup>**

- 1/5 HP 3 Speed Motor
- Water Capacity: 10.3 Gallons
- Cooling Area: 950 Sq. Ft.
- Dimensions: 37" x 17" x 25"
- Weight: 39 Lb.
- GFCI Plug for Safe Outdoor Use



### Replacement Media Sets

#### For 23969/23977

**5300 CFM**  
SKU 1485036 HESCP610 **129<sup>99</sup>**

#### For 23968/23976

**3100 CFM**  
SKU 1485034 HESCP370 **89<sup>99</sup>**

## Floor Fan



### 20" High Velocity Floor Fan

SKU 688200 OEM24870 **59<sup>99</sup>**

- CFM: 4500
- Precision-Balanced Aluminum Fan Blades and Energy-Efficient Motor Optimize Airflow Output
- 3-Speed Motor Allows Operator to Control Airflow Volume
- 5' UL Listed Power Cord



TILT



## Pedestal Fan



### 30" Oscillating Pedestal Fan

SKU 592248 OEM24885 **249<sup>99</sup>**

- CFM: 9500
- 5 Aluminum Blades
- 6' UL Listed Power Cord
- Adjustable Stand Height



TILT



OSCILLATING



Customer Responsible For Offloading, Liftgate Service Available.

Prices subject to change without notice. Prices do not include applicable taxes, vehicles, tires, rims, installation or optional equipment as shown. Please do not return purchases to the store. For information regarding warranty, repair, or any questions or concerns, call 901-300-4878.

AZG0125

11

# HEATING & COOLING

## Industrial Fans

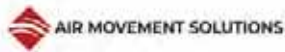

**More Air, Less Noise Means Improved Comfort and Productivity**

- Output: 43,000 CFM
- 43.4 DB
- 110V

### AirMobile 59" Fan

SKU **OUTSIDE BUY/EPO**  
AMS81011300

**3,459<sup>99</sup>**

- Industrial Grade Casters



### AirFocus 59" Variable Speed Fan

SKU **OUTSIDE BUY/EPO**  
AMS81011304

**2,989<sup>99</sup>**

- Wall or Ceiling Mount

### AirFocus 59" Single Speed Fan

SKU **OUTSIDE BUY/EPO**  
AMS81011308

**2,549<sup>99</sup>**

- Wall or Ceiling Mount



### ECO Fan 8' Kit

SKU **OUTSIDE BUY/EPO**  
HNT81011522-1P

**5,599<sup>99</sup>**

- Powerful and Economical
- Direct-Drive Motor
- Whisper-Quiet Air Circulation

**ECO Fans Available in Diameters: 8' to 24'**



### Titan Fan 14' Kit

SKU **OUTSIDE BUY/EPO**  
HNT81011517-1P

**7,349<sup>99</sup>**

- Highest Performance and Versatility
- Direct-Drive Motor
- Whisper-Quiet Air Circulation

**Titan Fans Available in Diameters: 14' to 24'**

**Hunter Fan Kits Include: Down Rod, HMI Controller and VFD Control Panel**

To Confirm Price, Availability and Ordering Instructions on Outside Buy/EPO, Call 901-300-4878

## Evaporative Coolers



- Equipped with Kuul Comfort MicroTech™ Evaporative Media
- Oscillating Louvers Help Cool a Larger Area
- Liquid Level Indicator with Automatic Pump Shutoff
- Lifetime Warranty on Evaporative Cooler Housing

### Apex 2000

SKU **1392329**  
PRCA20001A1

**3,789<sup>99</sup>**

- Cooling: 2,000 Sq. Ft.
- Dimensions: 54" (W) x 30" (D) x 68" (H)



- 80W 4000 Lumens Adjustable LED Floodlight
- Anion Negative Ion Air Purifier
- Low Level Shutoff
- Built-In Bluetooth® Audio Player and Speakers
- Wireless Remote Control

### CB-26SL

SKU **1400045**  
CLBCB-26SL

**2,899<sup>99</sup>**

- Max. Airflow: 7,115 CFM
- Cooling Area: 3,055 Sq. Ft.
- Fan Diameter: 26"



## Blower Fans



### 300 CFM Blower Fan

SKU **1392323**  
MSC20300-A

**119<sup>99</sup>**

- 120 Volts, 60 Hz
- For Indoor or Outdoor Use
- 3-Speed Switch (High, Medium, Low)
- 4-Position Adjustment Feet
- 8.5 Ft. Cord Length



### Heater Attachment for 300 CFM Blower

SKU **OUTSIDE BUY/EPO**  
MSC20300-HTR

**69<sup>99</sup>**

- Converts Your 300 CFM Portable Blower into a Heater for Your Garage or Work Space
- 1320 Watts, 5000 BTU
- Fits Many Popular Brands (300 CFM Only. Not for 1,200 CFM Fans.)



**We Offer the Full Line of Portacool and Cool Boss Evaporative Coolers and Accessories**

# ALLDATA Diagnostics<sup>®</sup>

Your all-in-one scan tool solution with the power of ALLDATA built in

Turns any tablet into a pro-level scan tool

Includes VCI hardware PLUS unlimited scans

Seamless access to ALLDATA's #1 repair info

Do quick vehicle scans from your phone

**SEE IT IN ACTION**  
**(888) 726-3211**  
**ALLDATA.com**

**ALLDATA<sup>®</sup>**  
AUTOMOTIVE INTELLIGENCE<sup>®</sup>

©2024 ALLDATA LLC. ALLDATA, Automotive Intelligence, ALLDATA Repair, ALLDATA Collision, ALLDATA Diagnostics, ALLDATA Shop Manager, ALLDATA Tech-Assist and ALLDATA Mobile are registered trademarks and ALLDATA Manage and ALLDATA Community are marks of ALLDATA LLC. AutoZone is a registered trademark of AutoZone IP LLC. All other marks are property of their respective owners.

# DIAGNOSTICS

## TopDon ADAS

### High-End Diagnostic Functionality and World-Class Support

- Foldable Calibration Frame That Offers Unmatched Portability and Convenience
- Compatible with Phoenix Diagnostic Scanner (Not Included)

**TOPDON®**

#### Phoenix ADAS Mobile Deluxe Package

SKU **OUTSIDE BUY/EPO**  
TPDPXADASDEL **16,899<sup>99</sup>**

- Includes: All of the 24 LDW Targets, as Well as AVM AS (Asian Rear 360 Surround View Camera), AVM EU (Europe Rear 360 Surround View Camera) and AVM AM (American Rear 360 Surround View Camera) Targets

#### Targets Included

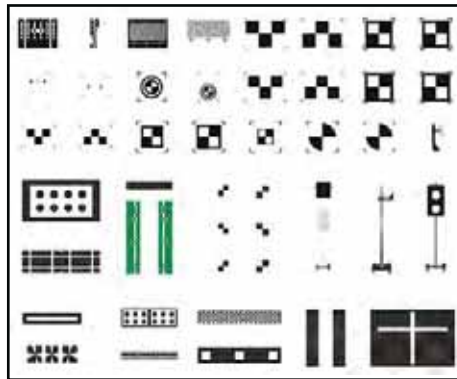

#### Phoenix ADAS Mobile Max Package

SKU **OUTSIDE BUY/EPO**  
TPDPXADASMAX **28,399<sup>99</sup>**

- Includes: 24 LDW Targets, as Well as the ADAS Rear Camera and AVM Panels (US, Euro and Asian); Doppler Simulator (LAC05-04); Radar Cone Target Configuration (LAM05-02) and Corner Reflector (LAC05-03)
- Also Includes: Night Vision System (NVS), Lidar, Around View Monitoring (AVM), Rear Camera Warning (RCW), Lane Departure Warning (LDW) and Other (LAM01-11 and LAC04-17)

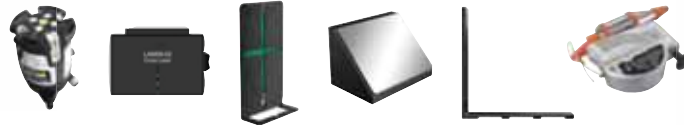

To Confirm Price, Availability and Ordering Instructions on Outside Buy/EPO, Call 901-300-4878

## TopDon

#### ArtiDiag800BT Mid-Level Diagnostic Powerhouse

SKU **1331502**  
TPDART800BT **479<sup>99</sup>**

- Full System Diagnostics for 54 Makes
- AutoVin Technology
- Bluetooth VCI Communications
- Read Version Information
- Reads and Graphs Live Data
- OBDII Functions



#### T-Ninja Pro Key Programming Via OBD2

SKU **1340225**  
TPDNINJAPRO **499<sup>99</sup>**

- Pin Reading and Key Learning
- Remote Control Learning
- Deletes Keys
- All Keys Lost
- Reads and Clears Fault Codes
- Supports Wireless and Wired Dual Connectivity



**TOPDON®**

#### Phoenix Smart Diagnostic System

SKU **1331482**  
TPDPXSMART **2,299<sup>99</sup>**

- Android Based OE-Level Coverage
- 10.1" HD Touch Screen
- TOPOLOGY Feature for Enhanced Diagnostics
- SmartLink VCI - Adds CanFD, DoIP, J2534, RP1210
- Codes/Data/Bi-Directional/Special Functions/Coding/Programming



#### Phoenix Max Diagnostic System

SKU **1331492**  
TPDPXMAX **4,499<sup>99</sup>**

- Includes A 4-Channel Oscilloscope
- Supports Cloud-Based Programming For 9+ Brands, Including: Mercedes-Benz, BMW, Audi, Volkswagen/Skoda/Seat, Porsche, Jaguar/Land Rover, Nissan, Subaru and Renault
- Supports 9V to 24V Vehicle Models, Configuring Both Passenger Cars and Heavy Trucks
- Heavy Duty Housing with IP65 Standards
- Auto VIN Technology Automatically Uses the Right Diagnostic Software After Identifying the Vehicle Through its VIN



#### UltraDiag 2-in-1 Diagnostic Scanner and Key Programmer

SKU **1368629**  
TPDULTRADIAG **699<sup>99</sup>**

- Full-System Diagnostics
- 8 Reset Functions: Oil, Throttle Adaptation, EPB, Steering Angle, DPF Regeneration, ABS Bleeding, BMS and Airbag
- Key Programming Functions: Number of Keys, PIN Reading, Key Learning, Remote Control Learning, Delete Keys and All Keys Lost



#### Transponder and Remote Tester Tool

SKU **OUTSIDE BUY/EPO**  
TPDT-DARTS **41<sup>99</sup>**

- Allows Either USB or Battery Powered Function
- Supports Transponder Chips
- Supports 100+ Transponder Chips
- Includes: Quick Guide and a USB Type-C Cable



#### 5" Thermal Imaging Camera Tablet

SKU **OUTSIDE BUY/EPO**  
TPDTC003 **499<sup>99</sup>**

- Superior Image Quality with an IR Resolution of 256 x 192
- Highly Accurate Temperature Readings
- Expanded Capabilities with OTG Functionality
- Optimized Testing Range



TEXA

### Axone Light Car Diagnostic Kit (NANO)

SKU OUTSIDE BUY/EPO **3,699<sup>99</sup>**  
TEXAXLTAKN

The Navigator NANO S can perform diagnostic operations on all major brands of cars and light commercial vehicles. It is the perfect entry level scan tool for automotive repair shops.

- Axone Nemo Light Rugged Tablet
- Navigator NANO S VCI
- IDC5m Car Software License
- Rugged Carrying Case with Custom Foam
- Motor TruSpeed Repair included

**NEW**



### Axone Light Car Diagnostic Kit (Multihub)

SKU OUTSIDE BUY/EPO **4,999<sup>99</sup>**  
TEXAXLTAKMH

The TXT MULTIHUB is TEXA'S flagship scan tool. It is IP53 Certified, can handle Doip, Can-FD, J2534/RP1210 protocols and more. Perfect for advanced diagnostics and shops that want the capability to work in more than one environment from the same device.

- Axone Nemo Light Rugged Tablet
- Navigator TXT Multihub
- IDC5m Car Software License
- Rugged Carrying Case with Custom Foam
- Motor TruSpeed Repair included

**NEW**



TruSpeed Repair



### Both packages offer a complete diagnostics solution:

Access repair information (including torque specs, torque sequences, fluid type, capacities), read and clear codes, view live data, wiring diagrams, maintenance resets, adaptation value resets (engine, brake systems, transmission), cylinder tests, idle learning and much more.

### WHY TEXA?

- Lifetime equipment warranty with active software subscription.
- Built by TEXA to the highest Tier 1 OEM standards.
- Secure Windows-based architecture, not Android.
- With TEXA, YOU own your data.
- Need help? You can rely on TEXA's U.S. based support team to be responsive and knowledgeable.

Try us! Call to set up a demo.

For Outside Buy/EPO, Call 901-300-4878

## ALIGNMENT WITHOUT LIMITS

DIAGNOSTICS + DIGITAL INSPECTION + ALIGNMENT + ADAS CALIBRATION

### MaxiSYS® IA900WAT Intelligent Wheel Alignment with MSULTRA Tablet

- SKU 1281937 Part #IA900WAT
- Intelligent 4-Wheel Alignment System
  - AutoVIN with Pre-Scan Health Check
  - Alignment spec coverage from 1979 to current

- Cameras automatically track vehicle height on lift
- Includes 24" touchscreen display and MSULTRA tablet
- Optional step by step guidance increasing workflow efficiency
- Illustrated alignment instructions, live readings, required tools, & adjustment locations

- Integrates with TPMS and tire tread depth tools
- Add-on LDW and All Systems ADAS Packages available

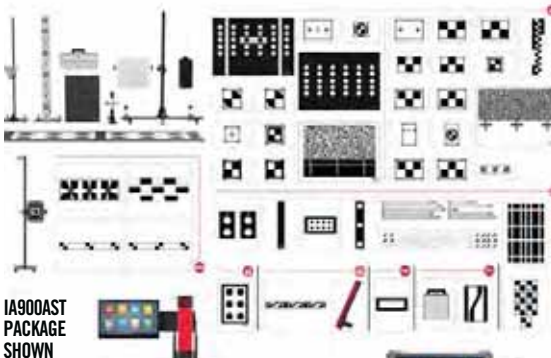

IA900AST PACKAGE SHOWN

### MaxiSYS® ADAS IA900WA with LDW Targets and MSULTRAADAS Tablet

- SKU 1337324 Part #IA900LDWT
- Frame capable of performing 4-Wheel alignment & ADAS calibration
  - Includes ADAS Lane Departure Warning camera calibration targets
  - Includes MaxiSYS ULTRAADAS wireless touchscreen tablet with Alignment and ADAS Calibration software
  - Illustrated alignment instructions, live readings, required tools and adjustment locations display on a single screen

### MaxiSYS® ADAS IA900WA with All Systems Targets and MSULTRAADAS Tablet

- SKU 1268177 Part #IA900AST
- Includes same features & functions as IA900LDWT plus...
- Includes LDW, AVM, NVS, ACC, BSD, LIDAR, and RCW targets/calibration components

### MaxiSYS® IA700 Modular ADAS Calibration Frame With Wheel Alignment pre-Check And Optical Positioning

- SKU 1484478 Part #IA700T
- Includes a MaxiSYS 909, an advanced diagnostics tablet with a wireless VCI and J2534 pass-thru device that supports the latest vehicle protocols, and an ADAS calibration software upgrade card for static and dynamic ADAS calibration coverage for most U.S., Asian, and European ADAS-equipped vehicles.
  - Frame features robotic crossbar and six-high definition positioning and tracking cameras for optical target positioning and prompting unlevel floor compensation.
  - Frame disassembles quickly for easy transport or space-saving storage.
  - Includes four tire clamps with camera targets, a steering wheel lock, brake chocks, power supply, alignment aid, and frame cover.

### MaxiSYS® IA700 Lane Departure Warning Package

- SKU 1484479 Part #IA700LDWT
- IA700T PACKAGE SHOWN
- Same features & functions as IA700T plus...
- Includes Lane Departure Warning patterns and targets for calibration of Mercedes-Benz, Nissan, Infiniti, Hyundai, Kia, Toyota, Lexus, Mazda, Mitsubishi, Subaru, Volkswagen, Audi, and Alfa Romeo camera-equipped vehicles



CALL FOR PRICE

AUTEL®

# DIAGNOSTICS

## Smoke Leak Detectors

### Evap Diagnostic Smoke Machine

SKU **OUTSIDE BUY/EPO** **929<sup>99</sup>**  
MSC43060EV

- Multiple Options for Smoke Injection Include Built-In Internal Compressor, Shop Air and Inert Gases
- Pressure Decay Gauge 0-30" H2O (70 mbar)
- Flow Meter: 0 to 0.040" (0 to 1.0 mm)
- Input Pressure: Max. 100 psi (8.2 bar)
- Built-In Pressure Regulated at 0.5 psi



For Outside Buy/EPO, Call 901-300-4878

### Digital Dual Smoke Machine

SKU **OUTSIDE BUY/EPO** **1,449<sup>99</sup>**  
MSC43066

- High-Precision Gas Pressure Sensor Ensures Accurate Data
- 3 Built-In High-Power Air Pumps, Offers Faster and Thicker Smoke Generation
- Pressure Regulated at 0.44-0.5 psi for Safe EVAP Testing, Maximum Out 20 psi for High Pressure Testing
- Accessories Include: Full Set of Block Off Caps, Schrader Valve Remover/Installer, Service Port Adapter Hose, 2 Oz. Smoke Producing Fluid and Bladder for Intake Testing



For Outside Buy/EPO, Call 901-300-4878



## Reprogrammers

### Smart Battery Charger/Power Supply

SKU **1414398** **699<sup>99</sup>**  
TPDT90000

- ECU Programming Power Supply
- 9 Step Smart Charging with Thermal Compensation
- Charges 12V and 24V AGM, WET, GEL, MF, CAL and EFB Batteries
- Protects Against Reverse Polarities, Reverse Charges, Short Circuits, Overheating and Over-Voltages
- Current Range: 5-90 and 5-45A
- Voltage Range: 11-15.8V and 22-31.5V
- Cables: AWG18-70"



**BONUS VALUE: \$99.99**

### Tornado90000 9.5' DC Cable Extension

TPDT90DC With Purchase of: TPDT90000

Offer Good While Supplies Last Through March 31, 2025



### Programmer and Power Supply Bundle

SKU **OUTSIDE BUY/EPO**  
TPDRLINKBNDL

**Simplify Your Diagnostic Process and Elevate Your Capabilities**

- Highly Compatible with OE-Level Diagnostic Software for Performing Diagnostic, Programming and Coding Tasks
- One-Click Installation of OE-Level Diagnostic Software Drivers and Online Upgrades
- ECU Programming Voltage Stabilizer
- Suitable for All Types of 12V and 24V Lead-Acid Batteries, with a Wide Battery Capacity Range from 5 to 90 Amps
- Includes: T90000 Smart Battery Charger/Power Supply, T90DC Tornado90000 9.5' DC Cable Extension and RLINKLITE J2534 Compliant Passthrough Programming Device



### TOPDON®



**1,399<sup>99</sup>**  
REG. \$1,749.97

**SAVE \$349 OVER**  
When You Buy the Kit

For Outside Buy/EPO, Call 901-300-4878

# POWERED BY AUTEL® DIAGNOSTICS

## MaxiSYS® DIAGNOSTIC SOLUTIONS

- Most comprehensive vehicle coverage in aftermarket scan tool
- Dynamic topology module mapping for supported vehicles
- Octacore processor and 128GB-256GB memory
- Advanced VCMI including 4-channel scope on MSULTRA and MS919
- Programming and flashing with included J2534 pass-through box (with OE subscription)
- Remote Expert allows for remote programming, flashing, and reporting capabilities



### MaxiSYS® MSULTRA

SKU 1092018 Part #MSULTRA

### MaxiSYS® MS919

SKU 1093326 Part #MS919

### MaxiSYS® MS909

SKU 1094086 Part #MS909

### MaxiSYS® ULTRAEV

SKU 1267097 Part #MSULTRAEV

### MaxiSYS® MS909EV

SKU 1267098 Part #MS909EV

	ULTRA	MS919	MS909	MS909EV	ULTRAEV
<b>REMOTE EXPERT ACCESS AND REPORT STORAGE</b>	•	•	•	•	•
<b>PROGRAMMING/FLASHING WITH OE SUBSCRIPTION OR REMOTE EXPERT</b>	•	•	•	•	•
<b>COLOR CODED MODULE TOPOLOGY ON SUPPORTED VEHICLES</b>	•	•	•	•	•
<b>VCMI 5-IN-ONE DEVICE VCI, OSCILLOSCOPE, MULTIMETER WAVEFORM GENERATOR, CAN BUS CHECK</b>	•	•	•	•	•
<b>SPLIT SCREEN FUNCTION</b>	•				•



### MaxiSYS® MS909CV

SKU 1174556 Part #MS909CV

- For Class 1-8 Commercial Vehicles
- Topology Mapping on Select Models
- Engine Coverage for Construction & Agricultural Vehicles



### MaxiSYS® MS906PRO

SKU 119462 Part #MS906PRO

- All system scan with ADAS identification
- Customizable Pre & Post scans
- Bi-directional Control Capability
- ADAS Calibration-capable (additional purchase required)



### MaxiCheck® MX900

SKU 1369200 Part #MX900

- Read & Erase Codes
- Bidirectional Active Tests and Special Functions
- 40+ Function Service Menu

### MaxiIM® IM608PROIIPKA

SKU 1336440

Part #IM608PROIIPKA

- IMMO and Key Programming Bundle
- Program IMMO & Keys for U.S., Asian & European Vehicles
- IM608PROII Tablet, XP400Pro, Wireless JVCI, IMKPA Key Programming Adapter Kit



### MaxiIM® IM508S

SKU 1442228 Part #IM508S

- Fast and Portable IMMO & Key Programming Tablet
- Includes the XP200 Key Programmer

### MaxiIM® KM100

SKU 1242003 Part #KM100

- Advanced key and IMMO 5.5-in. touchscreen tablet with 2 IKEYS
- Program Autel's IKEY universal keys as smart key replacement for 3,000+ vehicles
- One-minute Key generation, Easy key button customization



### MaxiVIDE0® MV480

SKU 1137680 Part #MV480

- Record/Playback Images & Videos
- 4.1" Color LCD Display
- Dual Front and Side Cameras for Wider Viewing Angle

### MaxiVIDE0® MV460

SKU 1089243 Part #MV460

- 3.5" Color LCD Display

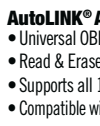

### AutoLINK® AL549

SKU 789375 Part #AL549

- Universal OBD II and ABS Code Reader
- Read & Erase Codes, View Freeze Frame and Live Data
- Supports all 10 Modes of OBD II
- Compatible with U.S., Asian, and European vehicles, 1996 & Newer

**NEW**



### AutoLINK® AP2500

SKU 141288 Part #AP2500

- Read/erase codes, view Freeze Frame & Live Data, perform Emissions test
- Includes Bluetooth dongle for vehicle connection. Download FREE MaxiAP Diag app
- Vehicle health check includes engine oil life, average fuel consumption, and brake pad life.
- All Systems diagnostics on first vehicle brand. Additional coverage can be added with in-APP purchase.

### AutoLINK® AL329

SKU 103946 Part #AL329

- Read/Erase Engine DTCs
- One-Touch I/M Readiness /LED Indicator
- Display Live & Freeze Frame Data

**CALL FOR PRICE**

**AUTEL®**

Prices subject to change without notice. Prices do not include applicable taxes, vehicles, tires, rims, installation or optional equipment as shown. Please do not return purchases to the store. For information regarding warranty, repair, or any questions or concerns, call 901-300-4878.



## Smoke Leak Detectors

### ReadySmoke™ Leak Detector

SKU **OUTSIDE BUY/EPO** **749<sup>99</sup>**  
RED95-0400

- Pinpoint Intake, Exhaust and Other EVAP Leaks In Minutes
- Flow Meter Identifies Minute Leaks at and Below .010" in Diameter
- Easy Fill Dipstick Style Fluid Port
- Includes: (2) 2 Oz. OEM-Approved Vapor Producing Fluid, EVAP Service Tool Kit, Halogen Inspection Light, Cap Plug Kit, Standard Cone Adapter and Storage Case



For Outside Buy/EPO, Call 901-300-4878

REDLINE DETECTION.COM



### Smoke Pro Air™

SKU 1340239 **1,399<sup>99</sup>**  
RED95-0075

- Ideal for Performing Diagnostics on the Evap Systems of Naturally-Aspirated Vehicles
- Features an Onboard Micro Air Compressor for Total Portability and Includes All Needed Accessories
- Uses OEM-Approved Fluid to Produce a Visual Vapor That is Free of Dyes and Contaminants
- Detects Leaks as Small as 0.010" and Performs Air Leak Decay Test



REDLINE DETECTION.COM



### Smoke Pro® Total-Tech®

SKU **OUTSIDE BUY/EPO** **1,099<sup>99</sup>**  
RED95-0003C

- Find ALL Types of Leaks
- Greatly Reduce Diagnostic Time
- One Simple Connection Diagnoses an Entire System in Seconds
- Eliminate Comebacks by Verifying That Leaks are Completely Repaired
- Includes Easy INTAKE™



Warranty: 2 Years  
For Outside Buy/EPO,  
Call 901-300-4878

REDLINE DETECTION.COM

### Intake Inflatable Block Off Bladder

SKU 598274 **69<sup>99</sup>**  
24536

- Conforms to Any Shape
- Intake/Exhaust: Square, Round, Oval or Rectangular
- Works with Most Automobiles and Light, Medium and Heavy Duty Trucks
- Replacement Bladder Available

OEM TOOLS®



Use with All Smoke Machines

### EasyConnect® Test Kit

SKU 1189091 **109<sup>99</sup>**  
RED96-0190

- Forms a Complete Seal for Effective Leak Testing without Disturbing Other Components
- Comes in a Compact and Durable Storage Case
- Compatible with Any Smoke Machine
- Includes: 4 Different Sized Adapters with 4 Add-On Components



REDLINE DETECTION.COM

### Easy INTAKE™

SKU 696477 **169<sup>99</sup>**  
RED95-0082

- Compatible with Any Smoke Machine
- Block Off Bladder Conforms to Any Shape Intake/Exhaust



REDLINE DETECTION.COM



### Smoke Producing Fluid (8 Oz.)

SKU 802333 **29<sup>99</sup>**  
RED96-0039

- Contains No Dye or Other Contaminants
- Works in Most EVAP Smoke Machines



REDLINE DETECTION.COM



### EasyEVAP™ Universal Filler Neck Connector

SKU 343405 **124<sup>99</sup>**  
RED95-0030

- Compatible with Any Smoke Machine and Removes Cleanly from the Gas Cap
- Essential Tool for Late Model Cars with Fuel Tank Rollover Valves



REDLINE DETECTION.COM



## SHARED SERVICE FUNCTIONS

Oil Reset  
EPB - Electronic Parking Brake  
BMS - Battery Management System  
SAS - Steering Angle Sensor  
Immo Keys - Immobilizer & Keys  
Brake Bleed  
DPF - Diesel Particulate Filter  
Injector  
Suspension  
Throttle  
ABS/SRS  
VGT Learn  
Relative Compression  
Window / Door / Roof  
Seats  
Odometer

Language Change  
Headlamp  
CHG Tire Size  
Speed & PTO  
Cylinder  
Trans Adaption  
Airbag Reset  
Clutch  
A/F Setting  
Resolver Sensor Calibration  
Automatic Start/Stop  
Electronic Water Pump Start  
EGR

FRM Reset  
Transport Mode  
HV Battery  
ACC  
A/C  
Rain/Light Sensor  
Reset Control Unit  
CCS/ACC  
VIN  
Coolant/Refrigerant Change  
Sunroof Initialization  
TEC learn  
HV De-energization/Energization  
All System Auto-Scan

MaxiCheck® MX900  
SKU 1369200 Part #MX900



MaxiTPMS® TS900  
SKU 1337325 Part #TS900



CALL FOR PRICE

	MAXICHECK MX900	MAXITPMS TS900
OPERATING SYSTEM	ANDROID 11	ANDROID 11
SOFTWARE UPDATES	1 YEAR FREE	1 YEAR FREE
AUTOMATIC DETECTIONS	AUTO-VIN/SCANVIN	AUTO-VIN/SCANVIN
VEHICLE COVERAGE	US, ASIAN & EUROPEAN 1996 & NEW	US, ASIAN & EUROPEAN 1996 & NEW
OBDII TEST MODES	PERFORM BI-DIRECTIONAL ACTIVE TESTS AND SPECIAL FUNCTIONS	PERFORM BI-DIRECTIONAL ACTIVE TESTS AND SPECIAL FUNCTIONS
DIAGNOSTICS & SERVICE	ALL SYSTEMS / 40+ SERVICES	ALL SYSTEMS / 40+ SERVICES
VEHICLE CONNECTIVITY	CORDED	BLUETOOTH VCI
TPMS DIAGNOSTICS	-	INCLUDED WITH ENHANCED TPMS STATUS SCREEN
TPMS SENSOR COMPATIBILITY	-	AUTEL BLE SENSOR FOR TESLA + PROGRAM AUTEL MX-SENSOR 1-SENSORS

AUTEL®

# DIAGNOSTICS

## Multimeters and Test Kits

### Power Probe III Professional Electrical Test Kit

SKU 1330691  
PWPPP3KIT01 **339<sup>99</sup>**

- Supplies Power and Ground for Functional Component Testing
- CAT-IV 600V Hybrid Safe AC/DC Voltmeter
- Measures Resistance to 60M Ohms
- Measures Current from .001 Amps to 10 Amps



**BONUS VALUE: \$84.99**

### High Power Butane Torch

PWPPPBT

With Purchase of: PWPPP3KIT01  
Offer Good While Supplies Last Through March 31, 2025



POWER PROBE

### Power Probe III Circuit Tester

SKU OUTSIDE BUY/EPO  
PWPPP3CSRED **149<sup>99</sup>**

- Digital Voltmeter
- Continuity Tester
- 20' Jumper Lead Set
- Relay and Component Tester
- Removable Probe Tip Adapts to Any 4 mm Lead
- 2 Bright LED Lamps
- Quickly Supply Power and Ground to the Tip

POWER PROBE



For Outside Buy/EPO,  
Call 901-300-4878

### Power Probe III with Case and Accessories

SKU 262523  
PWPPP319FTC **189<sup>99</sup>**

- Relay and Component Tester
- Voltmeter and Continuity Tester
- Carbon Fiber Design Housing
- Audio Tone
- 20' Jumper Lead
- Works on 12V to 24V Sources

POWER PROBE

Other Colors Available on  
[AZTOOL1.com](http://AZTOOL1.com)



### 3EZ Kit with Case and Accessories

SKU OUTSIDE BUY/EPO  
PWPPP3EZREDAS **229<sup>99</sup>**

- Menu Driven Screen Makes Navigating a Breeze for Easier Diagnosing of Electrical Issues
- All-in-One Tool with DC Voltmeter, Min, Max, and Peak-to-Peak Mode, Along with Audio Signal Capability (AC Threshold)
- 8 Amp Thermal Circuit Breaker Provides Protection While Powering Up Components, Relays or Circuits and Still Allowing Inrush Current for Larger Draw Components

POWER PROBE



For Outside Buy/EPO,  
Call 901-300-4878

### Power Probe III with Lead Set

SKU 1330690  
PWPPP3LS01 **269<sup>99</sup>**

- Supplies Power and Ground
- Digital Voltmeter with Min./Max. Voltage Capturing
- 4 mm Banana Jack
- 20 Ft. Power Lead

POWER PROBE



### Power Probe IV with Case and Accessories

SKU 802331  
PWPPP401AS **309<sup>99</sup>**

- Supplies Power and Ground for Functional Component Testing
- Digital Volt and Ohmmeter for Circuit Testing
- Large Color LCD Screen with Easy to Navigate User Menu
- AC-RMS, AC Peak-to-Peak, Frequency and Pulse Width for Signal Testing
- Fuel Injector Tester for Easy Circuit Diagnosis
- PCM/ECM Driver Supplies Safe Voltage for Testing Circuits

POWER PROBE



### Power Probe® III Master Combo Kit

SKU 1105994  
PWPPPKIT03S **429<sup>99</sup>**

- Power-Up Components
- Audible Monitoring of Electrical Signals Voltmeter
- 12V to 24V Range
- Bad Ground Indicator
- Continuity Tester
- Relay and Component Tester
- Trace Short and Open Circuits

POWER PROBE



### Power Probe IV Master Kit

SKU 1330692  
PWPPPKIT04 **499<sup>99</sup>**

- Supply Power or Ground for Functional Component Testing
- Self-Resetting Thermal 8 Amp Circuit Breaker
- Multiple DC Volt Readings on the Same Display
- Quickly Determine if the Circuit is Open or is Shorted

POWER PROBE



### Automotive Test Lead Kit

SKU 1105993  
ESI143 **59<sup>99</sup>**

- Includes: Flexible Silicon Back Probe Pins - Great for Back Probing, Test Probes, Crocodile Clips, Shielded Alligator Clips
- One Set of Interconnect Leads - Extended Test Lead Length of 64"
- Roll Up Storage Pouch to Keep Your Leads Organized

ES



### Auto-Ranging Digital Multimeter

SKU 851885  
ESI480A **69<sup>99</sup>**

- 43 Test Ranges, Auto-Ranging
- 10 Test Functions
- Auto Power-Off, Data Hold
- Dual Fuse Protection
- 10 Meg/Ohm Input Impedance

ES



## Diagnostic

### Compression Tester Gauge Set

SKU 1103601 **29<sup>99</sup>**  
37138

- Use to Test Compression 0 to 300 psi on 14 mm and 18 mm Spark Plug Ports and Determine Engine Mechanical Condition



### 8 Piece Noid Light Set

SKU 1103589 **24<sup>99</sup>**  
37161

- Includes: GM TBI, GM SCPI, GM PFI, Ford TBI, GEO TBI, Bosch PFI, Bosch Type 2 and GM Multec 2
- See-Through Design to Check Electrical Pulses



### Automotive Tune-Up and Brake Bleed Kit

**OEM TOOLS**

SKU 70116 **36<sup>99</sup>**  
25136

- Easily Diagnose Vacuum and Pressure Related Systems from the EGR to Brake Bleeding to Cooling Systems on Today's Complex Vehicles
- Kit Contains Our Most Popular Hand Vacuum Pump with Vacuum Gauge and Accessories



### Exhaust Back Pressure Tester/Gauge

SKU 1103604 **54<sup>99</sup>**  
37263

- Oxygen Sensor Adapter is M12 and M18 Thread
- 6' Hose Allows User to Test from Driver's Seat
- Test for Restricted Exhaust Systems



### Oil Pressure Gauge Set

SKU 347229 **105<sup>99</sup>**  
27262

- For Use on Diesel and Gasoline Engines
- Includes Standard and Metric Adapters Found on Most Cars and Trucks
- 2-1/2" Easy-to-Read Gauge with Protective Boot
- Range: 0-100 psi, 0 to 7 Bar



## SUR&R®

### S-Hook Sprayer

SKU 1149152 **69<sup>99</sup>**  
SURS-TOOL

- Nozzle End Produces Fine Mist Spraying Action for Thorough Cleaning of the Air Intake
- Helps Improve Fuel Performance
- Removes Carbon Build-Up
- For Use with SURFIC203

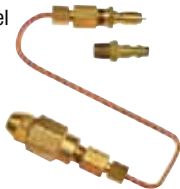

### Fuel Injection Cleaner Kit

SKU 1137808 **419<sup>99</sup>**  
SURFIC203



- Provides Powerful, Thorough Cleaning of Fuel Injectors, Intake Valves and Fuel Passages
- Makes Connections Quickly and Easily Using S.U.R.&R.'s Exclusive Quick Connects
- Holds Up to 18 Oz. of Canister Cleaning Solution
- Cleans More Thoroughly Than Aerosol Methods
- Easy to Connect and Use with Shop Air
- For Top Engine and Throttle Body Cleaning



## Timing Light



### Digital Tach Advance Timing Light

SKU 666346 **129<sup>99</sup>**  
ESI125

- Measures Ignition Spark Advance from 0° to 90°
- 2 and 4 Stroke Tachometer Measures Engine Speed Up to 9,999 RPM
- Accurate Up to 9,000 RPM
- Works with 12 Volt Electrical Systems



## LANG

### TU-113PB Fuel Injection Pressure Tester

SKU 1330689 **89<sup>99</sup>**  
LNGTU-113PB

- Works on Most Domestic and Import Vehicles



### TU-550 Master Fuel Injection Pressure Tester



SKU 1330693 **659<sup>99</sup>**  
LNGTU-550

- Covers All Domestic and Foreign Platforms 1988 to Present
- Does Not Include Cis and TBI Adapters



### TU-24A-PB Three Way Exhaust and Back Pressure Kit

SKU 1331498 **179<sup>99</sup>**  
LNGTU-24A-PB

- Allows Quicker and Accurate Testing for Blockages in Catalytic Converters, Mufflers, etc.
- Test in 3 Different Access Points: Oxygen Sensor, Exhaust Pipes and Air Injection System



## Fuel System Cleaners



### Carbon Clean 1000

SKU OUTSIDE BUY/EPO **1,959<sup>99</sup>**  
MVC500-0220

- Complete, Through the Rail, Fuel System Decarbonizing Service
- Fuel Rail Hookup Provides the Most Effective Results
- Online Application Guide
- Unique Time Saving Adapter System
- Cleans Fuel Injectors, Combustion Chamber and Intake Valves
- Works with MV5 (400-0050) Fuel System Cleaner

### MV5 Press Gas/Petrol Fuel System Cleaner 17 Oz. (6 Pk.)

SKU OUTSIDE BUY/EPO **139<sup>99</sup>**  
MVC400-0050PK6



For Outside Buy/EPO, Call 901-300-4878

# DIAGNOSTICS

**Mityvac®**

## Professional Compression Test Kit

SKU 972276 **109<sup>99</sup>**  
MITMV5530

Everything You Need to Perform Cylinder Compression Tests on Motorcycles, Marine and Small Engines and an Air-Hold Adapter for Performing Valve Seal Repairs

- Adapters Include: 10 mm, 12 mm, 14 mm and 18 mm
- Extended Hoses for Hard-to-Reach Cylinders
- Large 2-3/4" Easy-to-Read Gauge
- Quick Disconnect Fittings



## Digital Gas Engine Compression Test Kit

SKU 383182 **209<sup>99</sup>**  
MITMV5532

- Stores Maximum Compression Value for Up to 12 Cylinders
- 3 Minute Auto Shut-Off
- Sealed, Grease and Oil-Resistant Gauge Face Prevents Contamination of Electronics
- Displays Values in psi, Bar and kPa



## Fuel Pressure Test Kit

SKU 988887 **669<sup>99</sup>**  
MITMV5546

Tests Fuel System Pressure to Diagnose Common Fuel System Problems Including Failing Fuel Pump, Faulty Pressure Regulator, Blocked Filter(s) and Pinched Fuel Line(s)

- Contains 37 Adapters for Pressure Testing Most Vehicles
- High Quality, Heavy Duty Gauge with 0 - 120 psi
- Easily Upgrades to a Fuel Pressure and Flow Tester with the Addition of Flow Meter Upgrade Kit MVA5553



**mityvac**

## Ford 6 Liter Adapter

SKU 972279 **74<sup>99</sup>**  
MITMVA5610

- Glow Plug Adapter - M14 x 1.25
- International VT365
- Ford Power Stroke, 6.0 Liter Engine



## Silverline Elite Test Kit

SKU 988888 **139<sup>99</sup>**  
MITMV8500

- Provides Either Vacuum or Pressure with Equal Precision and Convenience
- Performs Engine Performance Diagnostics, Brake Bleeding, Fluid Transfer, Evacuation, Sampling and More
- Includes Components Needed to Perform Hundreds of Diagnostic and Mechanical Tests



## Fuel Injection Cleaning Kit

SKU 972277 **289<sup>99</sup>**  
MITMV5565

- Cleans Air Induction Systems Functions on Most Foreign and Domestic Applications
- Uses Shop Air
- Quickly and Cleanly Removes Deposits from Injectors
- Carbon Deposits in the Intake Manifold and on Intake Valves
- Accessory for the MITMV5546 and MITMV5545



**INNOVA**

**OE-LEVEL DIAGNOSTIC TOOLS**

**US-BASED SUPPORT**

## SDS-Pro

Contact commercial sales manager for pricing.

INNOVA® 7111  
SKU#1062521

- FREE access to RSPRO built-in
- Secure Gateway (SGW) access on 2018 & newer FCA vehicles

STORE STOCKED

- OEM/Enhanced Diagnostics
- Active Tests and Special Functions
- Removeable VCI - Wireless Diagnostics



POWERED BY REPAIR SOLUTIONS PRO  
Automotive repair database with verified fixes and repair tips.

## SDS-Tech

Contact commercial sales manager for pricing.

INNOVA® SDS50  
SKU#1269649

- FREE access to RepairSolutionsPRO
- All Systems Scan
- Service Check and Warning Light

STORE STOCKED

- OEM Level DTCs + Live Data
- Active Tests and Special Functions



POWERED BY REPAIR SOLUTIONS PRO  
Automotive repair database with verified fixes and repair tips.

## SDS-Inspector

Contact commercial sales manager for pricing.

INNOVA® SDS43  
SKU#1269650

- FREE access to RepairSolutionsPRO
- Multiple Report Types
- Service Check and Warning Light

STORE STOCKED

- Bi-Directional / Active Tests + Special Functions
- OEM Level DTCs + Live Data



POWERED BY REPAIR SOLUTIONS PRO  
Automotive repair database with verified fixes and repair tips.

POWERED BY REPAIR SOLUTIONS PRO



Designed for professional technicians to simplify and augment their vehicle diagnostic process.

- Verified Fixes
- Repair Tips
- Technical Services Bulletins (TSBs)
- Parts/Tools for Repair
- Scheduled Maintenance
- Predictive Repairs

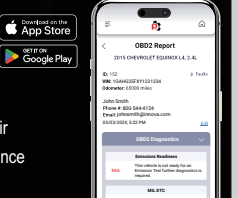

## INNOVA® INFRARED THERMAL IMAGING CAMERA

Contact commercial sales manager for pricing.

3361  
SKU#1407324

STORE STOCKED

- Target & record temperatures and thermal data with advanced infrared technology
- Easily inspect vehicle cooling systems, HVAC, brakes and more
- Built-in flashlight and laser



## INNOVA® 2.8" LCD INSPECTION CAMERA

Contact commercial sales manager for pricing.

3381  
SKU#1392578

STORE STOCKED

- Record video and audio
- 8 Bright Illumination LEDs fully light up the inspection area
- IP67 Rated Submersible Lens allows safe inspection of areas contaminated by oil or water



Accessories Included: Magnet, Hook and Mirror

## INNOVA® COMPRESSION TESTER PLUS

Contact commercial sales manager for pricing.

3614  
SKU#273351

STORE STOCKED

- Universal direct shaft
- 15" high-pressure S.S. hose with 14mm & 18mm fittings
- Side-release valve
- Large, 2-1/2" dial face
- 10mm, 12mm and 14mm long reach adaptors



## INNOVA® AUTOMOTIVE DIGITAL MULTIMETER

Contact commercial sales manager for pricing.

3340  
SKU#94874

STORE STOCKED

- Tests alternators, diodes, solenoids, breaker points, wiring, switches and more
- 10 MegOhm impedance prevents damage to ECU
- Measure RPM, Dwell, Frequency, Temperature, Pulse Width, Duty Cycle
- Accessories Included



## Fluid Extractors

Change fluids quickly and easily anytime. No mess, no clean up. Simply remove the dipstick and insert the tube.



All OEMTOOLS Fluid Extractors Include:

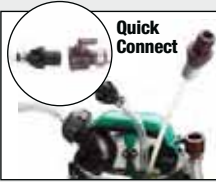

Quick Connect



Automatic Shut Off Valve Prevents Overfilling



No Leaks - Solid One-Piece Tank

- Single Piece Reservoir Structure Features a Leak Proof Bottom
- Overflow Shut Off Valve Prevents Fluid from Overflowing
- Use to Extract Most Fluid Types: Engine Oil, Transmission Fluid, Gear Oil, Coolant and Power Steering Fluid
- Updated 41" Extended Dipstick Hose Adapter for Longer Reach and Broader Applications



Manual Function

### Manual Fluid Extractors

- Reservoir with Hand Operated Pump to Tackle Big Jobs



Pneumatic or Manual Function

### Pneumatic/Manual Fluid Extractors

- Working psi: 85; Max. psi: 120
- Air Consumption: 6.5 CFM



**2.1 Gallons (8.4 Qts.)**  
SKU 666877  
24936  
**99<sup>99</sup>**



**2.5 Gallons (10 Qts.)**  
SKU 547010  
24397  
**109<sup>99</sup>**



**1.5 Gallon (6.3 Qts.)**  
SKU 666978  
24937  
**89<sup>99</sup>**



**2.5 Gallon (10 Qts.)**  
SKU 666881  
24938  
**119<sup>99</sup>**

### Brake Bleeder Adapter Hose for Fluid Evacuators

SKU 568479  
24446 **17<sup>99</sup>**

- Use with OEMTOOLS Fluid Evacuators, Converting Them into One-Person Vacuum Brake or Hydraulic Clutch Bleeders
- Universal Bleed Screw Adapter

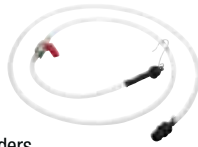

### Main Suction Hose Replacement

SKU 1442592  
24938-1 **44<sup>99</sup>**

- Replacement for OEMTOOLS 24938, 24937, 24397, 24389 and 24936



### Replacement Dipstick and Tube Adapters

SKU 1442595  
24938-2 **29<sup>99</sup>**

- 1/4" x 17" PVC Hose



SKU 1442583  
24938-3 **39<sup>99</sup>**

- 1/4" x 41" Nylon Hose



## Fluid Evacuators

### PneumatiVac Fluid Evacuator (2.3 Gallon)

SKU 497203  
MITMV7300 **169<sup>99</sup>**

- Operates on Compressed Air
- Independent Air Shut-Off Valve



### Fluid Evacuator Plus

SKU 497200  
MITMV7201 **179<sup>99</sup>**

- Evacuates or Dispenses at the Push of a Button
- Integrated 2.3 Gallon (8.8 Liter) Capacity Reservoir
- Durable, Chemical Resistant Polyethylene Construction
- Dipstick Tube Adapters Included



### Fluid Evacuator (1.9 Gallon)

SKU 594882  
MITMV7400 **139<sup>99</sup>**

- Integrated 1.9 Gallon (7.3 Liter) Capacity Reservoir
- Evacuates All Kinds of Fluids Including Engine Oil, Transmission Fluids, Gear Oil, Coolant, Brake Fluid and More



# FLUID HANDLING

## Fluid Extractors and Fillers

### 1.5 L Fluid Extractor/Dispenser

SKU 606541  
MITMVA6852 **69<sup>99</sup>**

- Simple Manual Syringe-Type Action Quickly and Cleanly Extracts or Dispenses Fluid
- Integrated Valve and Cap to Prevent Spills and Leaks
- Compact, Streamlined Design Allows Access into Tight Spaces
- Ideal for Evacuating or Topping Off Fluid Reservoirs
- Easy to Clean; Hose and Seals are Simple to Replace

Mityvac



### Manual Fluid Extractor and Filler (7 Oz./21 Qt/200 mL)

SKU 666326 **9<sup>99</sup>**  
24985

- Used to Extract and Refill Many Common Automotive Fluids, Including Brake Fluid
- Dual Scale Molded into Cylinder Body (Qt./mL)
- Includes Extension Tube for Accessing Hard-to-Reach Filler Necks and Reservoirs

OEM TOOLS



### 1.5 L Fuel Extraction Syringe

SKU OUTSIDE BUY/EPO  
MITMVA6853 **99<sup>99</sup>**

- Ideal for Evacuating or Priming Diesel Fuel Systems
- 2 Adapter Hoses: 10 mm Male to 3/8" or 5/16" Female Fuel System Connections
- 3 Male-to-Male Adapters: 10 mm Male to a Barbed, 3/8" or 5/16" Male Connection

Mityvac



For Outside Buy/EPO, Call 901-300-4878

### Fluid Siphon Pump

SKU 568475 **29<sup>99</sup>**  
24863

- Transfer Fluids Easily Use to Transfer Gas, Water, Oil and Other Non-Corrosive Liquids
- Hose Reach: 6' with 1/2" Diameter

OEM TOOLS



### Transmission Fluid Fill Adapter

SKU 1125880 **18<sup>99</sup>**  
25740

- Required Tool to Fill or Add Fluid to the 5R55W Automatic Transmission
- Used in Many Ford Vehicles (2003 - Newer) Same as Ford No. 307-437

OEM TOOLS



## Fluid Management

### Manual ATF Filler System

SKU 526508 **99<sup>99</sup>**  
24441

- Complete System for Servicing Sealed Automatic Transmissions
- Includes Adapters to Fit Ford, BMW, Honda, Nissan, VW, Porsche, Mini Cooper, Audi and Mercedes-Benz Transmissions
- Reservoir Capacity: 3 Liters (3.1 Quarts)
- Fluid Dispensing Hose Features a Swivel Connector and Fluid Dispensing Shut-Off Valve
- Comes with Belt Attachment for Storing All of the Adapters on Dispenser
- Adapters Included:
  - DSG M24 x 1.5,
  - CVT M22 x 1.5,
  - CVT M12 x 1.5,
  - ATF M10 x 1.0,
  - ATF 1/8 NPT - 27,
  - ATF 04, ATF 03 and ATF 02

OEM TOOLS



### ATF Refill Kit, 5 L

SKU 265092 **469<sup>99</sup>**  
MITMV6410A

- Fluid is Dispensed Under Pressure for Smooth Continual Flow
- Integrated Manual Pump Adds Air Above the Fluid Level to Prevent Aeration
- Internal Pump Components are Sealed Against Exposure to Fluids
- Flow Control Valve is Conveniently Located Near Fluid Output
- Features Integrated Safety and Manual Pressure Relief Valve

Mityvac



### Universal Fluid Dispensing System

SKU 265093 **239<sup>99</sup>**  
MITMV6400

- Large 1.2 Gallon (5 Liter) Fluid Capacity
- Integrated Manual Pump Adds Air Above the Fluid Level to Prevent Aeration
- Pressure Gauge Indicates Fluid Dispensing Pressure
- Safety and Manual Pressure Relief Valve
- Vehicle Adapters Not Included

Mityvac



### Pneumatic ATF Refill Kit, 10 L

SKU 1330680 **499<sup>99</sup>**  
MITMV7412

- Utilizes Compressed "Shop-Air" to Produce Pressure for Fluid Dispensing

Mityvac



### ATF Refill Adapters with Hose

SKU 1361999 **269<sup>99</sup>**  
MITMV7216A

- Quickly Converts the Mityvac MITMV7201 Fluid Evacuator Plus into a Professional Tool for Refilling Sealed Automatic Transmissions
- 13 Quick-Change ATF Refill Adapters Fit Most Vehicle Transmissions

Mityvac



## Great for Use with Generators

### Battery-Operated Liquid Transfer Pump

SKU 1414413 **26<sup>99</sup>**  
87230

- Move Liquids Safely and Easily with This Convenient Handheld Pump
- Use in Garage, Aquariums, Home and Yard
- Pumps Up to 6 Quarts of Liquid per Minute
- Battery Operated (2 "D" Batteries)

OEM TOOLS



## Lever Action Pumps

**OEM TOOLS**

### Lever Action Hand Oil Pump

SKU 462495 **29<sup>99</sup>**  
24381

- Oil Pump for Use with Oil-Based Fluids, Heating Oils, Motor Oils, Heavy and Light Oils, Diesel and Kerosene
- Built-In 1-1/2" and 2" Bung for Use on 16 to 55 Gallon Drums with Either Opening
- Not for Gasoline or DEF



**OEM TOOLS**

### Lever Action Barrel Pump - Polypropylene

SKU 688036 **39<sup>99</sup>**  
24471

- Lever Action Pump, Self-Priming
- Ideal for Diesel, Kerosene, Lubricants and Other Oils
- Not for Gasoline, Water Based Chemicals or DEF
- Maximum Flow Rate: 12 Oz. per Stroke
- Maximum Viscosity: 40 Wt. Oil



**OEM TOOLS**

### Lever Action Barrel Pump Polypropylene Stainless Steel Rod

SKU 688038 **39<sup>99</sup>**  
24472

- Ideal for Pumping Diesel, Oils, Kerosene, Water-Based Chemicals, Bases and Mild Acids
- Not for Gasoline or DEF



**OEM TOOLS**

### Lever Action Barrel Pump - Ryton® Stainless Steel Rod

SKU 688037 **49<sup>99</sup>**  
24473

- Ideal for Pumping Diesel, Oils, Kerosene, Water-Based Chemicals, Bases and Acids Including DEF
- Not for Gasoline

**DEF COMPATIBLE**



**LINCOLN**

### Lever Action Barrel Pump

SKU 970530 **99<sup>99</sup>**  
LIN1340

- Pumps Non-Corrosive Fluids, Not for Gasoline
- Telescoping Tube for 16 to 55 Gallon Drums
- Removable Non-Drip Spout Allows for Threaded Hose Connection



## Rotary Pumps

**OEM TOOLS**

### Rotary Barrel Pump

SKU 462486 **39<sup>99</sup>**  
24382

- Fluid Transfer Pump for Use with Oil-Based Fluids, Heating Oils, Motor Oils, ATF, Diesel and Kerosene
- Not for Gasoline or DEF



**OEM TOOLS**

### Polypropylene Rotary Drum Pump

SKU 688035 **89<sup>99</sup>**  
24470

- Ideal for Pumping Diesel, Oils, Kerosene, Water-Based Chemicals, Bases and Mild Acids
- Not for Gasoline or DEF



### Manual Rotary Oil Pump with Hose for 55 Gallon Drums

SKU 265089 **329<sup>99</sup>**  
LIN1385H

- Includes: 8 Ft. x 3/4" Anti-Static Hose with Non-Sparking Aluminum Nozzle with Hanger; Seal Tight Telescoping Pick-Up Tube with Strainer for 16 to 55 Gallon Drums with 2" Bung



**LINCOLN**

### Manual Rotary Fuel Pump with Hose for 55 Gallon Drums

SKU 265088 **369<sup>99</sup>**  
LIN1387

- 3 Vane Manual Rotary Pump for Most Fluid Types Including Gasoline, Diesel, Kerosene, Coolant, Non-Corrosive Materials, Medium Viscosity Petroleum Based Fluids, Hydraulic Oils and ATF



**LINCOLN**

### Manual Rotary Pump for 55 Gallon Drums

SKU 462977 **249<sup>99</sup>**  
LIN1385

- Hose Not Included

Drum Not Included

## Drum Wrench

**OEM TOOLS**

### Aluminum Drum Bung Wrench

SKU 1267963 **29<sup>99</sup>**  
22664

- Comfortable and Textured Grip for Ease of Use
- Non-Sparking, Non-Corrosive Aluminum Construction
- Fits Most Steel and Plastic Caps, Including 3/4" Vent Plugs
- Effortlessly Opens and Tightens Bungs to Guarantee Drum Contents are Safe
- Opens 10, 15, 20, 30 and 55 Gallon Barrels



## Fuel Transfer Pump

**JohnDew Industries**

### 25 Gallon Steel Gas Caddy

SKU 360585 **749<sup>99</sup>**  
DOWFC25GC

- UL Approved
- 25 Gallon Tank is Constructed of 14" Gauge Steel for Use with Unleaded Gasoline, Kerosene, Ethanol E85, Diesel and Bio-Diesel Fuels



## DEF Pump

**LINCOLN**

### Lift Action Pump

SKU 1142361 **134<sup>99</sup>**  
LIN1390

- Transfers Popular Shop Fluids Including Acetone, Antifreeze, Windshield Washer, Thinners and More
- Includes NPT and Buttress Threads for Steel and Plastic Drums
- Adjustable Bung Type Fits 15, 16, 30 and 55-Gallon Drums
- Welded Ground-Post for Safe Dispensing of Volatile Fluids
- Premium Grade 316 Stainless Steel
- Self-Priming

**DEF COMPATIBLE**



## Grease Pump

**LINCOLN**

### Manual Gear Lube Dispenser

SKU 174166 **139<sup>99</sup>**  
LIN1293

- 5' Hose, 13" Pump Tube
- Fits 25 to 50 Lb. 5 Gallon Containers
- Delivers 1 Oz. per Stroke



# FLUID HANDLING

## Fluid Exchangers

**MAHLE**

### ATX280 Trans Fluid Exchange Unit

SKU OUTSIDE BUY/EPO MSS4008002300 **5,799<sup>99</sup>**

- 7" Touchscreen LCD Display with Graphical Interface
- Onboard Additive Tank for Detergent/Oil Injection



Fluid Not Included

### Trans-Tech 4 Plus MOTORVAC

SKU OUTSIDE BUY/EPO MVC500-1125B **5,249<sup>99</sup>**

- Automatic, In-Line Exchange Through Vehicle Cooler Line
- ATF Exchange Through Vehicle Transmission Dipstick
- Drain Pan Feature
- 26 Quart New Fluid Reservoir
- High Volume Pump for Rapid and Efficient Service
- Comes with Standard Set of Adapters
- Uses MVC400-0137 2-Part ATF Cleaner and Conditioner Fluid



Fluid Not Included

### BFX-10 Brake Fluid Exchanger

SKU OUTSIDE BUY/EPO MSS4258001600 **1,249<sup>99</sup>**

- Suitable for ABS, ESP, EDS and SBC
- Hydraulic Pump
- Two Universal Adapters Included



**MAHLE**

### BFX-20 Brake Fluid Exchanger

SKU OUTSIDE BUY/EPO MSS4258001400 **2,449<sup>99</sup>**

- Hydraulic Pump
- Suitable for ABS, ESP, EDS and SBC
- Adapters Included



## Lube Tech Set **OEM TOOLS**

SKU 227302 | 24965

**1,699<sup>99</sup>** REG. \$2,516.20

**Includes 160 of the Most Common Tools in Tool Cart**

- SAE and Metric, 1/4", 3/8" Drive Tools, Combination Wrench Sets, Pliers and Screwdrivers. Plus Battery Service Tools, Oil Change Tools and More

**SAVE \$816**



Cart Style and Color May Vary  
Offer Good Through March 31, 2025

To Confirm Price, Availability and Ordering Instructions on Outside Buy/EPO Call 901-300-4878

## Oil and Grease

### Lynx 3:1 Universal Stub Pump

SKU OUTSIDE BUY/EPO BAL1110-007 **414<sup>99</sup>** **NEW**

- Reliable Air Motor Design that Features Corrosion Resistant Materials
- Double-Acting Pump Design for Smooth and Accurate Fluid Delivery
- Includes: 2" Bung-Adapter



### Oil Control Handle with Digital Meter

SKU 1485049 BAL3330-159 **314<sup>99</sup>**

- Exclusive "Memory" Flex Enables the Extension to Bend Into Any Desired Shape
- Replaceable Electronic Circuit Board and Face Plate
- Ergonomically Designed Grip Handle Reduces Fatigue for Technicians



**Balerank**  
Fluid Dispensing Systems

**NEW**

### 50' EVO Reel, Lynx 5:1 HD Pump, 275 Gal

SKU OUTSIDE BUY/EPO BAL1135-017 **3,879<sup>99</sup>**

- Double Wall Construction
- UL 2258 Certified
- Compatible Fluids: DEF, Diesel and Lubricants
- Compact Design
- Package Assembled from Factory



**NEW**

### 5:1 HD Oil Pump Drum Package

SKU OUTSIDE BUY/EPO BAL1131-069 **2,229<sup>99</sup>** **NEW**

- Reliable Air Motor Design that Features Corrosion Resistant Materials
- Includes: Heavy-Duty Drum Cart with Semi-Pneumatic 10" Tires, Front Caster with Brake to Steady Cart While in Use, 50' x 1/2" Hose Reel and Electronic Metered Handle



Drum Not Included

### Lynx 55:1 Pump Package

SKU OUTSIDE BUY/EPO BAL1151-036 **1,249<sup>99</sup>**

- Reliable Air Motor Design that Features Corrosion Resistant Materials
- Double-Acting Pump Design
- Optional Hose Reel Mounting Kit



Drum Not Included

Inside View



# GREASE GUNS

TO ORDER, contact your Commercial Sales Manager or go to [AutoZonePro.com](http://AutoZonePro.com)

GREASE GUNS

## Grease Guns

- Cast Iron Pump Head for Added Strength and Durability
- Multiple Filling Options to Support Suction, Filler and Cartridge Loading
- Precision Fit Plunger Prevents Grease Bypass and Resists Scoring
- Heavy Duty Follower Spring Allows Easy Priming and Efficient Pumping

**OEM TOOLS**



Mini Pistol with Extension	Mini Lever Action	Lever Action Clear	Lever Action	Pistol Grip with 18" Extension Hose	Pneumatic with 18" Extension Hose
SKU <b>1207892</b> 87207	SKU <b>1207896</b> 87206	SKU <b>1207899</b> 87204	SKU <b>1362012</b> 87201	SKU <b>1207888</b> 87203	SKU <b>1207901</b> 87205
<ul style="list-style-type: none"> <li>• Includes 6" Extension</li> <li>• 2,900 Max. psi</li> </ul>	<ul style="list-style-type: none"> <li>• 4,000 Max. psi</li> </ul>	<ul style="list-style-type: none"> <li>• Includes 7" Extension</li> <li>• 10,000 Max. psi</li> </ul>	<ul style="list-style-type: none"> <li>• Includes: 6" Steel Extension</li> <li>• 7,000 Max. psi</li> </ul>	<ul style="list-style-type: none"> <li>• Pistol Grip Handles Supports One Handed Operation</li> <li>• 6,000 Max. psi</li> </ul>	<ul style="list-style-type: none"> <li>• Includes 5.5" Extension</li> <li>• Air Operated for Continuous Lubrication Flow</li> <li>• 6,000 Max. psi</li> </ul>
<b>19<sup>99</sup></b>	<b>19<sup>99</sup></b>	<b>29<sup>99</sup></b> <b>SAVE \$10</b> REG. \$39.99 Offer Good Through March 31, 2025	<b>19<sup>99</sup></b>	<b>34<sup>99</sup></b>	<b>39<sup>99</sup></b>

## Grease Gun Accessories

### 7 Piece Grease Gun Accessory Kit

SKU **978118** **44<sup>99</sup>**  
25711

- Includes: Press-On 90° Lube Tool, Straight Extension, 300 mm Hose Extension, Slide-On 90° Coupler, Rubber Tip Nozzle, Needle Nozzle and 60° Coupler



### Extension Hoses with Spring Guard

- Premium Grease Hoses for Manual and Air-Operated Grease Guns
- Spring Guard for Added Rigidity to Prevent Kinking
- Max. Working Pressure: 4,500 psi
- Burst Pressure: 12,000 psi
- Accessory Thread: 1/8" NPT



**12"** SKU **1207902** **9<sup>99</sup>** **18"** SKU **1207887** **10<sup>99</sup>** **36"** SKU **1207893** **11<sup>99</sup>**  
87220 87221 87222

### 70 Piece Grease Fitting Assortment

SKU **577685**  
25752

**17<sup>99</sup>**

- 70 Assorted Grease Fittings in 6 Popular Sizes



### Bearing Packer

SKU **1055505** **18<sup>99</sup>**  
26540

- Quickly Flushes Out Old Grease and Repacks Bearings with New Grease
- Transparent, Impact Resistant Cup Allows User to Clearly See Grease Level
- Works on Bearings with Up to 3-1/2" Outside Diameter



### Universal Bearing Packer

SKU **1339731** **13<sup>99</sup>**  
25081

- Connects to Any Grease Gun
- Services Most Roller and Ball Bearings
- Forces Out the Old Grease and Evenly Injects Fresh Grease



## Lincoln

### 20V Li-ion PowerLuber Kit

SKU **751676** **489<sup>99</sup>**  
LIN1884

- Delivers Grease at Up to 10,000 psi
- Built-In LED Illuminates the Work Area
- Includes: Grease Gun, 2 Batteries, Charger and Case
- 36" Flex Hose



### 12V Li-ion PowerLuber Kit

SKU **605324** **339<sup>99</sup>**  
LIN1264

- Li-ion Battery for Maximum Power and Efficiency
- Delivery at Up to 8,000 psi
- Built-In LED Illuminates Dimly Lit Areas
- 30" Grease Hose



### Fully Automatic Pneumatic Grease Gun

SKU **445386** **159<sup>99</sup>**  
LIN1162

- Fully Automatic, Continuous Operation
- 30" High-Pressure Hose with Coupler and Attachment Clip
- Pump Ratio: 40:1 at 150 psi
- Max. Grease Pressure: 6,000 psi



### Super Pistol Grip

SKU **445385** **89<sup>99</sup>**  
LIN1134

- 18" Whip Hose
- Includes Rigid Pipe
- Variable Stroke Design
- 7,500 psi
- Filler Nipple/ Bleeder Valve



### Professional Lever Grease Gun with 18" Whip Hose and Coupler

SKU **522903** **69<sup>99</sup>**  
LIN1147

- 3-Way Loading: By Cartridge, Bulk Load and Suction Load



Prices subject to change without notice. Prices do not include applicable taxes, vehicles, tires, rims, installation or optional equipment as shown. Please do not return purchases to the store. For information regarding warranty, repair, or any questions or concerns, call 901-300-4878.

AZG0125

25

# OIL CHANGE

## Oil Drains

**LINCOLN**

### 18 Gallon Rolling Oil Drain

SKU 988882 **389<sup>99</sup>**  
LIN3601

- All Steel Design Includes Reinforced Caster Supports
- 14" Telescoping Bowl: Range of 45" to 72"
- Preset Air Regulator (Up to 150 psi)
- Pressurized Self-Evacuation Feature Requires Only Shop Air and a Tire Chuck to Discharge Fluids



### 25 Gallon Used Fluid Combo Drain/Evacuator

SKU 543345 **789<sup>99</sup>**  
LIN3639

- Powerful Compressed Air Operated Venturi Vacuum Quickly Draws Fluids from Reservoirs
- Includes: Mercedes-Benz, BMW and VW Dipstick Tube Adapters and 6 Evacuation Wands of Varying Flexibility, Diameter and Length
- Pressurized Self-Evacuation Feature Requires Only Shop Air and a Tire Chuck to Discharge Fluids
- Min. Height: 60"
- Max. Height: 74"



### 25 Gallon Used Fluid Evacuator

SKU 543344 **609<sup>99</sup>**  
LIN3637

### 25 Gallon Used Fluid Gravity Drain

SKU 543350 **729<sup>99</sup>**  
LIN3635

**LINCOLN**

**OEM TOOLS**

### 18 Gallon Rolling Oil Drain

SKU 667005 **299<sup>99</sup>**  
87042

- Pressurized Self-Evacuation Feature Requires Only Shop Air
- Funnel Capacity: 2.6 Gallons
- Funnel Diameter: 17"
- Min. Height: 44.5"
- Max. Height: 68.5"



**OEM TOOLS**

### 21 Gallon Oil Drain Vacuum and Extractor

SKU 546658 **599<sup>99</sup>**  
24862

- Designed for the Collection of Used Fluids from Lift Mounted Vehicles or by Evacuation Directly from Fluid Reservoirs or Dipstick Tubes
- Funnel Diameter: 15"
- Funnel Extension Adapter: 22"
- Funnel Height Adjustment: 45" to 62"
- Includes 5 Extraction Tubes: (1) 7 mm x 35"; 6 mm x 29"; 6 mm x 23"; 6 mm x 22" and 3/8" x 15"



### 9 Gallon Upright Portable Oil Drain

SKU 908386 **139<sup>99</sup>**  
87032

- Adjustable Drain Height: 32" to 62"
- Funnel Diameter: 17"
- Features Built-In Drain Valve and Evacuation Spout
- 4 Heavy Duty Casters for Easy Transport
- Includes: Tool Holder



Tool Tray



Easily Pour Out Used Oil



**OEM TOOLS**

### 18 Gallon Upright Portable Oil Drain

SKU 908388 **199<sup>99</sup>**  
87031

- Adjustable Drain Height: 54" to 70"
- Funnel Diameter: 18"
- Features Built-In Drain Valve and Evacuation Spout
- 4 Heavy Duty Casters for Easy Transport
- Includes: Tool Holder



Tool Tray



Drain Valve



**OEM TOOLS**

### 21 Gallon Waste Oil Drain

SKU 544817 **415<sup>99</sup>**  
24861

- Pressurized Self-Evacuation Feature Requires Only Shop Air
- Large Diameter Funnel Includes a Removable Filter Screen and Wide-Mouth Extension
- Funnel Diameter: 15"
- Funnel Extension Diameter: 22"
- Funnel Height Adjustment: 45" to 62"



Large Funnel

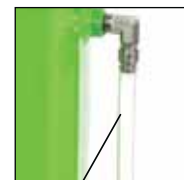

Sight Tube Catches Fluids without Spills



**BONUS** VALUE: \$19.99

### Mini Lever Action Grease Gun

87206

With Purchase of:  
87032

Offer Good While Supplies Last Through  
March 31, 2025



Prices subject to change without notice. Prices do not include applicable taxes, vehicles, tires, rims, installation or optional equipment as shown. Please do not return purchases to the store. For information regarding warranty, repair, or any questions or concerns, call 901-300-4878.

## Used Fluid Drains

### Evacuation Systems

- All-Steel Tank and Base
- Easy-to-Use Patented Cantilever Mechanism

**Premium Drains Capture Used Fluids and Transfer Them to Any Bulk Storage Tank Using a Cam-Lock Kit and Evacuation System**

### Anti-Freeze

SKU 1485042  
BAL4110-025

**849<sup>99</sup>**

- Powder-Coated Green
- 3/4" Cam-Lock Fitting

**NEW**

Made in USA

### Oil

SKU 1485039  
BAL4110-024

**849<sup>99</sup>**

- Powder-Coated Black
- 1" Cam-Lock Fitting



## Accessories

Prevents Splashing of Hot Oil

### Oil Drain Splash Pads

- Keeps Work Areas Clean While Changing Transmission or Other Oils
- Allows Hot Oil to Drain Through Porous Pad



### 15" Round

SKU 1340218  
SHA73850

**19<sup>99</sup>**



### 22" Square

SKU 1340219  
SHA73851

**24<sup>99</sup>**



Drains Not Included. Not for Coolants or Fluids That Will Be Recycled in the Vehicle

### Super Transmission Drain Funnel

SKU 291377  
LIS17902

**79<sup>99</sup>**

- Extends the Catch Area of Any Lift Drain
- Fits the Ford E 40D
- Dimensions: 24" x 36"



### Transmission Drain Pan

SKU 908383  
87035

**29<sup>99</sup>**

- Flexible Plastic Construction Fits on Top of Funnels for Most Lift Drains
- Built-In Screen to Catch Debris, Parts and Tools
- Dimensions: 22-3/4" (L) x 23-3/4" (W) x 4-3/4" (H)



## Change Oil Your Own Way: Save with Featured Kits

### Oil Change Service Kit

SKU 1169110 | 68915

- Includes: Oil Filter Wrench Pliers, Oil and Transmission Funnel, 3-Legged Oil Filter Wrench, 5 Quart Oil Dispenser, Drain Plug Socket Set, Professional Swivel Oil Filter Wrench Kit (Fits Sizes 2-3/8" to 4-3/8"), Safety Glasses and 9 Gallon Upright Portable Oil Drain



9 Gallon Oil Drain



**199<sup>99</sup>**

REG. \$284.92

**SAVE \$84 OVER**

When You Buy the Kit

### Oil Change Lube Tech Kit

SKU 1169108 | 68916

- Includes: Oil Filter Wrench Pliers, Oil and Transmission Funnel, 3-Legged Oil Filter Wrench, 10L Oil Jug, Drain Plug Socket Set, Professional Swivel Oil Filter Wrench Kit (Fits Sizes 2-3/8" to 4-3/8"), Safety Glasses, 18 Gallon Upright Portable Oil Drain and 10 Piece Metric Cap Wrench Set



18 Gallon Oil Drain



**299<sup>99</sup>**

REG. \$393.91

**SAVE \$93 OVER**

When You Buy the Kit

## Used Oil Evacuation

- Includes All Necessary Fitting, Brackets, Valves, Hoses and Components for Seamless Integration with Air System and Fluid Collection/Discharge Processes

**NEW**



### Evacuation Package for Used Antifreeze

SKU 1485050  
BAL1121-025

**1,729<sup>99</sup>**

### 1" Evacuation Package for Used Oil

SKU 1485032  
BAL1121-024

**1,749<sup>99</sup>**

# OIL CHANGE

## Oil Filter Tools

### Swivel Oil Filter Wrench

SKU 1125870 **11<sup>99</sup>**  
87115

- Fits Oil Filters 4-3/4" to 5-3/4"
- 1" Wide Stainless Steel Band



### Auto Fit Filter Pliers

SKU 1339727 **14<sup>99</sup>**  
87164

- Suitable for Filters with 2.4" to 5" Diameters
- Long Reach Slip Joint Design
- Precision Machined Jaw
- Non-Slip Comfort Grip



### 3 Jaw Adjustable Magnetic Oil Filter Wrench

SKU 908387 **19<sup>99</sup>**  
25101

- Oil Filter Diameter: 2.4" to 3.6" (60 mm to 93 mm)
- Secure Magnetic Attachment
- Spring-Loaded Legs for a Secure Grip
- Includes 3/8" to 1/2" Drive Adapter



### 3 Jaw Adjustable Filter Wrench

SKU 1339734 **16<sup>99</sup>**  
87160

- Works on a Variety of Vehicles
- Fits Oil Filters 2-1/2" to 4-1/2" (63.5 mm to 114 mm)
- Fits 3/8" Drive Ratchets and Extensions
- Perfect for Removing Hard to Reach Filters



### 4 Piece Swivel Oil Filter Wrench Set

SKU 1414418 **34<sup>99</sup>**  
87117

- Fits Oil Filters 2-3/8" to 2-7/8", 2-7/8" to 3-3/8", 3-3/8" to 3-3/4" and 3-3/4" to 4-3/8"
- Dimpled Band with 3 Sets of Grippers to Hold Filter Securely in Place
- 1" Wide Stainless Steel Band for a Strong Grip and Slip Resistance
- Rubber Cushioned TPR Grip for Comfort and Safety in Tight Places
- Includes OEMTOOLS 87111, 87112, 87113 and 87114



### 4-in-1 Steel Oil Filter Wrench

SKU 1189097 **14<sup>99</sup>**  
87116

- 4 Interchangeable Swivel Bands
- Size Range 2-3/8" to 4-3/8" (60.3 mm to 111.1 mm)
- 1 Swivel Handle with 4 Stainless Steel Bands
- Bands are Easily Removed and Installed



180° Swivel Joint Reaches Impossible Places

2 Detent Pins Help Quickly Remove and Install Bands



### 2-3/8" to 5" Oil Filter Pliers

SKU 757057 **18<sup>99</sup>**  
25324

- Removes Stubborn Oil Filters from Gas or Diesel Engines
- Long Reach Slip Joint Design
- Precision-Machined Jaw
- Non-Slip Comfort Grip
- 14" Length



### 2-1/2" to 4-5/8" Oil Filter Pliers

SKU 548380 **13<sup>99</sup>**  
25320

- 20° Jaw Bend for More Applications
- Jaw Teeth for Sure Grip
- 12" Length



### 12" Chain Wrench

SKU OUTSIDE BUY/EPO **44<sup>99</sup>**  
TIT21370

- Rated Pipe Capacity: 2" (50 mm)
- Actual Outside Diameter Capacity: 4" (100 mm)
- Chain Length: 15" (381 mm)



For Outside Buy/EPO, Call 901-300-4878

**TITAN**

### Heavy Duty Truck Oil Filters

- Extra Wide Band for Secure Grip
- 1/2" Drive Tools



SKU	Part #	Range	Price
344322	25231	4-1/8" to 4-5/8" (104 to 118 mm)	<b>19.99</b>
344323	25232	4-5/8" to 5-1/4" (118 to 134 mm)	<b>19.99</b>
344324	25233	5-1/4" to 5-3/4" (134 to 142 mm)	<b>21.99</b>

### Oil Filter Plug for Cummins

SKU 1340221 **14<sup>99</sup>**  
87168

- Perfect Tool for Installing and Removing Oil Filters
- Compatible with Dodge 6.7 Diesel Engines
- Prevents Oil Leaks When Removing Oil Filters from Engines
- Hard Plastic Construction for Maximum Strength and Durability
- Wide U-Shaped Handle for Added Grip and Control



### Filter Removal Cup

- Specifications: 6" x 6" x 6" (34 Oz. or 1 Liter), Volume Sufficient to Hold Typical Size Filters Commonly Used on Cars, SUVs, Light Duty Trucks and Vans
- Safely Holds Oils, Fuel (Gasoline, Diesel, Biofuels), Brake Fluid, Antifreeze and Other Hazardous Fluids



1 Pack  
SKU 1089033 **29<sup>99</sup>**  
SURFC5

2 Pack  
SKU 1245617 **37<sup>99</sup>**  
SURFC5PK2



REG. \$59.98

SAVE OVER **\$21**

When You Buy the 2 Pack

### Swivel-Gripper "No-Slip" Filter Wrench - 9 Pack

SKU 1339725 **179<sup>99</sup>**  
LIS57160

- Includes:
  - (2) 2.375" - 2.625" Import Wrenches
  - (2) 2.875" - 3.250" Small Wrenches
  - (3) 3.500" - 3.875" Standard Wrenches
  - (2) 4.125" - 4.500" Large Wrenches



*Lisle*

## Cap Style Filter Wrenches

### Toyota/Lexus Oil Filter Cap Wrench Set

SKU 383457 **22<sup>99</sup>**  
25409

- Sizes: 64 mm, 73 mm and 74 mm
- Comes in Sturdy Blow Mold Case



### 9 Piece Oil Filter Cap Wrench Set

SKU 255627 **99<sup>99</sup>**  
27199

- Includes: 5 Chrome Plated Aluminum Wrenches (64.5 mm - 14 Flute Toyota, 64.5 mm - 14 Flute Toyota/Lexus, 88.8 mm - 15 Flute Hyundai/Kia, 74.2 mm - 14 Flute European, 86.6 mm - 6 Flute European), (1) 63 mm to 83 mm Adjustable Filter Wrench for Universal Applications, 3 Forged Low Profile Oil Filter Sockets (27 mm, 32 mm and 36 mm) and 3/8" Drive Application Chart for Quick Reference



### 10 Piece Metric Cap Wrench Set

SKU 1189096 **34<sup>99</sup>**  
87151

- Painted for Rust Resistance
- Includes: 65/67 mm - 14 Flutes, 80 mm - 15 Flutes, 68 mm - 14 Flutes, 86 mm - 16 Flutes, 74/76 mm - 15 Flutes, 93 mm - 15 Flutes, 76 mm - 14 Flutes, 93 mm - 36 Flutes, 76 mm - 30 Flutes, 100 mm - 15 Flutes
- Comes in Sturdy, Green Blow Mold Case



**OEM TOOLS**

Make	SKU	Part #	Size	Price	
BMW/Volvo	255675	25453	86.6 mm - 16 Flutes	<b>19.99</b>	
Hyundai/Kia	255659	25454	88.8 mm - 15 Flutes	<b>25.99</b>	
Toyota/Lexus	255634	25451	64.5 mm - 14 Flutes	<b>10.99</b>	
Toyota/Lexus	1340227	87131	64.5 mm - 14 Flutes	<b>9.99</b>	
Mercedes-Benz Sprinter/VW/Audi Porsche/Mazda	1340230	87132	74.2 mm - 14 Flutes	<b>4.99</b>	
Mazda/Ford	1340228	87133	75.6 mm - 14 Flutes	<b>4.99</b>	
Chrysler	1340234	87134	84 mm - 14 Flutes	<b>23.99</b>	
Volvo	1340237	87136	88.8 mm - 15 Flutes	<b>21.99</b>	
Land Rover	1340238	87137	90 mm - 15 Flutes	<b>22.99</b>	

## Drain Plug Tools

**OEM TOOLS**

### 14 Piece Drain Plug Socket Set

SKU 818568 **29<sup>99</sup>**  
25374

- Designed for Both Foreign and Domestic Vehicles Including: BMW, Ford, Mazda, Mercedes-Benz, Nissan, Peugeot, Renault and More
- Ideal for Removal of Oil Drain Plugs from Manual Transmissions, Transfer Cases, Differential Housings and More
- Includes Hex: 9, 10, 12, 14 and 17 mm; Square: 7, 8, 11, 13 mm, 5/16", 3/8"; Female Square: 10 mm; Male Triangle: 10 mm; Tamper-Proof Triple Square: 16 mm

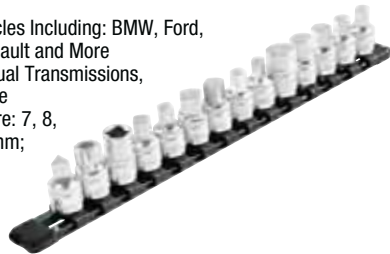

### 8-in-1 Oil and Lube Multi-Wrench

- Designed to Fit Most Oil Drains, Transfer Case and Differential Plugs
- Features Offset Head Design with Yoke Support for High Torque Applications



SKU 1442594  
CTA2495K

**49<sup>99</sup>**

- 6 Point Metric
- Sizes: 12, 13, 14, 15, 16, 17, 18 and 19 mm



SKU 1442585  
CTA2497K

**47<sup>99</sup>**

- Male Square and Hex
- Square: 8 mm, 10 mm, 3/8" and 1/2"
- Hex: 10, 12, 14 and 17 mm



### Plastic Oil Drain Plug Removal Set - 3 Piece

SKU 1207894 **19<sup>99</sup>**  
25098

- Safely and Easily Removes Plastic Oil Drain Plugs on Late Model Ford, Volkswagen, BMW and Audi Cars
- 3/8" Drive
- Does Not Cause Damage to the Plug

**OEM TOOLS**



## Oil Filter Sockets

### 7 Piece Oil Filter Removal Socket Set

SKU 191682 **37<sup>99</sup>**  
27197

- 3/8" Drive
- Includes: 24 mm for Cadillac; 27 and 36 mm for Mercedes-Benz, VW, Cadillac, Buick, Saturn, SAAB; 29 mm for Dodge Cummins Fuel Filter; 30 mm for Korean Cars; 32 mm for GM, Saturn and SAAB; 35/36 mm for Ford Diesel, Mini Cooper, BMW and Mack; 38 mm for Vauxhall Vectra
- Comes in Sturdy, Green Blow Mold Case



### 7 Piece Offset Oil Filter Cap Wrench Set

SKU 1145990 **25<sup>99</sup>**  
87165

- 3/8" Drive Set Includes: 24 mm for Cadillac; 27 and 36 mm for Mercedes-Benz, VW, Cadillac, Buick, Saturn, Saab; 29 mm for Dodge Cummins Fuel Filter; 30 mm for Korean Cars; 32 mm for GM, Saturn and SAAB; 35/36 mm for Ford Diesel, Mini Cooper, BMW and Mack; 38 mm for Vauxhall Vectra
- Comes in Sturdy, Green Blow Mold Case



**OEM TOOLS**

### 32 mm Oil Filter Cap Socket

SKU 548385 **10<sup>99</sup>**  
25410

- Removes and Installs Oil Filters on 2.2 Liter GM Ecotec Engines Low Profile 1-1/4 In. Socket is Specially Designed for Operating Clearance 3/8" Drive



### 36 mm Oil Filter Socket for 6.0L Ford Diesel

SKU 110279 **11<sup>49</sup>**  
25411

### 3 Piece Low Profile Oil Filter Socket Set

SKU 094803 **21<sup>99</sup>**  
27204

- Includes: 27, 32 and 36 mm
- 3/8" Drive



# OIL CHANGE

## Oil Funnels



### Magnetic Funnel Holder

SKU 1372897 **9<sup>79</sup>**  
98375

- Translucent 16.9 Oz. Reservoir Holds a Variety of Funnels
- Dual Magnetic Arms Attach the Holder Securely to Any Ferrous Surface
- Magnets Securely Hold Up to 28 Oz. in Weight
- Swivel Design Allows for Easy Screw-In of the Receptacle Bottle
- Fits Standard One Quart Oil Bottle
- End Cap Keeps Drips off the Floor



Magnetic Arms to Hold Securely in Place



STORE STOCKED

## OEM TOOLS

### Oil and Transmission Funnel

SKU 547009 **24<sup>99</sup>**  
87008

- Both Straight and 45° Angle Screen to Prevent Trash from Entering Transmission
- Includes Screen and Dust Cap
- Length: 25"



## No Spill Oil Funnels

## OEM TOOLS

### Universal Direct Fit No Spill Oil Funnel Set

SKU 824884 **79<sup>99</sup>**  
87039

- Set Includes: Universal Oil Funnel, Chrysler (87019), Ford/Mazda (87020), GM (87021), Honda (87022), Toyota/Lexus (87024), Subaru Adapter, Toyota/Lexus Adapter and 150° Extended Adapter (87027) and Storage Rack
- Funnel Screws Directly into Filler Neck
- Threaded to Fit a Range of Import and Domestic Vehicles Older and Current Models
- Transparent Lower Chamber to Monitor Oil Flow
- Wide Passage for Rapid Refilling



Includes Wall Mount Bracket and Drip Tray



## Dispensers



### 8 Quart Dispenser Lid and Cap

SKU 080078 **34<sup>99</sup>**  
LIS19702

- Spout Cap and Lid to Keep Out Contaminants
- Many Large SUVs and Trucks Now Require More Oil



### 10 Quart Oil Jug

SKU 605325 **39<sup>99</sup>**  
87018

- Safe for Automotive Oils and Fluids
- Convenient Carry and Pour Handles
- Spill Proof Caps

## OEM TOOLS



### Flexible Spout Measuring Cans

- Designed for One-Hand Operation
- 14" Flexible Spout with Tapered Tip
- Recessed Bottom Drains Fully and Guards Against Punctures
- Rolled-Edge Top Helps Prevent Spilling

**5 Quart**  
SKU 298486 **54<sup>99</sup>**  
LING525

**8 Quart**  
SKU 298473 **64<sup>99</sup>**  
LING528



## LINCOLN

## Drain Pans

## OEM TOOLS

### 16 Quart Oil Drain Pan

- Heavy Duty Polyethylene Construction
- Features a Pour Spout and No-Splash Lip



**Green**  
SKU 908389  
87034  
**32<sup>99</sup>**

**Black**  
SKU 908382  
87033  
**32<sup>99</sup>**

## OEM TOOLS

### 2.8 Quart Low-Profile Oil Drain Pan

SKU 568474 **10<sup>99</sup>**  
87017



Great for Motorcycles and Small Engines

## OEM TOOLS

### 4.7 Quart Clear Oil Drain Pan

SKU 568469 **13<sup>99</sup>**  
87013



Great for Transmission Fluid Changes

### 4.5 Gallon Black Oval Drain Pan

SKU 1142687 **49<sup>99</sup>**  
LIS17972

### 4.5 Gallon Green Oval Drain Pan

SKU 1142342 **49<sup>99</sup>**  
LIS17982



## Filter Crusher

## Ranger

### Industrial 10 Ton Oil Filter/Can Crusher

SKU OUTSIDE BUY/EPO  
RANRP20FC

**2,079<sup>99</sup>**

- Reduces Used Oil Filters to 1/4 of the Original Size
- 20,000 Lb. Crushing Power
- 100% Air Operated for Minimal Maintenance
- Save on Disposal Costs and Storage Space
- Automatic Safety Door Stops Operation When Opened
- Pressure Regulator and Air Moisture Separator Come Standard
- Transparent Door for a Convenient View of the Crushing Process
- Exclusive X-Shape Bevel in Press Head Pre-Aligns Filters for Absolute Vertical Press

**INCLUDES STAND**



For Outside Buy/EPO, Call 901-300-4878

# COOLING SYSTEM

TO ORDER, contact your Commercial Sales Manager or go to [AutoZonePro.com](http://AutoZonePro.com)

COOLING SYSTEM

## Pressure Testers

### SmartFit™ Universal Cooling System Test Kit

SKU 250709  
RED950700 **264<sup>99</sup>**

- Works on All Passenger Vehicles and Light Duty Trucks
- Eliminates the Need to Buy Costly Adapters for Radiators
- Made from Anodized Brass and High Quality Materials



### Universal Cooling System Adapter Set

SKU 434723  
27067 **69<sup>99</sup>** REG. \$79.99



**SAVE \$10**

- Designed to Fit Most Passenger Vehicles and Light Duty Trucks
- Fits Both Radiators and Plastic Reservoirs
- Universal Design Works with Any Cooling System Pressure Pump
- Prevents Damage to Plastic Reservoir Threads That Occurs When the Wrong Adapter is Forced On
- Pressure Test Pump Not Included



Offer Good Through March 31, 2025

### Cooling System Pressure Test Pump

SKU 434722  
27069 **79<sup>99</sup>**

- Quickly and Easily Pressure Test Cooling Systems in Most Vehicles
- High Quality Pressure Pump Designed to Work with Most Cooling System Adapters
- Easy-to-Use Lever Style Pressure Relief Valve



### Heavy Duty Cooling Test and Refill Kit

SKU 954220  
MSC43014 **119<sup>99</sup>**

- Includes: Vacuum Gauge, Sealing Collar, Valve, Rubber Gaskets and Coolant/Draining Hoses
- Sealing Collar (with Rubber Cone) Offers a Wide Variety of Applications for Radiator Filler Necks
- Minimizes the Risk of Engine Overheating
- 2.3 Gallons per Minute Fill Rate



### Heavy Duty Cooling Kit

SKU 954231  
MSC43306 **479<sup>99</sup>**

- Includes: Heavy Duty Vehicle Adapters, Pressure Test Regulator, Vacuum Refill Attachment with Tubing in a Plastic Case
- For Use with Freightliner, International, Kenworth, Peterbilt, Mack, Volvo, GMC and Sterling Cooling Systems
- Uses Shop Air to Pressure Check and Vacuum Refill
- 4 Quick-Disconnect Vacuum Attachments Provide Quick Refilling of the Cooling System and Eradicates Airlocks



### 27 Piece Master Radiator Pressure Test Kit

SKU 1053958  
MSC43301-A **359<sup>99</sup>**

- Includes: 1 Blue Radiator Cap Test Connector R123/R125, 1 Black Radiator Cap Test Connector R123/R124, 1 Thermometer, 1 Universal Radiator Cap, 1 Vacuum Purge and Refill Tool, Coolant Hose and Additional Installation Accessories, 1 Hand Pump and 19 Adapters (Nos. 2 to 4, 6 to 21) to Fit Most Popular Domestic and Import Cars and Trucks



## Cooling System Adapters

### Volvo, Saab, Jeep, Maserati, Ferrari

SKU 133600  
27241R **34<sup>99</sup>**

- Fits Maserati and Ferrari Models (2000 - Newer), Jeeps with Male Threads (1990 - 1994), Saab 900 (1978 - 1993), Saab 900 (Drop Top 1994), Saab 9000 (1987 - 1998), Volvos with Male Threaded Necks
- Diameter: 45 mm
- Thread Size: 3 mm



### Audi, Porsche and VW

SKU 133549  
27240R **22<sup>99</sup>**

- Fits Audis and VW with Male Threads on Filler Neck, Porsche Boxster (1997 - Newer), Porsche Cayenne (2006 - Newer) and Porsche 911 (1999 - Newer)
- Diameter: 48 mm
- Thread Size: 3 mm



### Audi and VW

SKU 133625  
27245R **32<sup>99</sup>**

- Fits Audi A4 (1996 - Newer), A6 (1998 - Newer), A8 (1997 - Newer), S4 (2004 - Newer), TT (2000 - Newer), Bentley (2006 - Newer), Lamborghini (2006 - Newer), Porsche Cayenne (2003 - Newer), Porsche Panamera (2010 - Newer), Volkswagen Passat (1998 - Newer), Beetle (1998 - Newer), Golf and Jetta (1999 - Newer)



### BMW 3, 5 and 6 Series Radiator Adapter

SKU 133825  
27252R **40<sup>99</sup>**

- Fits BMWs (2007 - Newer), 5 and 6 Series (2005 - Newer) and 3 Series (2006 - Newer)
- Diameter: 52 mm
- Thread Size: 3 mm



### Mazda 3, Volvo S40/V50 and Ford

SKU 133633  
27249R **39<sup>99</sup>**

- Fits Land Rover LR-2 (2008 - Newer), Mazda 3 (2004 - Newer), Volvo S40 and V50 (2004 - Newer), XC60 (2010 - Newer), Ford Fusion and Escape (2012 - Newer)
- Diameter: 50 mm; Thread Size: 2.5 mm



### Toyota, Lexus and Scion Radiator Adapter

SKU 133632  
27248R **37<sup>99</sup>**

- Fits Lexus LS (2007 - Newer), Toyota Celica (2000 - Newer), Spyder MR2 (2000 - Newer), RAV4 (2009 - Newer), Prius (2004 and Newer), Camry (2007 - Newer), Highlander (2006 - Newer) and Scion XB (2008 - Newer)
- Diameter: 34 mm; Thread Size: 3 mm



### Acura, Chevrolet, Chrysler, Geo, Honda, Isuzu, Lexus, Mazda, Mitsubishi, Suzuki and Toyota

SKU 133624  
27244R **24<sup>99</sup>**

- Fits Early Models with 32 mm Opening and a 9 mm Depth



### BMW and Range Rover Radiator Adapter

SKU 133635  
27251R **34<sup>99</sup>**

- Fits BMWs 1988-2006, Land Rover and Range Rover Models 1995-2005
- Diameter: 52 mm
- Threads: 4 mm



### Ford, Jaguar, Pontiac, Range Rover and Saab Radiator Adapter

SKU 133611  
27243R **31<sup>99</sup>**

- Fits Jaguar X Type (2002 - Newer), Saab 900 (1994 - 1998), Saab 9-3 and 9-5 (1999 - Newer), Some Saturns and Other Vehicles
- Diameter: 52 mm; Thread Size: 3 mm



### VW

SKU 133609  
27242R **34<sup>99</sup>**

- Volkswagens with Female Threaded Filler Necks (1990 to 1998)
- Diameter: 57 mm; Thread Size: 3 mm



### Ford, Jaguar and Mazda Radiator Adapter

SKU 133631  
27247R **35<sup>99</sup>**

- Ford Contour 1998-2000, Jaguar XJ8 1998-Up, Jaguar XK8 1997-2006, Mazda Tribute 2001-Up
- Diameter: 52 mm; Thread Size: 3 mm



Prices subject to change without notice. Prices do not include applicable taxes, vehicles, tires, rims, installation or optional equipment as shown. Please do not return purchases to the store. For information regarding warranty, repair, or any questions or concerns, call 901-300-4878.

AZG0125

# COOLING SYSTEM

## Coolant Funnels

### Professional No-Spill Coolant Funnel Kit

SKU 943142 **39<sup>99</sup>**  
87043

- 5 Spring-Loaded Adapters for a Secure Fit
- Simply Select the Correct Adapter, Attach the Funnel and Fill
- Air-Release Tubes to Vent the System During Refilling Process
- Stopper Prevents Dripping When Removing the Funnel
- Includes: Extensions and Adapters for Hard-to-Reach Surge Tanks



OEM TOOLS

### No-Spill Coolant Filling Funnel Kit

SKU 802197 **19<sup>99</sup>**  
87007

- 4 Radiator Cap Adapters to Fit Most Passenger and Light Trucks
- Simply Select Correct Adapter, Thread Together, Attach the Funnel and Fill
- Rotary Switch to Effectively Prevent Drips and Spills, and Stop Overflow and Bubbles
- Includes: 5 Adapters, (2) 45° Elbows and (2) 5" Extension Rods for Difficult-to-Reach Areas



STORE STOCKED

### No-Spill Coolant Filling Funnel Kit with Coolant Tester

SKU 1340229 **25<sup>99</sup>**  
87045

- Includes 5 Direct Fit Cooling System Adapters to Fit Most Passenger Vehicles and Light Trucks
- Includes: 45° Angled and 5" Extension Adapters for Accessing Hard-to-Reach Spots and Tester for Glycol Based Coolants
- Fluid Stopper to Prevent Drips and Spills When Removing from the Filler Neck



## Leak Tester

### Gas Engine Combustion Leak Tester

SKU 1103608 **29<sup>99</sup>**  
37145

- Used to Test for Combustion Leaks That Result from Head Gasket, Cylinder Head and Engine Block Leaks
- Pulls Air from the Cooling System Up Through the Leak Tester; if Carbon Dioxide is Present, the Leak Tester Fluid Color Will Change to Yellow Signifying a Combustion Leak



OEM TOOLS

### Combustion Leak Detector Fluid (8 Oz.)

SKU 391381 **9<sup>99</sup>**  
25739



STORE STOCKED

## Radiator Filler

### 2.4 Gallon Plastic Radiator Filler

SKU 754738 **24<sup>99</sup>**  
87104

- Impervious to Oil, Gasoline and Antifreeze
- Stands Up to Extreme Weather



OEM TOOLS

## AirEvac Cooling System

### AirEvac Cooling System Refiller

SKU 568478 **89<sup>99</sup>**  
24444

- Quickly Refills Cooling System and Eliminates Trapped Air
- Helps Prevent Come-Backs and the Threat of Engine Damage
- Universal Adapter Forms an Airtight Seal with Most Radiator and Coolant Bottle Necks
- Performs Vacuum Leak Tests
- Covers Most Radiator and Reservoir Types
- No Custom Adapters Required
- Comes in Sturdy, Green Blow Mold Case

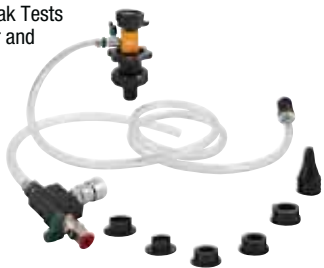

### AirEvac Cooling System Kit

SKU 099292 **79<sup>99</sup>**  
27066

- Uses Shop Air to Evacuate the Cooling System for Vacuum Leak Testing
- Refills Cooling System without Trapping Air That Causes Overheating
- Universal Adapter Forms an Airtight Seal with Both Radiators and Coolant Reservoirs
- Self-Locking Quick Disconnects for Fast Assembly



OEM TOOLS

## Coolant Testing

### Professional Series Ethylene Glycol Antifreeze Tester

SKU 750007 **13<sup>99</sup>**  
24507

- For Testing Hot or Cold Ethylene Glycol-Based Coolants, Including Dex-Cool®
- Easy-to-Read Discs are Magnified by Convex Design of the Clear, Thermal Resistant Plastic Barrel
- Disc-Type 16-1/4" Tester is Accurate at All Temperatures (Celsius and Fahrenheit Scales)



(Color May Vary)

OEM TOOLS

## Flush Tools

### Coolant System Flush Gun

SKU 1284967 **39<sup>99</sup>**  
24719 REG. \$49.99

- Universal Nozzle to Fit Various Radiator or Heater Hoses
- Combines Water with Compressed Air to Quickly and Efficiently Flush Cooling Systems
- Comfortable Lever-Action Air Throttle with Lock-On Latch for Simple Attachment of Air Hoses
- Used for the Detailed Flushing of Debris and Contaminants from the Cooling System During Repair and Maintenance

Offer Good Through March 31, 2025



OEM TOOLS

### Heater Core Backflush Tool

SKU 511000 **36<sup>99</sup>**  
THX356

- Fits 1/2", 5/8" and 3/4" Heater Hoses
- Saves Costly Replacement of Most Stubbornly Clogged Heater Cores



- Made of Corrosion-Resistant Aluminum
- Basic Garden Hose Hook-Up Cleans Cooling Systems and Heater Cores without Disassembly

THEXTON

### Cooling System Back Flush Tool

SKU 750008 **29<sup>99</sup>**  
24506

- Non-Corrosive Aluminum
- Easy to Use

- Connects to Standard Hose 1/2", 5/8" and 3/4" Hose Fittings
- Made of Non-Corrosive Aluminum



OEM TOOLS



# COOLING SYSTEM

TO ORDER, contact your Commercial Sales Manager or go to [AutoZonePro.com](http://AutoZonePro.com)

COOLING SYSTEM

## Cooling System Tools

### 6 Piece Hose Clamp Pliers Set

SKU 1282734  
27158

- Services Most Ring-Type or Flat-Band Hose Clamps
- Clamps are Held Open with a Ratchet Locking Mechanism
- Includes: Regular Hose Clamp Pliers, Flat-Band Hose Clamp Pliers, Large Hose Clamp Pliers, Hose Remover Pliers, Angled Hose Clamp Pliers and Cable Hose Clamp Pliers



OEM TOOLS

**76<sup>99</sup>**  
REG. \$103.99

**SAVE \$27**

When You Buy the Kit

### 4 Piece 14" Jumbo Pick Set

SKU 94658  
25940

**29<sup>99</sup>**  
REG. \$34.99

- Includes: Straight Pick, 90° Pick, Offset Pick and Hook Pick

**SAVE \$5**

OEM TOOLS



Offer Good Through March 31, 2025

### Clic-R Hose Clamp Pliers

SKU 1089038  
25102 **16<sup>99</sup>**

- Easily Remove or Install Clic-R Type High Tension Clamps
- Heavy Duty and Durable Steel Construction
- Clamps Commonly Found on BMW, Mercedes-Benz, Audi, VW and Other Cars and SUVs



OEM TOOLS

### Hose Remover Set - 5 Piece

SKU 1335785  
26519 **19<sup>99</sup>**

- Dual Durometer Handles for Comfort and Grip
- Hooks and Picks are Assembled from Carbon Steel for Strength and Durability
- Perfect for the Removal of Coolant Hoses, Cotter Pins Brake Springs, Large Electrical Connectors and More

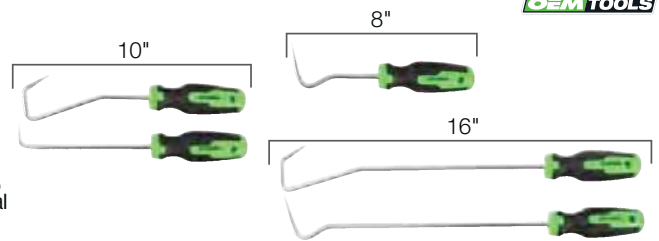

OEM TOOLS

### GM Water Pump Socket

SKU OUTSIDE BUY/EPO  
27109 **29<sup>99</sup>**

- Works on 1993-newer Cadillac Northstar 4.6L V8 Engine (1993-newer) and Oldsmobile Aurora 4.0L L47 V8 (1995-1999) 1/2" Drive
- Black Oxide Finish to Resist Rust
- Chrome Vanadium Steel for Toughness



OEM TOOLS

### Master Freeze Plug Installer Kit

SKU 965837  
27208 **69<sup>99</sup>**

- Designed to Remove and Install Freeze Plugs Used in Liquid-Cooled Gas and Diesel Engines



OEM TOOLS



## Coolant Exchangers

MAHLE

### VCX-1 Vacuum Coolant Exchanger

SKU OUTSIDE BUY/EPO  
MSS4708001900  
**2,799<sup>99</sup>**

- Extremely Fast Service Cycles
- Simple Hook-Up and Operation
- Flexible Adaptation for Most Makes and Models



Coolant Not Included

### FluidPRO® MCX-2 Multi-Coolant System Fluid Exchanger

SKU OUTSIDE BUY/EPO  
MSS4708003000 **2,879<sup>99</sup>**

- Includes System Pressure Test Feature and "Hot Car" Radiator Cap Pressure Release
- Compatible with All Coolant Types for Adaptability
- Contains (2) 7.5 Gallon New Coolant Tanks and (1) 15 Gallon Waste Tank Providing Simple, Rapid Switching from One Coolant to Another
- 3 Minute Service Time for Increased Productivity



Coolant Not Included

MAHLE

### Vacufill Air Operated Coolant Exchanger with Drain Pump

SKU OUTSIDE BUY/EPO  
UVU570000X  
**1,699<sup>99</sup>**

- Includes: Auxiliary Pump for Emptying Waste Reservoir
- Large 12 Gallon Waste Coolant Reservoir
- Connects Easily to Engine Cooling Systems
- Large 3 Gallon New Coolant Tank
- Eliminates Potential Airlock Problems
- Tests for Leaks While Under Vacuum



Waste Pump

Coolant Not Included



VIEW

To Confirm Price, Availability and Ordering Instructions on Outside Buy/EPO, Call 901-300-4878

Prices subject to change without notice. Prices do not include applicable taxes, vehicles, tires, rims, installation or optional equipment as shown. Please do not return purchases to the store. For information regarding warranty, repair, or any questions or concerns, call 901-300-4878.

AZG0125

33

# SPECIALTY TOOLS

## Line Repair Tools

### 3/16" Brake Line Kit

SKU 662854  
SURBR-EZ316 **189<sup>99</sup>**

- 110 Piece Kit Includes Most Popular Brake Nuts, Unions and Adapters
- Made in USA
- UltraBEND Tubing Easy to Flare and Bend without Kinking
- Smooth Flares Create Better Fittings Seals, Reduces Potential for Leaks
- Includes: 110 Pieces Plus 25' of UltraBEND 3/16" Tubing
- Standard (SAE) and Metric Fittings Included



### Deluxe Fuel Line Replacement Kit

SKU 662866  
SURKP1500 **549<sup>99</sup>**

- Repair or Replace 1/4", 5/16" or 3/8" Fuel Lines in as Little as 5 Minutes
- No Special Insertion Tools Required
- Thumb Release Convenience Includes 168 Pieces Plus 75' of Tubing
- No Specialty Tools Required
- Pressure Rated Up to 200 psi



### Universal Flaring Set

SKU 954227  
MSC72475-PRC **569<sup>99</sup>**

- Create Perfect Production Quality Flares
- Magnetic Adapter Holder Keeps Adapters in Place
- Tube and Die Set Stabilizing Arm for Easy Tube Forming
- Enlarged Die Set Compression Area for Better Grip of Dies



### Fuel Line Repair Assortment Kit

SKU 1392319  
DYNDY-FLA-2 **139<sup>99</sup>**

- Kit Includes 23 of the Top Selling Connectors, Fittings and Clamps
- 86 Total Pieces



### Pro Series Repair Assortment

SKU 1125882  
AIR78019 **499<sup>99</sup>**

- Everything You Need for Transmission and Power Steering Line Repair in One Convenient Kit - 16 Repairs
- 5 Minute Line Repair
- Leak-Free to 2,600 psi
- OE Approved



### Bubble Flaring Tool Kit

SKU 592261  
27214 **34<sup>99</sup>**

- Designed for Metric Soft Steel Brake Lines Where an "ISO" or Bubble Style Flare is Required
- Forged Yoke is Made of Heat-Treated Steel
- Includes: Flaring Bar, All Adapters Needed for ISO Bubble Flaring and 4 Dies (4.75, 6, 8 and 10 mm)



## Disconnect Sets

### NAVISTAR® MAXXFORCE® Fuel Line Disconnect Tool Set - 4 Piece

SKU 004112  
25031 **34<sup>99</sup>**

- 4 Piece Disconnect Tool Set for NAVISTAR® MAXXFORCE® Series 11 and 13 Engines
- Sized to Depress Fuel Release Tabs for Efficient Fuel Line Removal
- 1 Straight and (1) 90° Tool for 11.8 mm Fuel Lines;
- 1 Straight and (1) 90° Tool for 16 mm Fuel Lines



### Fuel Line Disconnect Set

SKU OUTSIDE BUY/EPO  
26514 **12<sup>99</sup>**

- Disconnects Fuel Lines and Spring Lock Couplings on Ford and Chrysler
- Sizes: 5/16", 3/8", 1/2", 5/8", 3/4" and 7/8"
- High Quality ABS Plastic That Can Easily Stand Up to Daily Usage
- Includes Reusable Holding Tray
- Easily Disconnects Air Conditioning and Quick Connect Fuel Lines



For Outside Buy/EPO, Call 901-300-4878

### 3 Piece Aluminum 1/2" Oil Line Disconnect Set

SKU 94653  
25187 **34<sup>99</sup>**

- Used to Remove and Replace Oil and Transmission Cooler Lines Found on GM, Ford, Nissan and Toyota Vehicles
- Anodized Aluminum Construction
- Quick Line Removal



### Angled Disconnect Set

SKU 291416  
LIS39400 **29<sup>99</sup>**

- Disconnects Spring Lock Couplings on Ford and Chrysler A/C Lines
- Works on Fuel Lines and Other Quick Disconnect Couplings on Domestic and Import Vehicles
- 6 Sizes: 5/16", 3/8", 1/2", 5/8", 3/4" and 7/8"



### Master Disconnect Tool Set

SKU 291413  
LIS39900 **79<sup>99</sup>**

- Contains 8 Tools for A/C and Fuel Lines
- Comes in a Blow Mold Case



### Coolant Hose Removal Tool Set

SKU 383214  
CAL244TNZ **34<sup>99</sup>**

- Used to Completely Fill the Void in the Connector to Release the Fastener
- 40° Offset Designed for Jobs Up Against the Firewall or in Tight Spaces

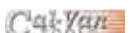

# SPECIALTY TOOLS

TO ORDER, contact your Commercial Sales Manager or go to [AutoZonePro.com](http://AutoZonePro.com)

SPECIALTY TOOLS

## Spark Plug Service

### 3/8" Drive Magnetic Spark Plug 3 Piece Socket Set

SKU 300140 **19<sup>99</sup>**  
22891

- Includes: 5/8", 9/16" and 13/16"



#### Spark Plug Sockets

SKU	Part #	Drive	Size	Features	Price
082923	22880	3/8"	9/16"	Magnetic	<b>7.99</b>
082933	22887	3/8"	5/8"	Magnetic	<b>9.99</b>
082929	22881	3/8"	18 mm	Magnetic	<b>9.99</b>
082932	22883	3/8"	13/16"	Magnetic	<b>9.99</b>
082934	22889	1/2"	13/16"	Magnetic	<b>9.99</b>
082936	22895	3/8"	14 mm	12 Point Thin-Wall	<b>9.99</b>

### 3/8" Drive Magnetic Spark Plug Socket Extra Long (5/8")

SKU 300146 **14<sup>99</sup>**  
22885

- Hard Chrome™ Finish is Easy to Clean and Protects Against Rust
- Chamfered Ends Make Fastener Engagement Quick and Smooth
- Magnetic and Won't Wear Out or Be Damaged By Oil
- Deep Marking for Easy Identification Knurling Position for Best Finger Gripping



### 3/8" Drive Magnetic Spark Plug Socket Extra Long (9/16")

SKU 300147 **15<sup>99</sup>**  
22886

### 3/8" Drive 14 mm x 12 Pt. Extra Long Spark Plug Socket

SKU 814337 **17<sup>99</sup>**  
22813

- Designed with a Universal Joint for the Installation and Removal of Spark Plugs Situated in Tight Spaces
- Durable Chrome Moly Steel Construction
- 12" Extended Reach



Swivel Joint

### Adjustable Spark Plug Boot Pliers

SKU 1340226 **19<sup>99</sup>**  
25559

- Jaws Adjust to Five Different Positions for Easy Access to Spark Plug Boots
- Rubber Dipped Jaws Provide a Secure Grip for Damage Free Removal of the Spark Plug Boot
- Hardened Jaws Will Not Bend When Gripping
- Dipped Handle Grips for a Comfortable and Sure Grip

OEM TOOLS



### Spark Plug Boot Pliers

SKU 390900 **13<sup>85</sup>**  
25542

- Designed to Remove Hard-to-Reach Spark Plug Boots
- 45° Offset Jaws for Easy Gripping of Wires and Boots



STORE STOCKED

### Spark Plug Wire Puller

SKU 532549 **4<sup>99</sup>**  
25061

- Insulates Hands from Electric Shock
- Grips Directly on Boot to Prevent Wire Damage



STORE STOCKED

## Specialty Sockets

### IPR Socket, 3/8" Drive

SKU 912334 **14<sup>99</sup>**  
25280

- Remove/Replace IPR without Damaging the Connector
- Applications: Ford 6.0 L and Other Diesel Engines



### Oxygen Sensor Socket Set

SKU 1103591 **21<sup>99</sup>**  
37110

- Special Purpose, Universal Slotted Socket That Services Hex Vacuum Switches and Oxygen Sensors
- Includes Sockets for Most Applications: 3/8" Drive 7/8" (22 mm) Deep, 3/8" Drive 7/8" (22 mm) Crowfoot, 1/2" Drive 7/8" (22 mm) Deep Crowfoot



### 7 Piece Sensor Socket Set

SKU 900823 **59<sup>99</sup>**  
27189

- Used for Oil Pressure Switches, Oil Pressure Sending Units and Thermal Sensor Switches
- Includes: 7/8" (22 mm) Offset Extended Oxygen Sensor, 7/8" (22 mm) Offset Oxygen Sensor Socket, 7/8" (22 mm) Vacuum Switch Socket, 7/8" (22 mm) Oxygen Sensor Socket, 1-1/16" (27 mm) Deep Oil Switch Socket, 1-3/16" (29 mm) Oil Sender Unit Socket and 1-1/16" (27 mm) GM Thermal Sensor Switch Socket
- Chrome Vanadium for Toughness



## Insulated Tools

### 10 Piece Insulated Screwdriver Set

SKU 1267942 **24<sup>99</sup>** REG. \$29.99  
22593

SAVE \$5

- 1,000V VDE Certified Insulated Screwdrivers
- Insulated Grip Handle and Precision Handle for Added Efficiency
- Insulation Sculpted Directly Onto Blade for Permanent Bonding
- Quick-Release Mechanism for Effortless Blade Change
- Exchangeable Blades with a Slim Tip to Fit Tight Terminal Blocks
- Durable Tool Pouch Included for Easy Organization
- Includes 4 Slotted Blades



OEM TOOLS



Offer Good Through March 31, 2025

Prices subject to change without notice. Prices do not include applicable taxes, vehicles, tires, rims, installation or optional equipment as shown. Please do not return purchases to the store. For information regarding warranty, repair, or any questions or concerns, call 901-300-4878.

AZG0125

# SPECIALTY TOOLS

## Fuel Pump Tools

OEM TOOLS

### Fuel Tank Adapter

SKU 1407554  
24832 **129<sup>99</sup>**

- Makes Fuel Tank Removal Safe and Easy
- Works with Most Transmission Jacks
- Includes: 2 Nylon Straps to Secure Tank
- Foam Rubber Pads Protect Tank



### Bed Lifter

SKU OUTSIDE BUY/EPO  
STK35885 **329<sup>99</sup>**

STECK

- Designed to Lift Truck Beds Safely and Easily
- Lifting Brackets Adjusts to Evenly Distribute Weight

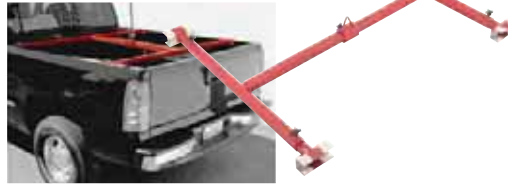

For Outside Buy/EPO, Call 901-300-4878

## Terminal Tools

OEM TOOLS

### 19 Piece Master Terminal Tool Set

SKU 447159  
27169 **139<sup>99</sup>**

- Latest Tools for Coolant Sensors, Wiring Harnesses and Terminal Blocks on Most Modern Vehicles
- Eliminates Potential Damage to Wires or Terminal Blocks
- Application Chart Included Inside Storage Case



### Fuel Pump Module Spanner Wrench

SKU 110278  
25156 **29<sup>99</sup>**

- Removes and Installs the Fuel Pump Retaining Ring



### Fuel Tank Lock Ring Tool

SKU 751721  
24398 **34<sup>99</sup>**

OEM TOOLS

- Ford F150 Trucks (2004 - Newer); Chrysler/Dodge Mini-Vans, PT Cruiser, Dakota, Durango (2004 - Newer); Chevy 1/2 Ton and 3/4 Ton Trucks (2004 - Newer)
- Works with 1/2" Drive Ratchet or Breaker Bar



### Adjustable Multi-Arm Lock Ring Tool

SKU OUTSIDE BUY/EPO  
25558 **29<sup>99</sup>**

- Interchangeable Arms to Remove and Install the Retaining Ring on the Fuel Pump Module
- Adjustable Arms to Easily Adjust to the Fitment of the Retaining and Locking Rings
- Slip Resistant Spanner to Limit Damage to the Lock Ring and Retaining Ring
- 3/8" Square Drive



For Outside Buy/EPO, Call 901-300-4878

## Remote Starter

OEM TOOLS

### Heavy Duty Remote Starter Switch

SKU 265127  
25331 **49<sup>99</sup>**

- Heavy Duty, Push Button Remote Starter Allows Technicians to Bump or Crank Engines While Under the Hood
- 67" Heavy Insulated Wire for Long Tool Life
- Heavy Duty Insulated Alligator Clips



## Throttle Depressors

OEM TOOLS

### Brake - Accelerator Pedal Depressor

SKU 802194  
24232 **34<sup>99</sup>**

- Holds Brake or Accelerator Pedal at Desired Position
- Easy to Adjust
- Extends to 24"
- Suitable for Many Diagnostic Applications



### Steering Wheel Holder and Pedal Depressor Set

SKU 802195  
24231 **64<sup>99</sup>**

OEM TOOLS

- Holds Steering Wheel in Position for Alignment Adjustments
- Depresses Brake Pedal for Various Brake Checks Including Brake Lamp Operation
- Simply Hand Squeeze the Actuator to Accomplish Fine Adjustments



### Throttle Pedal Depressor

SKU 222525  
LIS48700 **54<sup>99</sup>**

Lisle

- Holds Throttle at a Constant RPM
- Engage the Nylon Hook Under the Steering Wheel, Then Extend the Depressor Rod to the Accelerator Pedal
- Length: 40"

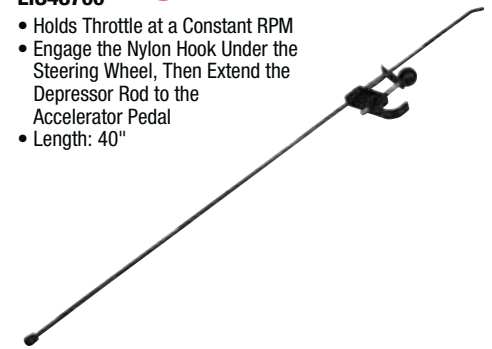

## Relay Tools

### Relay Puller Pliers

SKU 291342  
LIS46950 **34<sup>99</sup>**

- For Removing Electrical Relays on Most Domestic and Import Vehicles
- Allows Relay to Pop Free from Socket with Less Chance of Damaging the Relay



### Relay Test Jumper Set II

SKU 291341  
LIS60610 **114<sup>99</sup>**

- Includes 4 Jumpers to Fit Many Popular Relays on Honda, Nissan, Toyota, Newer Ford and GM Mini Micro Relays as well as International Trucks



### Relay Test Jumper Set

SKU 291333  
LIS56810 **114<sup>99</sup>**

- Includes 4 Jumpers to Fit the Most Popular Size Relays on Domestic and Import Vehicles
- Jumpers Have Tabs for Clamping and Flat Pads to Place Test Leads On



# SPECIALTY TOOLS

TO ORDER, contact your Commercial Sales Manager or go to [AutoZonePro.com](http://AutoZonePro.com)

SPECIALTY TOOLS

## Wire Strippers

### 7" Wire Stripper Crimper - Cutter

SKU 751657 **22<sup>99</sup>**  
24452

- Strips 20-12 Gauge Insulated and Non-Insulated Wire
- Use for Wire Cutting and Stripping, as Pliers for Grabbing and Twisting or for Crimping of Insulated and Non-Insulated Connectors
- Industrial Finish with Red Textured Grips



### 9-1/2" Terminal Crimping Pliers with Cutter

SKU OUTSIDE BUY/EPO **14<sup>99</sup>**  
25196

- For Insulated and Non-Insulated Wire Connectors and Terminals
- Specially Hardened Wire Cutter in Nose
- Tapered Nose for Working in Confined Spaces
- For 10 to 22 AWG Wire Connect
- Plastic-Dipped Comfort Handles Minimize Fatigue



For Outside Buy/EPO, Call 901-300-4878

### 8-1/4" Wire Stripper/Cutter/Crimper/Bolt Cutter

SKU 312821 **13<sup>99</sup>**  
25193

- AWG: 10, 12, 14, 16, 20 and 22 Stranded
- AWG: 8, 10, 12, 14, 16 and 18 Solid
- Crimps 7 and 8 mm Ignition Terminals



## Circuit Testers

### Digital Display Circuit Tester

SKU 568468 **29<sup>99</sup>**  
24451

- Detect Voltage, Power, Ground and Circuit Condition
- Display Provides Precise Voltage
- Voltage: 5 to 30V DC
- Computer Safe - DO NOT Use on Airbags



OEM TOOLS®



Voltage Display

### Coiled Cord Circuit Tester

SKU 422468 **7<sup>99</sup>**  
25886

- Circuit Tester with a Stretchable and Retractable 12' Cord for Long Circuit Runs



OEM TOOLS®

### One Handed Wire Piercing Circuit Tester

SKU 422469 **18<sup>99</sup>**  
25887

- Bright Hi-Vis 12' Heat and Oil Resistant Coiled Cord
- Molded Strain Relief for Long Life
- Hangs on Wire for Hands-Free Operation
- 6, 12 and 24 Volt Systems



OEM TOOLS®

### Three Way 30 Amp Circuit Tester Kit

SKU 107725 **54<sup>99</sup>**  
ESI309A

- Tests All 3 Fuse Sizes (Micro, Mini and ATO Circuits)
- Plug-In Fuse Buddy and Read Circuit Amp Draws Up to 30A



ES

### ECT3000 Electrical Circuit Tracer

SKU 1392338 **149<sup>99</sup>**  
PWPECT3000B

- Automatic and Manual Sensitivity Locking
- Arrow Indicates Direction to Short
- Signal Distance Indicator Bar
- 10 Minute Auto Shut Off
- Ergonomic Housing



POWER PROBE®

## Windshield Tools

### Compact Windshield Wiper Arm Puller

SKU 191681 **12<sup>99</sup>**  
25319

- Easily Removes Wiper Arms on Most Domestic and Foreign Vehicles
- Will Not Damage Wiper Arm or Hood Cowling During Removal
- Features Turning Knob for Fast Work and Forged Body for Strength
- Compact Design Works Great in Tight Spaces



OEM TOOLS®

### Window Holder

SKU 191670 **14<sup>99</sup>**  
25309

- Works on All Cars and Trucks with a Top Door Frame
- Loop Cable Over Door Frame and Attach Suction Cups to Each Side of Glass
- Window Glass is Securely Held Above the Door While Work is Performed

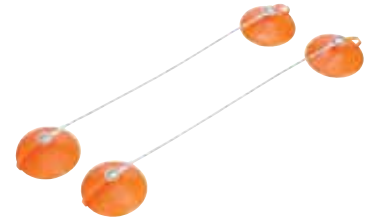

OEM TOOLS®

### Universal Wiper Arm Puller

SKU 265136 **29<sup>99</sup>**  
25339

- For Pulling Front and Rear Wiper Tight Fitting Wiper Arms
- Suitable for Most Wiper Arms Including Audi®, VW®, BMW®, Ford®, Chevrolet®, Mercedes-Benz® and Others
- Designed to Prevent Damage to Wiper Arm Nozzle



OEM TOOLS®

### Window Molding Clip Remover

SKU 265130 **5<sup>99</sup>**  
25338

- Use to Release Body Molding Clips
- Double-Sided Design Works on a Variety of Clip Configurations
- Made with Heat-Treated Carbon Steel for Strength



OEM TOOLS®

### Double Head Suction Cups

SKU 291351 **14<sup>99</sup>**  
24246

- Twin Head Suction Cups Help Remove Windshields
- ABS Rubber Cups Grab Hold of Glass
- Flexible Handle Bends to Windshield
- Quick Release Levers for One-Hand Operation



OEM TOOLS®

### 18" Professional Windshield Knife

SKU 480782 **29<sup>99</sup>**  
CAL53100

- Constructed of Heavy Duty Steel and Aluminum with a Padded Ergonomic Handle



Cal-Yan TOOLS

Prices subject to change without notice. Prices do not include applicable taxes, vehicles, tires, rims, installation or optional equipment as shown. Please do not return purchases to the store. For information regarding warranty, repair, or any questions or concerns, call 901-300-4878.

AZG0125

37

# SPECIALTY TOOLS

## Torque Wrenches

### 3/8" Drive (10-80 Ft/Lb.)

SKU 177722 **59<sup>99</sup>**  
25694

### 1/2" Drive (25-250 Ft/Lb.)

SKU 177715 **99<sup>99</sup>**  
25695

### 1/2" Drive (10-150 Ft/Lb.)

SKU 012651 **69<sup>99</sup>**  
25689



OEM TOOLS

### 3/8" Drive Torque Wrench (25-250 In/Lb.)

SKU 133657 **34<sup>99</sup>**  
25685

- 45 Tooth Round Head Ratchet
- Both Clockwise and Counterclockwise Operation



OEM TOOLS

### Click Style Torque Wrench - 3/8" Drive

SKU 133658 **34<sup>99</sup>**  
25686

- Precision Torque Control by 45-Tooth Ratchet Head
- Audible Click When Desired Torque is Reached
- Both Clockwise and Counterclockwise Operation
- High Grade Spring Steel Torque Mechanism

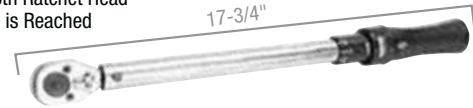

OEM TOOLS

### 3/4" Torque Wrench (50-400 Ft/Lb.)

SKU 1103610 **199<sup>99</sup>**  
37309

Ideal for Replacing Ford F150 Front Wheel Bearings

- Range: 50-400 Ft/Lb. and 84.7-559.2 N-m
- Increments 2.5 Ft/Lb.



OEM TOOLS

### 1/4" Drive Torque Wrench (20-200 In/Lb.)

SKU 954210 **199<sup>99</sup>**  
CEN97361B

- Push Through Square Drive for Reverse Operation
- Reverse Window Laser Marking
- Rubber Over-Mold Lock Ring for Better Grip
- NIST Certified

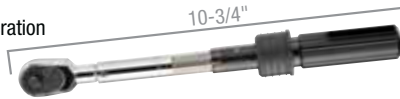

Central TOOLS, Inc.  
QUALITY AND INNOVATION SINCE 1908

### 1/2" Drive Click Style Torque Wrench (25-250 Ft/Lb.)

SKU 133659 **56<sup>99</sup>**  
25687

- Both Clockwise and Counterclockwise Operation

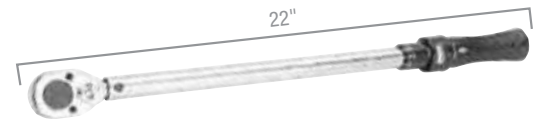

OEM TOOLS

### 3/4" Drive Torque Multiplier

SKU 191056 **299<sup>99</sup>**  
25683

- Increased Torque Output Converts Low Torque (Max. 650 Ft/Lb.) to High Torque (2,200 Ft/Lb., 3000 Nm) with Planetary Gear Set for Heavy Duty Tightening and Loosening
- Input Drive: 3/4"
- Output Drive: 1"

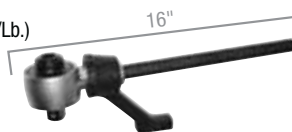

OEM TOOLS

### 3/4" Drive Professional Micrometer Torque Wrench (100-600 Ft/Lb.)

SKU 217376 **299<sup>99</sup>**  
25688

- Right Hand Direction



OEM TOOLS

Micrometer Click Style

## Measuring Tools

### Tire Tread Depth Gauge

SKU 954233 **39<sup>99</sup>**  
CEN3S402A

- Easy-to-Read Digital Display
- Fractional Scale in 1/32" Increments
- Spring-Loaded Plunger



Central TOOLS, Inc.  
QUALITY AND INNOVATION SINCE 1908

### 24" Straight Edge

SKU 949552 **41<sup>99</sup>**  
25355

- Constructed with 1/4" Thick Cold Rolled Steel
- Durable Powder Coat Finish with Precision Ground Edge
- Hang Hole for Convenient Storage
- Includes Reusable Protective Edge



OEM TOOLS



### 6" Electronic Digital Caliper

SKU 864649 **31<sup>99</sup>**  
25363

- Large Easy to Read LCD Display
- Zeroing Feature
- Thumb Roller with Locking Device

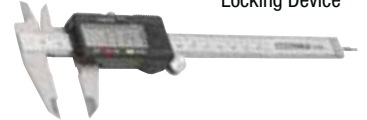

OEM TOOLS

### 1" Dial Indicator Set

SKU 954195 **89<sup>99</sup>**  
CEN3D101

- Strong Magnetic Base
- Revolution Counter
- Full 1" Range



Central TOOLS, Inc.  
QUALITY AND INNOVATION SINCE 1908

### Indicator Set with Flex Arms and Lock Pliers

SKU 954184 **129<sup>99</sup>**  
CEN3D103

- Locking Pliers for Mounting
- Flex Arm for Extra Reach
- Revolution Counter
- Full 1" Range



Central TOOLS, Inc.  
QUALITY AND INNOVATION SINCE 1908

### Extended Range Bore Gauge

SKU 954188 **199<sup>99</sup>**  
CEN3D302

- Extended Range of 1.4" to 6"
- Lower Range for Small Applications
- Reach Deep into Cylinders



Central TOOLS, Inc.  
QUALITY AND INNOVATION SINCE 1908

### 0-5.5" Digital Rotor Gauge

SKU 954197 **89<sup>99</sup>**  
CEN3M430A

- Easy-to-Read Digital Display
- Pointed Anvil for Measuring Grooves
- Inch and Metric Readings



Central TOOLS, Inc.  
QUALITY AND INNOVATION SINCE 1908

### Digital Drum Gauge

SKU 954196 **244<sup>99</sup>**  
CEN3B531

- Depth Stops to Improve Accuracy
- Pointed Anvils for Grooves
- Easy-to-Read Digital Display
- 4" to 20" Range Plus Oversize



Central TOOLS, Inc.  
QUALITY AND INNOVATION SINCE 1908

### 3/8" Drive Digital Torque Adapter

SKU 362559 **49<sup>99</sup>**  
25684

- Range: 19 to 99 Ft/Lb. (27 to 135 Nm)
- Comes in a Sturdy Blow Mold Case



OEM TOOLS

### 25' Tape Measure

SKU 1414409 **19<sup>99</sup>**  
25699

- Two-Sided Blade Printed in Centimeters and Inches
- 1" Extra Wide Blade
- 10" Standout Reach
- Magnetic End with Dual Hooks
- Heavy Duty Impact-Resistant Case



OEM TOOLS

Prices subject to change without notice. Prices do not include applicable taxes, vehicles, tires, rims, installation or optional equipment as shown. Please do not return purchases to the store. For information regarding warranty, repair, or any questions or concerns, call 901-300-4878.

# SPECIALTY TOOLS

TO ORDER, contact your Commercial Sales Manager or go to [AutoZonePro.com](http://AutoZonePro.com)

SPECIALTY TOOLS

## Steck - Lockout Tools

### BigEasy™ Glo with Easy Wedge Lockout Kit

SKU 964494 **99<sup>99</sup>**  
STK32955

- Glow-In-The-Dark Yellow Allows You to See the Tool at Night or Through Tinted Windows
- Easy Wedge Offers Controlled Opening of the Car Door for Inserting the BigEasy Glo



Glow in the Dark

### BigEasy™ Carrying Case

SKU 227873 **39<sup>99</sup>**  
STK32935

- Made of Soft, Yet Firm Material to Protect Your BigEasy Kit
- Custom Pockets for the BigEasy, Non-Marring Wedge, Lock Knob Lifter and Easy Wedge
- Makes it Convenient to Stow Your BigEasy Kit in Your Truck



### BigEasy™ Lockout Kit

SKU 964491 **49<sup>99</sup>**  
STK32900

- High Visibility Pink Powder Coating and Improved Non-Marring Wedge
- Lock Knob Lifter for Cars with Flat Lock Knobs at the Top of the Door
- Paint Protector Reduces Friction Between the Car Door and the BigEasy



### BigEasy™ Easy Wedge (Inflatable)

SKU 964493 **49<sup>99</sup>**  
STK32922

- Inflatable Controlled Opening of Car Door for Insertion of the BigEasy



## Access Tools - Lockout Tools

### Emergency Response Kit Long Case

SKU 1339730 **199<sup>99</sup>**  
AETERKLC

- Most Popular Accessories, Gets into Any Vehicle
- Designed by First Responders
- Emergency Ready
- Includes: Quick Max Long Reach Tool, Flex Max, Button Master, Super One Hand Jack Tool, Super Air Wedge, Glassman Wedge and Button Strip Tool

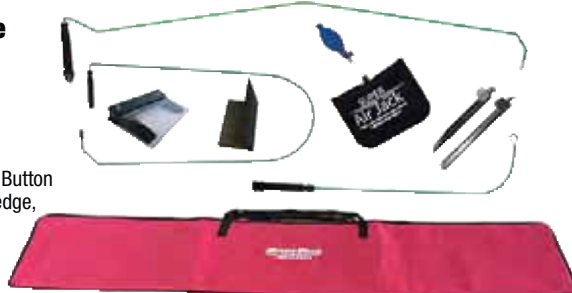

### Button Master

SKU 1189051 **54<sup>99</sup>**  
AETRCBM

- Flexible Coated Long Reach Tool
- Retractable Loop with Grip Cover
- Grab Vertical Door Buttons with Ease
- Approximately 38" in Length When Straightened
- Most Flexible and Versatile Version of All the Button Masters



AccessTools

### One Hand Jack Set

SKU 1145698 **124<sup>99</sup>**  
AETOHJS4

- Easy-to-Use Car Opening Kit
- Soft Shielded Long Reach Tool That Won't Scratch Paint
- Air Wedge with Stiff Insert for Easy Insertion
- Vertical Button Tool One Hand Jack for Quick, Damage-Free Insertion of the Air Jack



## Rivet Tools



### Rivet Tool Kit with 200 Assorted Rivets

SKU 094877 **119<sup>99</sup>**  
MAR39001KIT



### Deluxe Rivet Kit with 200 Stainless Steel Rivets

SKU 094879 **114<sup>99</sup>**  
MAR39003KIT

### Multiplex Hand Riveter and Rivet Nut Setter

SKU 1284961 **89<sup>99</sup>**  
MARM39410

- Innovative Multi-Purpose Tool for Rivets and Rivet Nuts
- Set Blind Rivets Up to 3/16" Diameter, Rivet Nuts Up to 1/4-20 Size



### Industrial Hand Riveter

SKU 291353 **47<sup>99</sup>**  
25921

- For Use with Steel and Aluminum Rivets Noses: 1/8" (3.2 mm), 5/32" (4.0 mm), 3/16" (4.8 mm), 1/4" (6.4 mm)
- 18" Overall Size with Long Handle Provides More Leverage

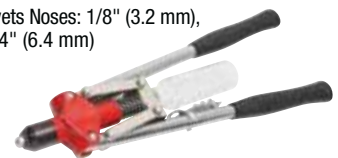

OEM TOOLS

### Big Daddy® Hand Riveter

SKU 094886 **229<sup>99</sup>**  
MAR39031

- Sets Large Diameter Blind Rivets.
- Double Gear Reduction System Easily Sets from 1/8" to 1/4" Diameter Klik-Fast Rivets in All Alloys Including 1/4" Klik-Split® Rivets
- Comes with 5/32", 3/16" and 1/4" Nose Pieces Stored in the Body



### Nut Rivet Set Metric

SKU 94888 **129<sup>99</sup>**  
MAR39303

- Includes the 39200 Thread-Setter Tool with 8-32, 10-32 and 1/4-20 Mandrels and Nosepieces and Wrench
- Contains 44 Assorted Klik Poly-Nuts



See More Marson Rivet Tools on [AutoZonePro.com](http://AutoZonePro.com)

Prices subject to change without notice. Prices do not include applicable taxes, vehicles, tires, rims, installation or optional equipment as shown. Please do not return purchases to the store. For information regarding warranty, repair, or any questions or concerns, call 901-300-4878.

# SPECIALTY TOOLS

## Slide Hammer Pullers

### 5 Lb. Slide Hammer

SKU 1103572 **54<sup>99</sup>**  
37033

- For a Variety of Pulling Tasks
- Chrome Plated Main Shaft
- Thread: 5/8" x 18



### 9 Way Slide Hammer Puller Set

SKU 1335798 **119<sup>99</sup>**  
37191

- Pulls Flange-Type Rear Axles and Most Front Wheel Drive Hubs
- Internal and External Jaws Provide a Variety of Combinations to Pull Bearings, Gears and Seals
- 2-Way and 3-Way Cross Blocks
- Includes: Grip Wrench Adapter and Dent Puller Attachment
- Designed for Use with Other 5/8" x 18 Thread Slide Hammer Attachments

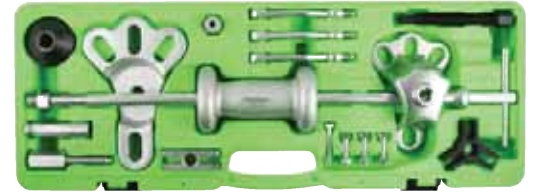

OEM TOOLS®

### Rear Axle Puller Set

SKU 094801 **69<sup>99</sup>**  
27202

- Use for Flange-Type Rear Axle and Bearing Removal on Most Late Model Passenger Cars and Light Trucks
- Slide Rod and Adapters are 5/8" x 18 Standard Threads



### VW/Audi Fuel Injector Puller Kit

SKU 1103636 **59<sup>99</sup>**  
37383

- Includes: 1 Mini Slide Hammer, 1 Installation Tool, 2 Special Puller Attachments and 3 Knurled Collars
- Comes in a Sturdy Blow Mold Case
- Used with All 2.0 L TSI/FSI/TSFI Engines



## Multi-Purpose Puller

### Multi-Purpose Bearing and Pulley Puller Set

SKU 900824 **119<sup>99</sup>**  
27190

- Use on Pitman Arms, Timing Gears, Carrier Side Bearings, Crankshaft Pulleys and More
- 20 Piece Set Includes: 6 Jaws, 2 Bar Housings 6 Bolts and 2 Retainers
- Capacity: 6-10 Tons (Depending on the Jaws)
- Combine to Create 10 Different Pullers



OEM TOOLS®

## Retainer Remover

### Brake Cylinder Retainer Remover

SKU 265111 **14<sup>99</sup>**  
25268

- Expands and Holds Special Retainer So the Brake Cylinder May Be Removed
- Releases the Spring Clip Retainer That Attaches the Rear Brake Cylinder to Backing Plate



OEM TOOLS®

## Lock and Snap Ring Pliers

### Professional Internal/External Snap Ring Pliers

SKU 1340233 **19<sup>99</sup>**  
25097

- Unique Jaw Design Makes it Easy to Switch from Internal to External Configurations
- For Both Internal and External Rings
- Alloy Steel and PVC Grip with Storage for Tips
- Includes: 3 Pairs of Tips and Hex Key, 1 Pair Straight Tips for 1.2 mm and 1.8 mm, 2 Pair 90° Tips for 1.2 mm and 1.8 mm



### Angle Tip Lock Ring Pliers

SKU 191055 **29<sup>99</sup>**  
25354

- For Spreading Snap Rings Found on Brakes, Pedal Shafts, Clutch Shafts, Transmissions, Machine Tools and Piston Rings
- Constructed with Durable Drop Forged Steel Alloy
- Spring-Loaded Jaws Feature a Scored Outside Edge for a Secure Grip
- Vinyl Grip Handles for Added Comfort and Control
- Spread: 3/4"
- Length: 8-1/4"



### 10 Piece Snap Ring Pliers Set

SKU 900819 **74<sup>99</sup>**  
27180

- Includes: (2) 5-1/2" Bent Pliers (0.038" and 0.047" Tip), (2) 6" Straight Pliers (0.038" and 0.047" Tip), 7-1/2" Bent Pliers (0.070" Tip), 8" Straight Pliers (0.070" Tip), 8-1/2" Bent Pliers (0.090" Tip), 9" Straight Pliers (0.090" Tip), 1 Pick Tool and 1 Hook Tool
- For Both Internal and External Rings
- Constructed with Heat-Treated Chrome Moly Steel
- Comes in Sturdy Blow Mold Case



OEM TOOLS®

## 2/3 Jaw Pullers

### 1 Ton Puller

- Standard Jaw Puller Made with Hi-Alloy Steel
- Jaws Grip Tighter as Pressure is Applied
- Adjustable and Reversible Jaws with 2 and 3 Jaw Configuration

**3" Spread**  
SKU 246386 **19<sup>99</sup>**  
25902

**4" Spread**  
SKU 246387 **24<sup>99</sup>**  
25903

**5 Ton**  
SKU 516519 **39<sup>99</sup>**  
27078



25902



25903



27078



OEM TOOLS®

Prices subject to change without notice. Prices do not include applicable taxes, vehicles, tires, rims, installation or optional equipment as shown. Please do not return purchases to the store. For information regarding warranty, repair, or any questions or concerns, call 901-300-4878.



## Cam/Crankshaft Tools

### Crank Bolt Sockets

Deep Counter-Weighted Sockets Provide Increased Torque to Break Loose Stubborn Crank Bolts

- Applications: Honda-Acura, Models: Accord, Civic, Pilot, CRV, Odyssey, CL TL Integra, MDX, Vehicles. Plus Toyota-Lexus, Models: Camry, Corolla, 4Runner, Sequoia, ES300, LS400 Vehicles and More

**17 mm**  
SKU 912348 **19<sup>99</sup>**  
25275

**19 mm**  
SKU 1335801 **19<sup>99</sup>**  
25290

**21 mm**  
SKU 912343 **19<sup>99</sup>**  
25273

**22 mm**  
SKU 070132 **19<sup>99</sup>**  
25300

**26 mm**  
SKU 919500 **19<sup>99</sup>**  
25278

**27 mm**  
SKU 919497 **19<sup>99</sup>**  
25279



### 6 Piece Crank Bolt Socket Set **OEM TOOLS**

SKU 919501 **99<sup>99</sup>**  
25276

- Includes: 17, 19, 21, 22, 26 and 27 mm Deep Counter-Weighted Sockets
- Provides Increased Torque to Break Loose Stubborn Crank Bolts
- Applications: Honda-Acura, Models: Accord, Civic, Pilot, CRV, Odyssey, CL TL Integra, MDX, Vehicles. Plus Toyota-Lexus, Models: Camry, Corolla, 4Runner, Sequoia, ES300, LS400 Vehicles and More
- Constructed with Durable Chrome Moly Steel

### Universal Pulley and Fan Clutch Holder **OEM TOOLS**

SKU 547013 **64<sup>99</sup>**  
27281

- Fits Many Different Fan Clutches, Cam and Crank Pulleys with Slots or Holes Adjustable Diameter: 1-1/2" to 8-5/8" Pin Sizes: 6-10 mm, 8-11 mm, 10-12 mm and 11-16 mm
- Comes in Blow Mold Case

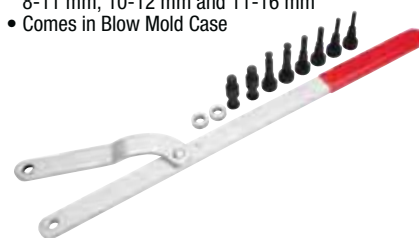

### 5 Piece Master Cam/Timing Gear Clamp Set **OEM TOOLS**

SKU 383452 **24<sup>99</sup>**  
27210

- Covers Most Single, Twin Cam and Quad Cam Engines
- Locks Camshaft to Hold Valve Timing During Timing Belt Replacement



### 2 Piece Timing Gear Holder Set

SKU 238159 **19<sup>99</sup>**  
24360

### Ford Cam Tool 1.6 Liter **OEM TOOLS**

SKU 1103640 **29<sup>99</sup>**  
37380

- Designed to Hold the VCT Sprockets in Position During Timing Belt Installation or Camshaft Service
- Alignment Tool Services: Ford Fiesta (2011 to 2014), Ford Escape (2013 to 2014), Ford Fusion (2013 to 2014), Ford Transit (2013 to 2014)



### Ford 2.0 L, 2.3 L, 2.5 L Cam Tool Kit **OEM TOOLS**

SKU 626108 **14<sup>99</sup>**  
24448

- Applications: 2.0 L DOHC Engines Found in Ford and Mercury (1994 to 2003), 2.5 L DOHC, 2.3 L DOHC 4V and 2.0 L DOHC Engines in Ford, Mercury and Mazda (2004 to 2012) and 2.0 L DOHC Engines in Ford Probe (1993 to 1994)



### Ford Timing Chain Locking Wedge Tool **OEM TOOLS**

SKU 012647 **19<sup>99</sup>**  
24207

- For 2005-14 5.4 L and 4.6 L 3V OE Type Tool Allows for Easy Cam Changes without Removing the Timing Cover
- Compact and Easy to Use
- OE Type Tool
- For 5.4 L and 4.6 L 3V (2005-2014)



### DOHC Cam Lock Holder

SKU 291419 **54<sup>99</sup>**  
LIS36880

- This Versatile Tool Easily Locks and Holds Both Camshaft Sprockets Firmly in Place
- Preserves the Engine Timing During Belt or Chain Replacement

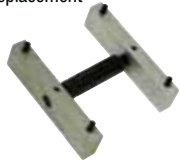

### Pilot Bearing Puller **OEM TOOLS**

SKU 775523 **22<sup>99</sup>**  
25089

- Use to Pull Pilot Bearing from End of Crankshaft
- Plate Prevents the Jaws from Spinning When Force is Applied
- Spread Range: 1/2" to 1-1/2"
- Reach Range: 3/16" to 11/4"



### Pilot Bearing Puller Attachment **OEM TOOLS**

SKU OUTSIDE BUY/EPO **18<sup>99</sup>**  
27059

- Use with OEMTOOLS 37033 and 27202 Slide Hammer Pullers
- Threaded with Both 5/8" x 18 and 3/4" x 16 Threads to Fit Most Slide Hammers



For Outside Buy/EPO, Call 901-300-4878

### Ford Master Timing Kit

SKU OUTSIDE BUY/EPO **259<sup>99</sup>**  
CTA2221

- Includes: Harmonic Balancer Holder, Camshaft Alignment Tool, VCT Alignment Tool, Crankshaft Positioning Tool, Crankshaft Vibration Damper Alignment Tool, 3 Pc. Wedges and Camshaft Timing Kit
- Services Ford, Mazda and Lincoln 1.4 L, 1.5 L, 1.6 L, 2.0 L, 2.3 L, 2.5 L, 3.0 L and 3.5 L Engines



For Outside Buy/EPO, Call 901-300-4878

### Flywheel Turner **OEM TOOLS**

SKU 1207891 **19<sup>99</sup>**  
25556

- Holds Flex Plates and Fly Wheels to Allow Clutch, Transmission and Crankshaft Service
- Spring Tensioned to Keep the Wrench Securely Engaged
- Sure Grip Handle



### Flywheel Locking Tool **OEM TOOLS**

SKU 1335793 **27<sup>99</sup>**  
25557

- Locks Flywheel in Place When Removing Harmonic Balancer on 6.6 L Duramax Engines with Allison Automatic Transmissions
- Saves Time by Securing the Flywheel at the Transmission as an Alternative of Having to Remove the Starter for Water Pump Replacement
- Use 36 mm 12 Point Socket with 3/4" Square Drive to Remove Harmonic Balancer Bolt and Retorque on Installation
- Toothed Pieces with Screws Work with Duramax 4500/5500 Trucks



### Universal Camshaft Bearing Tool **OEM TOOLS**

SKU 191677 **199<sup>99</sup>**  
27143

- Removes or Inserts Camshaft Bearings in Nearly All Engines
- Set Includes: Driving Shaft, Driving Shaft Extension, Expander Unit, 5 Split Driving Plugs, 2 Driving Collars and Centering Cone
- Easy on Bearings
- Range: 1.125" to 2.69"



# ENGINE SERVICE

## Valve & Cylinder Head Tools

### Combustion Leak Detector

SKU 1103608  
37145 **29<sup>99</sup>**

- Test for Internal Combustion Leaks on Gasoline Engines
- Fluid Color Changes to Yellow When a Combustion Leak is Present
- Comes in a Sturdy Blow Mold Case
- Not for Use with Diesel Engines



### Combustion Leak Detector Fluid (8 Oz.)

SKU 391381  
25739 **9<sup>99</sup>**



**STORE STOCKED**

### Flexible Air Valve Holder

SKU 1392465  
25029 **16<sup>99</sup>**

- For 14 mm and 18 mm Spark Plug Holes
- 14" Flexible Hose Reaches into Tight Areas



### Valve Keeper Remover and Installer Kit

SKU 011658  
LIS36050 **109<sup>99</sup>**

**Makes Valve Component Disassembly and Reassembly Fast and Easy**

- For Use with Valve Stems from 4.5 to 7.5 mm and 5/16" to 3/8"
- Magnet in Tool Body Captures Keepers
- New Smaller Size Works on Toyota 4 Cylinder and Chrysler New World Engine



### Lever Valve Spring Compressor

SKU 662780  
24676 **59<sup>99</sup>**

- Lever Action Stays Compressed for Easy Valve Lock Removal
- Included Adapters Fit Valve Retainer Diameters from 1" (25 mm) to 1-3/16" (30 mm)
- Compression Range from 1-3/8" to 5-5/8" (35 mm to 142 mm)



### Push Rod Remover

SKU 459100  
LIS48300 **29<sup>99</sup>**

- Redesigned for Newer 3.5 L and 3.6 L GM Engines - Also Works on GM V6 2.8L, 3.1 L and 3.4L
- Quickly Removes Push Rods to Replace the Intake Gaskets without Removing Rocker Arms



### Torque Adapter, Diesel Head Bolt, Ford 6.0 L Power Stroke® Engines

SKU 298191  
24208 **18<sup>99</sup>**

- Eliminates the Need to Remove the Truck/Van Cab from the Chassis to Access the Rear Head Bolts
- Eliminates the Need to Remove the Evaporator Housing, Saving 2 Hours of Time and the Additional Cost of Refrigerant Added During A/C Recharging
- Prevents Damage to the Rear Heat Shield
- Use with OEMTOOLS® 27309 3/4" Drive Torque Wrench and OEMTOOLS® 22398 18 mm Socket



### Ford Valve Spring Compressor

SKU 626111  
24434 **24<sup>99</sup>**

- Applications: 1991 to 2004 Ford Vehicles with 4.6 L, 2V, V8 Engines; 4.6 4V, 5.4 V8 and 6.8 V10
- Works with Engine Removed or Installed, Cylinder Head On or Off
- Not for Triton 5.4 3V



### Ford Valve Spring Compressor for 3-Valve Engines

SKU 814391  
24429 **42<sup>99</sup>**

- Designed to Compress the Valve Spring without Removing the Camshaft While Servicing the Cylinder Head in Ford 3-Valve Engines
- For Use with Ford 3-Valve 4.6 L and 5.4 L Engines



### 24" Straight Edge

SKU 949552  
25355 **41<sup>99</sup>**



- Use with a Feeler Gauge to Inspect for Distortion on Engine Blocks, Cylinder Heads, Fly Wheels, Main Bearing Saddles, Cam Bearing Saddles, Cam Covers and Bell Housings
- Constructed with 1/4" Thick Cold Rolled Steel
- Precision Ground Edge to +/- 0.001"
- Durable Powder-Coat Finish
- Hang Hole for Convenient Storage
- Includes Reusable Protective Edge



## Engine Cylinder Hones

### BC 180SC Flex-Hone Tool Kit

SKU 213154  
BRM14353 **239<sup>99</sup>**

- 10 Piece Kit Features Flex-Hone Sizes: 10 mm, 1/2", 5/8", 3/4", 7/8", 1", 1-1/4", 1-1/2", 1-3/4" and 2"
- Complimentary Snap Back Hat, 1/2 Pint of Flex-Hone Oil and 1GB Flash Drive



SKU	Part #	Product	Cylinder Diameter		Price
			Metric	SAE	
341226	BRMBC30018	Flex-Hone™ GB	76 mm	3"	<b>54.99</b>
341232	BRMGB31412	Flex-Hone™ GB	83 mm	3-1/4"	<b>54.99</b>
341239	BRMGB31212	Flex-Hone™ GB	89 mm	3-1/2"	<b>59.99</b>
341317	BRMGB33412	Flex-Hone™ GB	95 mm	3-3/4"	<b>64.99</b>
341325	BRMGB41812	Flex-Hone™ GB	105 mm	4-1/8"	<b>69.99</b>
341332	BRMGB45812	Flex-Hone™ GB	118 mm	4-5/8"	<b>69.99</b>

**ADDITIONAL SIZES AVAILABLE - CALL US AT 901-300-4878 OR VISIT AZTOOL1.COM**

**OEM TOOLS®**  
MADE FOR MECHANICS

# THE SPECIALTY TOOLS YOU NEED



## Harmonic Balancer Tools

OEM TOOLS

### Harmonic Balancer Puller Kit

SKU 818738 **39<sup>99</sup>**  
25090

Unique Jaw and Returning Springs for Easy Positioning of the Puller

- Includes: Puller Body, 3 Jaw Puller, 3 Jaw Retaining Pins, 3 Wave Washers, Pressure Screw
- Insert Rods: 4", 5-13/32", 6-1/2" and 7-13/32"
- Used on Many GM, Ford, Mitsubishi and Chrysler Engines



### Harmonic Balancer Puller

OEM TOOLS

SKU 1103576 **24<sup>99</sup>**  
37187

- Includes: Yoke, Pressure Screw and Pulling Screws
- Floating Swivel Prevents Damage to Shaft Ends
- Ideal for Any Shop or Garage
- Pulling Balancers and More
- Heat-Treated for Strength and Durability

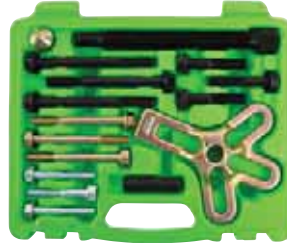

### Long Reach Harmonic Balancer/Pulley Installer for GM, Ford and Chrysler

OEM TOOLS

SKU 1103550 **44<sup>99</sup>**  
37306

- Use to Install Crank Pulley or Underdrive Pulley on Many Late Model Ford, GM, Dodge and Chrysler Vehicles with V8 and V6 Engines
- Includes: M16 x 2.0 mm (GM), M14 x 1.5 mm (Dodge, Chrysler and Jeep), M12 x 1.75 mm (Dodge Chrysler and Jeep) and M12 x 1.5 mm (Ford)



### Universal Pulley and Fan Clutch Holder

OEM TOOLS

SKU 547013 **64<sup>99</sup>**  
27281

- Fits Many Different Fan Clutches, Cam and Crank Pulleys with Slots or Holes
- Adjustable Diameter: 1-1/2" to 8-5/8"
- Pin Sizes: 6-10 mm, 8-11 mm, 10-12 mm and 11-16 mm
- Comes in Blow Mold Case



### Harmonic Balancer Installer

OEM TOOLS

SKU 1103603 **39<sup>99</sup>**  
37144

- Use to Properly Install Harmonic Balancers without Damage
- Thread Adapters: 12 mm x 1.5, 14 mm x 1.5, 16 mm x 2.0, 7/16" x 20, 1/2" x 20, 9/16" x 18, 5/8" x 18, 3/4" x 16

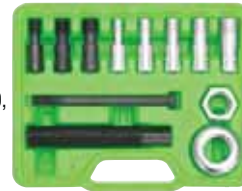

### GM Harmonic Balancer Puller

OEM TOOLS

SKU 213102 **59<sup>99</sup>**  
25264

Time Saving Tool, No Need to Remove Radiator

- Designed to Remove Harmonic Balancers without Tapped Holes
- GM Applications: 5.3 L, 5.7 LS1, 6.0 LS2, 6.2 LS3, 7.0 L
- Chrysler/Jeep/Dodge: 3.5 L V6, 3.6 L V6, 4.7 L V8, 5.7 L V8 and 6.1 L V8



### Flywheel Locking Tool

OEM TOOLS

SKU 1335793 **27<sup>99</sup>**  
25557

- Locks Flywheel in Place When Removing Harmonic Balancer on 6.6 L Duramax Engines with Allison Automatic Transmissions
- Saves Time by Securing the Flywheel at the Transmission as an Alternative of Having to Remove the Starter for Water Pump Replacement
- Use 36 mm 12 Point Socket with 3/4" Square Drive to Remove Harmonic Balancer Bolt and Retorquing on Installation
- Toothed Pieces with Screws Work with Duramax 4500/5500 Trucks



### 2.7/5.2 L Ford EcoBoost Long Reach Harmonic Balancer/Installer

Cal-Yan Tools

SKU 1392336 **49<sup>99</sup>**  
CAL38710

- Designed to Achieve Easy Installation of Harmonic Balancers on Ford EcoBoost
- Can Be Used On 2.7 L, 3.0 L, 3.3 L and 5.0 L Engines in Ford/Lincoln Cars, Trucks and SUV



### Ratcheting Harmonic Balancer Pulley Puller

Cal-Yan Tools

SKU 1189050 **89<sup>99</sup>**  
CAL38000

- Eliminates Need to Remove the Radiator
- Push Turn Click Design
- No Need for Bolts
- Applications: FORD 5.0 Coyote, GM 5.3 L, 5.7 (LS1), 6.0 (LS2), 6.2 (LS3), 7.0 L and Most Three and Six-Spoke Harmonic Balancers/Pulleys



## Hex Oil Pump Primers

OEM TOOLS

- Used to Prime the Lubricating System of a Rebuilt Engine Prior to the First Start, Preventing a Dry Start
- Connects to the Oil Pump Shaft Through the Distributor Hole
- For Use with 3/8" Reversible Drill



**Ford 5/16"**  
SKU 534545 **14<sup>99</sup>**  
27062

**Ford 1/4"**  
SKU 534537 **29<sup>99</sup>**  
27061

## Piston Tools

### Piston Ring Compressor

SKU 013641 **14<sup>99</sup>**  
24682

- 1-1/2" Deep, Low Friction Wrinkle Band
- Fits 3" to 5" Pistons



OEM TOOLS

### Piston Ring Expander Pliers

SKU 003509 **22<sup>99</sup>**  
25083

- Eliminates Piston Ring Damage and Distortion During the Installation and Removal Process Dipped Rubber Handles for Improved Grip
- Diameter Range: 3-1/8" (80 mm) to 4-5/8" (120 mm)



# ENGINE SERVICE

## Diagnostic

### Compression Tester Gauge Set

SKU 1103601  
37138 **29<sup>99</sup>**

- Use to Test Compression 0 to 300 psi on 14 mm and 18 mm Spark Plug Ports and Determines Engine Mechanical Condition



### 8 Piece Noid Light Set

SKU 1103589  
37161 **24<sup>99</sup>**

- Includes: GM TBI, GM SCPI, GM PFI, Ford TBI, GEO TBI, Bosch PFI, Bosch Type 2 and GM Multec 2
- See-Through Design to Check Electrical Pulses

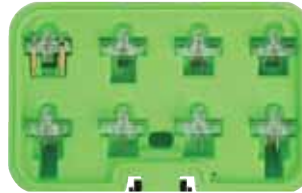

### Vacuum Pump Tester Power Steering and Brake Bleeder Set

SKU 1103570  
37070 **39<sup>99</sup>**

- Brake Bleeding Kit Bleeds Brakes, Clutches or Other Hydraulic Systems
- Kit Includes: Vacuum Pump Reservoir Jar with Transfer Lid, Storage Lid, Brake Bleeding Adapter Package, Steering Pump Adapters and Tubing



### Exhaust Back Pressure Tester/Gauge

SKU 1103604  
37263 **54<sup>99</sup>**

- Oxygen Sensor Adapter is M12 and M18 Thread
- 6' Hose Allows User to Test from Driver's Seat
- Test for Restricted Exhaust Systems



### Gas Engine Combustion Leak Tester

SKU 1103608  
37145 **29<sup>99</sup>**

- Test for Internal Combustion Leaks on Gasoline Engines
- Fluid Color Changes to Yellow When a Combustion Leak is Present
- Designed for Professional Auto Mechanics and Heavy Duty Applications
- Not for Use with Diesel Engines
- Use with 25739 Test Fluid



## Alternator Tools

### Alternator Decoupler Pulley Tool Kit

SKU 300124  
27261 **19<sup>99</sup>** REG. \$24.99

- Works on Both Overriding Alternator Decoupler (OAD) and One-Way Clutch (OWC) Pulleys
- Tools May Be Used While the Alternator is On or Off
- Includes 2 Pulley Sockets and 3 Shaft Bits
- Comes in a Sturdy Blow Mold Storage Case



Offer Good Through March 31, 2025

**SAVE \$5**

### Alternator Decoupler Pulley Service Set

SKU 1103629  
37275 **39<sup>99</sup>**

- Removes and Installs Many Alternator Decoupler Pulleys on the Most Popular Vehicles
- Works on Both Overriding Alternator Decoupler (OAD) and One-Way Clutch (OWC) Pulleys

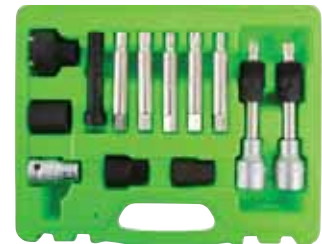

## Exhaust Tools

### 1-1/2" x 2-7/16" Tailpipe Expander

SKU OUTSIDE BUY/EPO  
27027 **24<sup>99</sup>**

- Extra Long Hex Bar for Convenience



For Outside Buy/EPO, Call 901-300-4878

### Exhaust Manifold Spreader Set

SKU 504028  
25253TWO **18<sup>99</sup>**

- Use for Reinstalling the Manifold on Small-Block Chevrolets
- Simple Way to Expand Warped Manifold to Align Bolt Holes
- Helps Prevent Cross-Threading of Manifold Bolts
- Works Best When Used in Pairs or Install Before Removing Manifold to Prevent Misalignment



### Manifold Drill Template - Ford 2V and 3V

SKU 213145  
25251 **69<sup>99</sup>**

- Designed to Remove Broken Exhaust Manifold Studs
- For Ford Triton 2V and 3V Engines - 4.6L, 5.4 L and 6.8 L V10
- Drill Depth Gauge Marked on Each Adapter
- Interchangeable 2V and 3V Adapters
- Hi-Vis EVA Tray for Easy Storage and Organization
- Includes: Template, 2V Adapter, 3V Adapter, 2 Stud Alignment Pins, 3/16" and 1/8" Double-Sided Drill Bits and Stud Extractor



### Exhaust Pipe Stretcher Kit

SKU 080137  
LIS17350 **339<sup>99</sup>**

- Expands All Types of Exhaust Pipe, Including Stainless Steel, from 1-5/8" to 4-1/4" in Size
- Use with Impact Wrench to Quickly Stretch Pipes



### Exhaust Donut Stretcher

SKU 390901  
25543 **15<sup>99</sup>**

- Easily Grabs onto Mounting Rubber Rings or Doughnut Used on Many Exhaust Systems
- Features an Offset J-Hook
- Large Coated Handle for Comfort



### Manifold Drill Template for GM EcoTec3 5.3 L and 6.2 L

SKU 1125865  
LIS71650 **169<sup>99</sup>**

- Removes Broken Exhaust Manifold Bolts without Damaging the Cylinder Head
- Tapered Bolts Allow You to Move from Hole to Hole without Moving Base Plate
- Screw Extractor Removes Broken Bolts
- Includes Bushing Drill Guide When Extractor Cannot Be Used



**This Kit is the Only True, Long Term Repair for Ford Cam Phaser Noise on the Market**



**Stop Saying "No" to Business and Be Confident Your Customers Will Be Satisfied!**

Cam phaser knock on 4.6/5.4 L 3V engines is common in older models and can lead to bigger problems if not fixed. There are millions of trucks on the road with this problem, but until now, there have been few good options to permanently help fix the knock. This kit helps to eliminate any knocking noise heard from the front valve cover/timing cover related to the phasers. These all-in-one kits correct the cam phaser knock on ONE engine.



**Cam Phaser Noise Repair Kits Include:**

- Wedge Tool for Easier Installation
- Programmer with OBD-II Cable
- 2 OEM Quality Phaser Bolts
- 2 Lock Outs

**Ford Cam Phaser Noise Repair Kit**

SKU **OUTSIDE BUY/EPO** **699<sup>99</sup>**

LMEF1503V

- Fits Ford OEM Cam Phaser

Ford, Livernois and logos featured or referred to on this page are the property of their respective trademark holders | For Outside Buy/EPO, Call 901-300-4878

**Fan Clutch Tools**



**BMW Cooling Fan Wrench Set**

SKU 912340 **19<sup>99</sup>**  
25100

- One Tool Holds the Water Pump Pulley in Place
- 32 mm Wrench Features Dipped Rubber Handle for Improved Grip
- 32 mm Ultra-Slim Specialty Wrench is Used to Loosen the Radiator Fan Nut
- Water Pump Pulley Holder is Outfitted with Multiple Holding Points to Fit a Variety of BMW Vehicles

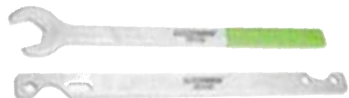

**Fan Clutch Wrench Set**

SKU 1103596 **59<sup>99</sup>**  
37141 REG. \$79.99

**SAVE \$20**

- Works on Many of the Ford, Mazda, Dodge, Lincoln, Mercury and Jeep Makes and Models with the Original Fan Clutch Assembly
- Includes Wrench Sizes: 40 mm, 48 mm, 54 mm, 68 mm, 72 mm, 76 mm and 83 mm



Offer Good Through March 31, 2025

**Universal Fan Wrench Set**

SKU 080554 **89<sup>99</sup>**  
LIS43600

- A Nearly Universal Fan Clutch Wrench Set for Use on the Most Popular Applications
- Hooked Wrench Design Holds Nuts and Bolts, Allowing the Technician to Easily Tighten/Loosen the Other Bolts
- Double-Sided Spanner Style Holding Wrench Will Hold Pressed-On Pulleys on Many GM, Jeep and Dodge Vehicles



**Pneumatic Fan Clutch Wrench Set**

SKU 291409 **219<sup>99</sup>**  
LIS43300

- Quickly Removes and Installs Fan Clutch When Repairing the Water Pump or Fan Clutch
- Includes Wrench Sizes: 32 mm, 36 mm, 40 mm; 7/8", 1-7/8" and 2"



**Pulley and Fan Clutch Holders**

**Fan Clutch Holding Tool**

SKU 209526 **49<sup>99</sup>**  
27171

- For Fan Clutch Repair and Service
- Holds Water Pump Pulley while Servicing Fan Clutch Adjustable Jaws
- Fits Most Water Pump Pulley Bolt Patterns, Including Pressed-On Pulleys
- Jaws Will Lock in Place, Securing Water Pump Bolts
- Longer Handle Provides Leverage for Extra Torque



**Universal Pulley and Fan Clutch Holder**

SKU 547013 **64<sup>99</sup>**  
27281

- Fits Many Different Fan Clutches, Cam and Crank Pulleys with Slots or Holes
- Adjustable Diameter: 1-1/2" to 8-5/8"
- Pin Sizes: 6-10 mm, 8-11 mm, 10-12 mm and 11-16 mm
- Comes in Blow Mold Case



**Stretch Belt Tools**



**Stretch Belt Installation Tool**

SKU 227301 **18<sup>99</sup>**  
24363

- Works on Both Large and Small Pulleys
- Clamping Jaw Allows User to Position Serpentine Belt without the Belt Slipping Out of the Tool



**Stretch Belt Remover and Installer**

SKU 255866 **34<sup>99</sup>**  
LIS59370

- Unique Magnetic Faces Hold the Tool in Place on the Pulley
- Compact, One Piece Tool Can Be Used on the Front or Back Side of the Pulley



# CHASSIS & SUSPENSION

## Ball Joint Service Kits

### XL C-Frame Ball Joint Press Set

SKU 1142924 **109<sup>99</sup>**  
25105

- Ideal for Pressing Out Larger Ball Joints on Pick-Up Trucks: Toyota Tacoma and Tundra, Chevrolet 2500-3500 and Tahoe, Dodge Ram 2500-3500 and Ford F350-F550
- Extended C-Frame Allows Use of Multiple Larger Adapters That Standard C-Frame Presses Won't Fit
- C-Frame Constructed with Heavy Duty Forged Steel for Strength and Durability
- For Use with OEMTOOLS® Ball Joint Press Kits and Adapter Sets



### 74 Piece Master Ball Joint Press Kit

SKU 1207895 **799<sup>99</sup>**  
37388

- Adapters for Almost Every Car, Van, SUV and Light Duty Truck
- Comprehensive Kit with 70+ Adapters and C-Frame
- Tough Heavy Duty C-Frame is Built to Last
- 2 Heavy Duty Molded Cases are Designed for Storage and Mobility



OEMTOOLS®

Easy to Read Manual for Finding Adapters Quickly and Easily



**BONUS**  
VALUE: \$79.99

### Hydraulic Ball Joint Separator

25219

With Purchase of: 37388



Offer Good While Supplies Last Through March 31, 2025

### 21 Piece Master Ball Joint Press Set

SKU 1142406 **124<sup>99</sup>**  
25104

- Removes and Replaces Press-Fit Upper and Lower Ball Joints on 2-Wheel Drive (2WD) and 4-Wheel Drive (4WD) Vehicles
- Includes Adapters with Specialized Cut-Outs to Maneuver Around Obstructions
- Includes Adapters Needed for Removing Upper and Lower Ball Joints on GM, Ford and Chrysler 2WD and 4WD Light-Duty Trucks, Vans and SUVs
- Heavy Duty Forged Steel Alloy C-Frame for the Toughest Jobs — Ideal for Seized Joints



### Master Ball Joint Installer/Remover Adapter Set

SKU 1103612 **87<sup>99</sup>**  
37310

- Includes All the Receiver Tubes and Removing/Installing Adapters Needed to Work on Many GM, Ford and Chrysler 2 and 4 Wheel Drive Pick-Ups, Vans and SUVs
- Works on Press-Fit Upper and Lower Ball Joints
- For Use with OEMTOOLS® Ball Joint Press Kits and Adapter Sets



### Ball/U-Joint Press with 4WD Adapter Set

SKU 1103607 **87<sup>99</sup>**  
37089

- Remove and Replace Ball Joints on Many Vehicles
- C-Clamp Frame Press Also Removes and Replaces U-Joints
- Includes Adapters to Service 1/2 to 3/4 Ton 4 Wheel Drive Vehicles Equipped with Dana 44 Series Front Axle



## Ball Joint Tools

### Ball Joint Separator

SKU 1340232 **29<sup>99</sup>**  
37308

- Used for Separating the Ball Joint from the Spindle Support Arm on Domestic and Import FWD Vehicles
- Adjustable for Different Size Ball Joints
- Max. Opening Range: 1-1/8" to 2-1/8"



### Low Profile Ball Joint Separator

SKU 1245676 **44<sup>99</sup>**  
25112

- Designed for Tight Access Where Many Ball Joint Separators Won't Fit
- For 2005+ Ford, Lincoln and Mercury Applications
- Impact Rated



### Polaris ATV Ball Joint Tool

SKU 1142310 **49<sup>99</sup>**  
24683

- For Removal and Installation of Upper and Lower Ball Joints on Sportsman XP, RZR and Ranger ATVs



OEMTOOLS®

### Hydraulic Ball Joint Separator

SKU 177718 **79<sup>99</sup>**  
25219

- Hydraulic Ram Rated to 8 Tons
- Jaw Capacity: 56 mm (2.25")
- Jaw Width: 22 mm (0.86")

Fast. Safe. Efficient.



### Ball Joint Separator

SKU 1207880 **22<sup>99</sup>**  
26553

- Separate Ball Joints from Spindle Support Arm
- Adjustable for Different Size Ball Joints
- Max. Opening Range: 1-1/8" to 2-1/8"
- Fork Opening Measures 7/8"
- Steel Construction with Black Oxide Pins
- Comes in a Sturdy Blow Mold Case



### 3/4" Drive Ball Joint Impact Socket 2-9/64"

SKU 462494 **14<sup>99</sup>**  
24215

- Used on Chrysler/Dodge Cars, Light Trucks and Vans

### 3/4" Drive Ball Joint Impact Socket 1-59/64"

SKU 662809 **14<sup>99</sup>**  
24238

- Used on Chrysler/Dodge Mid-Size Cars, Light Trucks and Vans



# CHASSIS & SUSPENSION

TO ORDER, contact your Commercial Sales Manager or go to [AutoZonePro.com](http://AutoZonePro.com)

CHASSIS & SUSPENSION

## Spring Compressors

### Floor Mounted Strut Compressor

SKU 1405961 **299<sup>99</sup>**  
37037

- 2,200 Lb. Capacity
- Easy-to-Adjust Bracket Conforms to Spring Rate and Diameter
- Handles Spring Coils 3.5" to 8.75" and Up to 5/8" Diameter
- Max. Spring Height: 19"
- Can Be Securely Mounted to the Floor

No Special Adapters Required

Floor Mounting Hardware Not Included

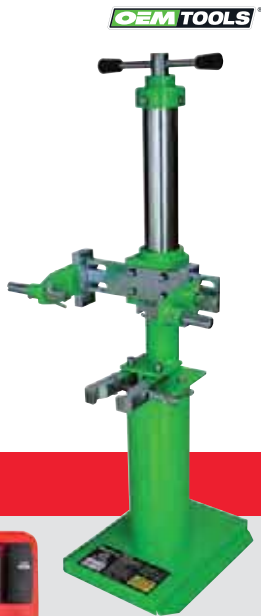

**BONUS** VALUE: \$84.99

### 6 Pt. Axle Nut Socket Set (9 Piece)

27188

With Purchase of: 37037

Offer Good While Supplies Last Through March 31, 2025



### Model 7600 Strut Spring Compressor

SKU 547959 **1,299<sup>99</sup>**  
BRA7600

- Handles the Toughest Applications
- Min./Max. Spring Diameters: 3.5"/11.5"
- No Adapters Required

OEM Approved by Major Automakers

### Cart for BRA7600

SKU 547960 **599<sup>99</sup>**  
BRA00-0137

### Bench Mount for BRA7600

SKU 547962 **129<sup>99</sup>**  
BRA05-0125



### Mechanical Strut Compressor

SKU OUTSIDE BUY/EPO **QSPMSC-1000**

Call for Price

- Designed to Handle Any Size Spring and Strut Assembly
- Adjustable Extra Strong Clamps for a Perfect Grip
- Top Mounted Tool Tray
- Standard Wall Mount
- Safety Guard Included
- Optional Floor Mount and Third Hand Support Kits



For Outside Buy/EPO, Call 901-300-4878

### Coil Spring Compressor

SKU 1103643 **49<sup>99</sup>**  
37035

- Use to Safely Compress the Coil Spring on Most Cars and Light Trucks
- Can Also Be Used When Installing Coil Spring Spacers



### Coil Spring Compressor Set

SKU 1103614 **29<sup>99</sup>**  
37200

- Forged Construction for Strength and Durability
- Removes and Installs Coil Springs Quickly and Safely
- Compresses Coil Springs on Most Passenger Cars and Pickup Trucks



### Strut Spring Compressor

SKU 1207884 **39<sup>99</sup>** REG. \$49.99  
37036

SAVE \$10

- Used to Compress Strut Springs During Cartridge Replacement
- Safety Latches Lock Spring in Place During Compression Hooks are Forged and Center Screw is Hardened for Longer Life
- Thread Length: 9"
- Can Be Used with Varying Coil Diameters Up to 5/8"



Offer Good While Supplies Last Through March 31, 2025

## Suspension

### GM Upper Control Arm Knock Out Tool

SKU 420336 **22<sup>99</sup>**  
24210

- Services Chevrolet and GMC 1/2, 3/4 and 1 Ton, 2 and 4 Wheel Drive Trucks (1989 to 2001) and All Wheel Drive Chevrolet Astro and GMC Safari Vans (1990 to 2002)



## Shock Socket

### Volvo Shock Retaining Nut Strut Removal Socket Tool

SKU 300125 **19<sup>99</sup>**  
24365

- Remove and Install Top Shock Retaining Nut on Volvo Models
- Applications Include: Volvo C70 (1999-2004), Volvo S40 (2000-2004), Volvo S60 (2001-2004), Volvo S70 Non-Turbo (1999-2000), Volvo S70 Turbo (1999-2000), Volvo S70 AWD Turbo (1999-2000), Volvo S80 (1999-2004), Volvo S80 V8 (2007-2008), Volvo S80 Turbo (1999-2006), Volvo V40 (2000-2004), Volvo V70 (1999-2007), Volvo XC90 (2003-2010)



## Front End Service Kit

### 5 Piece Front End Service Kit

SKU 1267952 **76<sup>99</sup>**  
26554

- Large and Small Pitman Arm Puller for Ball Joint Application
- Two Ball Joint Separators
- Three Tie Rod Pullers



## Torsion Bar Tool

### GM, Ford, Chrysler Torsion Bar Tool

SKU 1103600 **49<sup>99</sup>**  
37278

- Safely Loads and Unloads 5-Lug, 6-Lug and 8-Lug GM, Dodge and Ford Torsion Bar Suspensions for Key Replacement
- Extended Long Reach "C-Clamp" for Use with 2011 and Higher GM Heavy Duty Trucks
- Includes Ford/Dodge Adapter



Prices subject to change without notice. Prices do not include applicable taxes, vehicles, tires, rims, installation or optional equipment as shown. Please do not return purchases to the store. For information regarding warranty, repair, or any questions or concerns, call 901-300-4878.

AZG0125

47

# CHASSIS & SUSPENSION

## Hub Bearing

### Front Hub Service Set

SKU 1204178  
68928

- Removes Front Hubs, Drums and Brake Rotors without Damaging the Wheel Bearing
- Fits Most Domestic and Import Vehicles with Independent Front Wheel Suspension
- Jaws Spread Up to 14" with a 5" Reach
- Forged Frame Is Rated to 7 Tons
- Includes Sturdy, Green Blow Mold Case



**149<sup>99</sup>**

REG. \$167.98

**SAVE OVER \$17**

When You Buy the Kit

### Wheel Hub Removal Tool

SKU 1245618  
25749 **69<sup>99</sup>** REG. \$86.99

**SAVE \$17**

- Ideal For Removing a Frozen Hub Assembly without Damaging the Axle
- For Use on Many Axle Bolted Hubs Including Five, Six and Eight Lug Hubs
- Constructed from High-Quality, Impact-Resistant and Corrosion-Resistant Steel
- 2-5/8" Center to Center Hole Pattern
- 3/4" Steel Backing Plate and Reinforced Striking Plate for Long Life



Offer Good While Supplies Last Through March 31, 2025

### Master Wheel Hub and Bearing Remover/Installer Set

SKU 298230  
27213 **319<sup>99</sup>**

- For Removal and Installation of Front Wheel Hub and Bearings on Asian, Domestic and German Vehicles Along with Rear Wheel Hubs and Bearings on European Vehicles
- Works on Front, Rear and All-Wheel Drive Vehicles
- Self-Centering Design is Durable and Easy to Use



**BONUS**  
VALUE: \$74.99

**12 Pt. Axle Nut Socket Set - 8 Piece**  
24480



With Purchase of: 27213

Offer Good While Supplies Last Through March 31, 2025

### 23 Piece Hub Bearing Remover and Installer Set

SKU 094804  
27205 **229<sup>99</sup>**

- Removes and Installs Wheel Bearings with Steering Knuckle and Strut Assembly Still on the Vehicle
- Eliminates Need for Alignment



## Tie Rod Tools

### Master Inner Tie Rod Tool Set

SKU 344979  
27178 **89<sup>99</sup>**

#### Works on Both Small Cars and SUVs

- Tube Handle Has an Inner Diameter of 2.125" to Service Small Cars, Pickups and Large SUVs
- Includes 12 Crowfoot Style Adapters, Sizes: 29 mm, 1-3/16", 1-1/4", 32.5 mm, 1-5/16", 33.6 mm, 1-3/8", 1-7/16", 1-1/2", 38.4 mm, 40 mm and 42 mm



### Tie Rod End Remover

SKU 209525  
27175 **19<sup>99</sup>**

- Comes with Pressure Screw Tip Swivels for Damage Free Results
- Will Not Damage Tie Rod End Dust Boot
- Rust Resistant Finish



### Inner Tie Rod Tool Kit

SKU 217377  
27185 **44<sup>99</sup>**

- Removes and Installs Tie Rod End on Rack and Pinion Steering
- Includes: 3/16", 5/16" and 7/16" Adapters



### Inner Tie Rod Tool

SKU 291414  
LIS45750 **119<sup>99</sup>**

- 6 Sizes: 1-3/16", 1-1/4", 1-5/16", 1-7/16", 1-1/2" and 33.6 mm



## Pitman Arm Puller

### Pitman Arm Puller for Light Trucks

SKU OUTSIDE BUY/EPO  
27170 **64<sup>99</sup>**

- Services Cars and Light Trucks 3/4 Ton
- Features Forged Adjustable Jaws and Two Clamp Bolts That Lock Jaws Together
- Pressure Screw Has Ball Head Designed for Striking



For Outside Buy/EPO, Call 901-300-4878

## Pickle Forks

### Stepped Pickle Fork Set

SKU 291410  
LIS41400 **79<sup>99</sup>**

- 6 Tools in One
- Includes: 11/16", 15/16", 1-1/8"
- Forks and 2 Handles



### 5 Piece Tie Rod and Ball Joint Set

SKU 1103626  
37201 **49<sup>99</sup>**

- Used to Remove Tie Rods and Ball Joints
- Includes: 11" x 1-1/8", 11-3/4" x 1-5/8", 11-5/8" x 1-7/16", 16" x 11/16" and 16" x 15/16"





# CHASSIS & SUSPENSION

TO ORDER, contact your Commercial Sales Manager or go to [AutoZonePro.com](http://AutoZonePro.com)

CHASSIS & SUSPENSION

## CV Axle Nut Sockets

### 39 mm 12 Pt. Axle Nut Socket for Toyota

SKU 452638 LIS39650 **29<sup>99</sup>**

- Applications: 2008-2010 Toyota Land Cruiser, 2008-2010 Toyota Sequoia, 2007-2010 Toyota Tundra and 2008 Lexus LX 570



See AZTOOL1.com for Full Line of CV Axle Nut Sockets

## Axle Nut Socket Sets

OEM TOOLS®

- Includes Sizes: 29, 30, 32, 34, 35, 36, 38 and 39 mm

**69<sup>99</sup>**

### 6 Pt.

SKU 1103577 37320



### 12 Pt.

SKU 1103460 37321



## Bushing Tool Set

OEM TOOLS®

### Manual Bushing Installation and Removal Tool Set

SKU 298214 27212 **249<sup>99</sup>**

- Comprehensive Kit for Fast and Effective Removal/Installation of Wheel Bearings/Suspension Bushings and Seals
- Allows the Technician to Service a Wide Range of Bushings without Removing Components from the Vehicle
- Comes with 20 Sleeves for Hundreds of Combinations
- External Sleeve Diameter: 44, 46, 48, 50, 52, 54, 56, 58, 60, 62, 64, 66, 68, 70, 72, 74, 76, 78, 80 and 82 mm

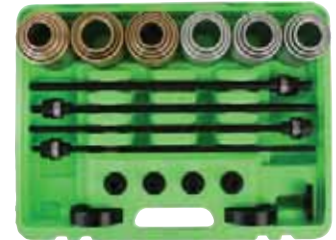

## Axle Tools

### CV Axle Puller Adapter

SKU OUTSIDE BUY/EPO 27058 **29<sup>99</sup>**

- Works with OEMTOOLS 37033, 37191, 27085, 27033 and Other Slide Hammer Pullers with 5/8" x 18 Threads



For Outside Buy/EPO, Call 901-300-4878

### CV Axle Popper Set

SKU 1189082 37305 **33<sup>99</sup>**

- Includes: Axle Shim Tool and Fork/Wedge Tool
- Length: 13-3/4"
- Used to Remove Axles from the Transmission, Ball Joints in the Suspension System and Tie Rods
- Fork Design Allows Mechanic to Exert Force Evenly on Both Sides of the Axle



### 5 Lb. Slide Hammer

SKU 1103572 37033 **54<sup>99</sup>**

- Use to Pull Bushings, Seals, Sleeves, Bearings, Flange-Type Rear Axles, Front-Wheel Drive Hubs, Dents and Pressed-In Bolts with Two or Three Jaw Puller Options
- Slide Rod is 3/4" x 16 Standard Threads



### 4WD Spindle Puller

SKU 143436 27104 **34<sup>99</sup>**

- Use with OEMTOOLS Slide Hammer 27033
- Fits Most Spindles 1-1/2", 1-5/8" and 2" on 4 Wheel Drive Vehicles
- Heat-Treated for Strength
- Will Fit on 2 Puller Size Shafts 1/2" x 20 Threads and 5/8" x 18 Threads



### Rear Axle Puller Set

SKU 094801 27202 **69<sup>99</sup>**

- Use for Flange-Type Rear Axle and Bearing Removal on Most Late Model Passenger Cars and Light Trucks
- Slide Rod and Adapters are 5/8" x 18 Standard Threads



### Axle Spindle Threading Set

SKU 1103645 37233 **49<sup>99</sup>**

- Use to Clean or Repair Axle Threads
- Set Comes with a Special Twist Shape That Provides Easier and Quicker Work
- Sizes Included: M20 x 1.25, M20 x 1.50, M22 x 1.00, M22 x 1.50, M24 x 1.50, M24 x 2.00, 13/16" x 20 UNEF, 3/4" x 20 UNEF and 27 mm Extension Bar



## Seal Tools

### Transmission/Transaxle Plugs

SKU 298196 24490 **12<sup>99</sup>**

- Includes 5 Plugs to Seal Both Transmissions and Transaxes on Most Import and Domestic Vehicles
- Stepped Design for Retention and Positive Sealing
- Includes Side Gear Centering Pin for Ford Transaxes



### Bearing Race and Seal Master Driver Set

SKU 1103639 37119 **32<sup>99</sup>**

- Installs Most Standard Wheel Bearings and Races
- Includes Driver Sizes: 1.565", 1.750", 1.965", 2.325", 2.470", 2.555", 2.830", 2.995", 3.180" and Handle



### Universal Seal Installer Set

SKU 818737 25082 **34<sup>99</sup>** REG. \$44.99

- Knurled Long Handle
- Includes: 3" Driver, 2.5" Driver, Short Handle, Long Handle, Spider Insert, 5/16" x 1" Cap Screw, Large Spider, Small Spider and Washer
- Long Handle Provides Good Flexibility When Installing Pinion Seals

**SAVE \$10**



Offer Good While Supplies Last Through March 31, 2025

Prices subject to change without notice. Prices do not include applicable taxes, vehicles, tires, rims, installation or optional equipment as shown. Please do not return purchases to the store. For information regarding warranty, repair, or any questions or concerns, call 901-300-4878.

AZG0125

# CHASSIS & SUSPENSION

## Power Steering Bleeders

### Vacuum Pump Tester, Power Steering and Brake Bleeder Set

SKU 1103570 **39<sup>99</sup>**  
37070

- Includes: Vacuum Pump Reservoir Jar with Transfer Lid, Storage Lid, Brake Bleeding Adapter Package, Steering Pump Adapters and Tubing



### Power Steering Bleeder Set

SKU 434716 **21<sup>99</sup>**  
27311

#### Reduce Comebacks

- Eliminate Trapped Air in Power Steering and Brake Systems Following Repairs or Fluid Changes
- Includes: 2 EPDM Tapered Rubber Adapters to Fit Most Power Steering Pumps and Reservoirs, Reservoir Bottle to Protect Hand Vacuum Pumps and 3 Sizes of Brake Bleeder Adapters
- Works with a Hand Vacuum Pump



## Drive Line Tools

### 1/2" Drive (12 mm) Ford Drive Line Impact Socket

SKU 420319 **19<sup>99</sup>**  
24212

- Applications Include Many Ford Drive Line Bolts
- 12 mm, 12 Pt.



## Power Steering Pullers

### Power Steering Pulley Remover/Installer - Ford, GM, Chrysler

SKU 1103578 **34<sup>99</sup>**  
37031

- Includes 2 Screws for Use on Most Ford, Chrysler, GM and VW Power Steering Pulleys
- Pulls Pulleys on GM Belt Driven Vacuum Pumps and Pressed-On Water Pump Pulleys of GM V6 Engines



### Steering Wheel Puller

SKU 1103540 **39<sup>99</sup>**  
37182

- Designed for All Major Makes and Models
- Sizes Included: 1/4" x 28, 8 mm x 1.25, 5/16" x 18, 5/16" x 24, and 3/8" x 16

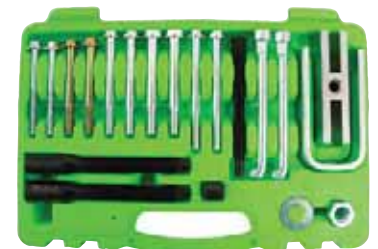

## U-Joint Tools

### U-Joint Pullers

- Easily Removes Seized U-Joint Cups on Most Passenger Vehicles and Light Duty Trucks
- Does Not Damage the Driveshaft, Yokes, Joints or Bearing Cups

### Automotive

SKU 949561 **59<sup>99</sup>**  
24539

- Bearing Cup Outside Diameter: 1" to 1.25"

### Intermediate

SKU 949565 **99<sup>99</sup>**  
24548

- Bearing Cup Outside Diameter: 1.25" to 1.7"

### Heavy Duty

SKU 041474 **124<sup>99</sup>**  
24538

- Bearing Cup Outside Diameter: 1.5" to 2.2"



### Automotive Bearing Cup Installer

SKU 949571 **54<sup>99</sup>**  
24549

- For the Installation of Bearing Cups on Light-Duty and Medium-Duty U-Joints
- Efficiently Install 2 Bearing Cups in One Process
- Contact Points Feature Magnets to Retain Bearing Cups During Operation



## Spindle Nuts

### GM Axle Hub Nut Socket

SKU 298219 **24<sup>99</sup>**  
25967

- Applications: GMT900 Silverado, Sierra HDCS, 2-Wheel (2WD) and 4-Wheel (4WD) Drive Cheyenne, Silverado, Escalade, Sierra and Avalanche Trucks with 10.5" or 11.5" Ring Gear
- Has 9 Pins to Fit GM New Style Retaining Nuts
- Unapproved Methods Can Damage the Bearing or Result in Shorter Service Life



### Dodge Hub Locknut Socket

SKU 344964 **29<sup>99</sup>**  
25968

- Fits Dodge 1/2-Ton Pickup Trucks (1994-Newer) with Dana 44 Front Axle and Dana 60 Axle with a Vacuum Disconnect
- Designed to Accommodate the 1-11/16" (43 mm) Wheel Bearing Retaining Nut Which is Recessed into the Hub



### Toyota 4 Pin Hub Locknut Socket

SKU 298224 **17<sup>99</sup>**  
25969

- Serves High Torque Locknuts on Toyota 4WD Vehicles Having Free Wheel (Lock Out) Hubs
- Tacoma (1995-Newer); T100 and 4Runner (1996-Newer)
- Improved Design with Solid Pins for Increased Durability



### Ford Rear Axle Nut Wrench

SKU 1392337 **29<sup>99</sup>**  
27353

- Serves 2003-Newer Ford F-250, F-350 and F-450 Super Duty Trucks with 10-1/2" Rear Axle
- Same as Ford Part Number 205-448
- Use with a 1/2" Drive Ratchet or Breaker Bar



### 1/2" Drive Socket Bearing Locknut

SKU 231203 **17<sup>99</sup>**  
25243

- Fits Adjusting Nuts Found on Ford F150 Trucks (1995 to 1996) and Full Sized Broncos with Automatic Locking Hubs



### 4WD Ford Spindle Socket, 66.5 mm x 80 mm

SKU 603346 **19<sup>99</sup>**  
25965

- Fits Ford F-Series 1/2-Ton Truck and Full-Size Bronco with Manual Hubs; 1995-Newer Ford F-Series 3/4-Ton and 1-Ton Trucks with Manual Hubs; 1959-85 Ford F-Series 1/2- and 3/4-Ton Trucks and Full-Size Bronco; 1960-90 GM 1/2-Ton Truck and Full-Size Blazer/Jimmy; 1969-89 Dodge 1/2-Ton Truck with Manual Hubs; 1969-72 International 1/2-Ton Truck
- 1/2" Sq. Drive



### 4WD Ford - Dodge Spindle Socket, 76 mm x 80 mm

SKU 603347 **21<sup>99</sup>**  
25966

### Toyota 8 Pin Front Hub Locknut Socket

SKU 298205 **34<sup>99</sup>**  
25962

- Allows for Easy Removal and Installation of Front Hub Lock Nut without Damage to the Nut
- Applications: Toyota 4Runner 2WD (2007 to 2014), Toyota Sequoia (2008 to 2014), Toyota Tundra (2007 to 2014)
- 3/4" Drive



# AIR CONDITIONING

TO ORDER, contact your Commercial Sales Manager or go to [AutoZonePro.com](http://AutoZonePro.com)

AIR CONDITIONING

FOR MORE DETAILS ON RECOVERY MACHINES GO TO [AZTOOL1.COM](http://AZTOOL1.COM)

## Recovery Machines

### ARCTIC COMMANDER 2.0

Dust Cover Included with All Machines



Warranty: 1 Year Parts and Labor

 <b>Mastercool</b> "World Class Quality"	Semi-Automatic R134a Recovery Machine SKU 1368632 MSC1100	Automatic R134a Recovery Machine SKU 1368636 MSC2100	Automatic R134a Hybrid Recovery Machine SKU 1368634 MSC3100	Automatic R1234yf Hybrid Recovery Machine SKU 1368616 MSC4100
Wi-Fi Capability	✓	✓	✓	✓
Refrigerant Database	Optional	✓	✓	✓
Built-In Tank Heater	✓	✓	✓	✓
Vacuum Pump	3 CFM	6 CFM	6 CFM	6 CFM
Dust Cover	✓	✓	✓	✓
Hose Flushing			✓	✓
Built-In Refrigerant Identifier				✓
Automatic Oil Injection		✓		
E-Printing Capability	Optional	Optional	✓	✓
<b>Price</b>	<b>3,799<sup>99</sup></b>	<b>4,749<sup>99</sup></b>	<b>5,049<sup>99</sup></b>	<b>6,549<sup>99</sup></b>

### ArcticPRO®



Warranty: 2 Years Parts and 1 Year Labor

<b>MAHLE</b>	Refrigerant 134a			Refrigerant 1234yf	
	ACX-2150 R134a Recovery Machine SKU 213170 MSSACX2150	ACX-2180 R134a Recovery Machine SKU 213168 MSSACX2180	ACX-2180H R134a Hybrid Recovery Machine SKU 213203 MSSACX2180H	ACX-2250 R1234yf Recovery Machine SKU 213151 MSSACX2250	ACX-2280 R1234yf Recovery Machine SKU 1187032 MSSACX2280
Automatic Oil Drain	✓	✓	✓	✓	✓
Automatic Air Purge	✓	✓	✓	✓	✓
Included Database	Optional	✓	✓	Optional	✓
Automatic Oil and Dye Injection	✓	✓			
Includes Refrigerant Identifier				✓**	✓*
Phone Application	Optional	✓	✓	Optional	✓
<b>Price</b>	<b>4,399<sup>99</sup></b>	<b>5,099<sup>99</sup></b>	<b>5,099<sup>99</sup></b>	<b>6,349<sup>99</sup></b>	<b>7,249<sup>99</sup></b>

On-Board Integrated Thermal Printer (Optional) \*Integrated \*\*Non-Integrated

### MSX



Warranty: 2 Years Parts and Labor

<b>cps</b>	R134a SKU 1407803 CPSMSX134	R1234yf SKU 1407806 CPSMSX1234	R134a/R1234yf SKU 1407510 CPSMSX3030	Heavy Duty R134a SKU 1407805 CPSMXHD
Fully Automatic	✓	✓	✓	✓
Onboard Oil Injection	✓			
High Capacity Oil-less Compressor	✓	✓	✓	✓
Vehicle Database Included	✓	✓	✓	✓
10 Ft. Service Hoses	✓	✓	✓	18' Hose
Includes 2 Tanks and 2 Sets of Hoses			✓	
Wi-Fi and Bluetooth Enabled	✓	✓	✓	✓
Touch Screen	7" Hi-Res	7" Hi-Res	7" Hi-Res	7" Hi-Res
Includes Refrigerant Identifier		✓	✓	
Converts Between R134a and R1234yf in 10 Min.			✓	
<b>Price</b>	<b>4,899<sup>99</sup></b>	<b>6,349<sup>99</sup></b>	<b>8,799<sup>99</sup></b>	<b>6,949<sup>99</sup></b>

Prices subject to change without notice. Prices do not include applicable taxes, vehicles, tires, rims, installation or optional equipment as shown. Please do not return purchases to the store. For information regarding warranty, repair, or any questions or concerns, call 901-300-4878.

AZG0125

# AIR CONDITIONING

## Recovery Machines

**KONFORT**



Warranty:  
2 Years Parts and Labor

TEXA	750R R134a Recovery Machine SKU 1282745 TEXZ11450	760 R1234yf Recovery Machine SKU 1282756 TEXA17910	780 Dual Gas Recovery Machine SKU 1282809 TEXA17810
Automatic Oil Drain	✓	✓	✓
Automatic Oil and Dye Injection	✓		
10 in. Multi-Touch Display		✓	✓
R134a Management	✓		✓
R1234yf Management		✓	✓
Vehicle Capacity Database	✓	✓	✓
Software Update Over Wi-Fi		✓	✓
Push-Pull Recovery	✓	✓	✓
Fully Automatic Operation	✓	✓	✓
<b>Price</b>	<b>5,399<sup>99</sup></b>	<b>8,749<sup>99</sup></b>	<b>10,549<sup>99</sup></b>

**ECOTECHNICS**



Training Videos



Warranty:  
1 Year Parts and Labor

Description	Hybrid Ready R134a SKU 1339733 HOFEAC820B	Hybrid Ready R1234yf SKU 1335790 HOFEAC830B	Eco Dual Gas A/C Service Station SKU 1335792 HOFEAC800
Refrigerant Type	R134a	HFO-1234yf	R134a + HFO1234yf
Refrigerant Tank	30 Lb.	30 Lb.	30 Lb. + 30 Lb.
Command Valves	Automatic	Automatic	Automatic
Display	5" Touch	5" Touch	7" Touch
Database	✓	✓	✓
Printer	✓	✓	✓
Status Light	✓	✓	✓
Hybrid Function	✓	✓	✓
<b>Price</b>	<b>4,799<sup>99</sup></b>	<b>6,399<sup>99</sup></b>	<b>10,499<sup>99</sup></b>

**ROBINAIR**



Warranty:  
1 Year Parts and Labor

Description	AC1234-4 Premier R1234yf SKU 1212384 ROBAC1234-4	AC1234-9 Connected R1234yf ACS SKU 1212383 ROBAC1234-9	34288NI Economy R134a SKU 221185 ROB34288NI	34788NI-H Premier R134a Refrigerant for Hybrid and Non-Hybrid Vehicles SKU 751572 ROB34788NI-H	34788NI Premier R134a Refrigerant SKU 751569 ROB34788NI	34998 Connected R134a ACS SKU 1212385 ROB34998
Operation	Automatic	Automatic	Semi-Automatic	<ul style="list-style-type: none"> <li>Automatic</li> <li>Hybrid Vehicle Applications</li> </ul>	<ul style="list-style-type: none"> <li>Automatic</li> <li>Auto Oil Injection</li> </ul>	<ul style="list-style-type: none"> <li>Automatic</li> <li>Auto Oil Injection</li> </ul>
Display	4.3" LCD Display	10" Hi-Res Touch Screen	4.3" Full Color Display	4.3" Full Color Display	4.3" Full Color Display	10" Hi-Res Touch Screen
Printer	ROB30038 (optional)	Wireless Printing	ROB30038 (optional)	ROB30038 (optional)	ROB30038 (optional)	Wireless Printing
Bluetooth and Wi-Fi		✓				✓
<b>Price</b>	<b>6,595<sup>99</sup></b>	<b>7,499<sup>99</sup></b>	<b>4,149<sup>99</sup></b>	<b>4,999<sup>99</sup></b>	<b>4,999<sup>99</sup></b>	<b>5,999<sup>99</sup></b>

## A/C VACUUM PUMP KITS - BETTER VALUE FOR YOUR MONEY

### A/C Service Set with Air Vacuum Pump - R134a

SKU 850564  
68991

- Includes: Air Vacuum Pump with 1/2" ACME R134a and R12 Connectors, Brass Manifold Gauge Set with 60" Hoses and Snap Style Couplers, Brass Can Tap Valve, Large Diameter Dual Scale Thermometer



**99<sup>99</sup>**

REG. \$138.96

**SAVE OVER \$38**

When You Buy the Kit

### Starter A/C Vacuum Pump Kit - R134a

SKU 1400034  
68950

- Includes: 1.8 CFM, 100 Micron Single Stage Vacuum, Professional Quality Extruded Aluminum Manifold with 72" Hoses, High Quality Manual Couplers and R134a Can Tap



**199<sup>99</sup>**

REG. \$241.97

**SAVE OVER \$41**

When You Buy the Kit

### R134a and R1234yf Spark-Free A/C Vacuum Pump Kit

SKU 1400036  
68951

- Includes: 6 CFM, 75 Micron, Spark-Free Single Stage Vacuum for Use with R134a or R1234yf, Extruded Aluminum Manifold Gauges, 72" Hoses with High Quality Manual Couplers, R1234yf Conversion Couplers That Convert R134a Manifold and Hoses to R1234yf, 1/2" ACME Right Hand to 1/2" ACME Left Hand Tank Adapter, 1/4" SAE x 1/2" ACME Hose to Vacuum Pump Adapter and R134a and R1234yf Can Tap



**349<sup>99</sup>**

REG. \$404.98

**SAVE OVER \$54**

When You Buy the Kit

### Recovery Machine Filters/Maintenance Kits

**ROBINAIR.**

**cps**

**Mastercool**  
"World Class Quality"

**MAHLE**

**ECOTECHNICS**

SKU	Part Number	Brand	Fits	Price
522875	ROB34430	Robinair	17700A, 34450, 34700, 34134Z	<b>133.99</b>
414883	ROB34724	Robinair	34288, 34788, 34788NI, 34788NI-H, 34988, 347002, 341342	<b>89.99</b>
752703	ROB13172	Robinair	Maintenance Kit for Models Using 34724 Filter - Includes Oil	<b>159.99</b>
186483	CPSARXF5	CPS	FX and AR Series CPS Equipment	<b>89.99</b>
1149172	CPSFX3030X1	CPS	Includes FX Series Filter, Vacuum Pump Oil and Coupler O-Rings for FX134A	<b>139.99</b>
389222	MSC69788FLTPK	Mastercool	69788, 69789 and 69789-H	<b>209.99</b>
199681	MSCCOM1FLTRPK	Mastercool	Commander 4000 and 4000x	<b>159.99</b>
199675	MSCCOM2FLTRPK	Mastercool	Commander 1000, 2000 and 3000	<b>199.99</b>
1149182	MSS3608325400	Mahle	ACX2180, ACX2180H and ACX2280	<b>119.99</b>
207349	MSS268077600	Mahle	ACX1120H, ACX1150, ACX1150H and ACX2120H	<b>119.99</b>
207508	MSS3608273900	Mahle	ACX1280, ACX2150 and ACX2250	<b>114.99</b>
818739	RTI3608213300	Mahle	RHS980 and ACX1180	<b>119.99</b>
1406968	HOFEAC33023B	EcoTechnics	HOFEAC800, HOFEAC810, HOFEAC820B, HOFEAC830B	<b>99.99</b>

### Portable Recovery Systems

#### R-134 Twin Turbo Complete Recovery Machine

SKU OUTSIDE BUY/EPO  
MSC69360

**1,949<sup>99</sup>**

- Largest Volume Recovery Rate on the Market
- For Use with All Refrigerants Including R410A
- Injection Molded High Density Polyethylene Case for Maximum Durability
- Safety High Pressure Switch
- Revolutionary Double Piston Oil-Less Compressor



#### R1234yf Twin Turbo Complete Recovery Machine

SKU OUTSIDE BUY/EPO  
MSC69360-YF

**1,849<sup>99</sup>**

- Revolutionary Double Piston Oil-Less Compressor
- Largest Volume Recovery Rate on the Market
- Includes: 30 Lb. DOT Tank, Sight Glass, R1234yf Low Side Coupler, Oil Drain Bottle and R1234yf Blue and Yellow Hoses



#### R134a/R1234yf Complete A/C Recovery Set

SKU OUTSIDE BUY/EPO  
MSC69372

**1,999<sup>99</sup>**

- Built with the Safest Spark-Free Components
- Includes All Hoses and Couplers Needed to Recover, Cleanse and Remove the Oil from R134a and R1234yf Automotive A/C Systems
- 30 Lb. DOT Tank for R134a and 30 Lb. DOT Tank for R1234yf Refrigerants Included with Each Unit (Refrigerant Sold Separately)
- 115V/60 Hz
- 1/2 HP Oil-Less Compressor
- Compatible Refrigerants: All CFCs, HCFCs and HFCs



To Confirm Price, Availability and Ordering Instructions on Outside Buy/EPO, Call 901-300-4878

# AIR CONDITIONING

## Vacuum Pumps

### 1.8 CFM Single Stage Vacuum Pump

SKU 466312 **129<sup>99</sup>**  
24500

- Motor: 1/4 HP, 110V
- Ultimate Vacuum Rating: 100 Microns
- Inlet Ports: 1/2" ACME - 1/4" Flare
- Oil Capacity: 6.7 Oz. (200 mL), Included
- Internal High Volume Cooling Fan for Extended Use



### 4 CFM Single Stage Vacuum Pump

SKU 466305 **139<sup>99</sup>**  
24501

- Motor: 1/3 HP, 110V
- 75 Microns
- Inlet Ports: 1/2" ACME 1/4" Flare
- Oil Capacity: 11 Oz. (330 mL), Included
- Internal High Volume Cooling Fan for Extended Use



### 6 CFM Single Stage Vacuum Pump

SKU 466306 **184<sup>99</sup>**  
24502

- Motor: 1/2 HP, 110V
- 75 Microns
- Inlet Ports: 1/2" ACME - 1/4" Flare
- Oil Capacity: 11 Oz. (330 mL), Included
- Internal High Volume Cooling Fan for Extended Use



### 6 CFM Spark-Free Vacuum Pump

SKU 213133 **259<sup>99</sup>**  
24642

- Motor: Spark-Free 1/2 HP, 110V
- Ultimate Vacuum Rating: 75 Microns
- 3 Inlet Ports: 1/4" Flare, 1/2" ACME and 1/2" ACME LH
- Oil Capacity: 330 mL, Included
- Internal High Volume Cooling Fan for Extended Use
- Can Be Used with R1234yf Refrigerant



### Black Series 1.8 CFM Single Stage Vacuum Pump

SKU 1414397 **169<sup>99</sup>**  
MSC90059-BL

- 80 Microns
- 1/4 HP
- 110/120 V, 60 Hz
- T-Fitting 1/4" FL-M x 1/2 ACME-M



### 1.8 CFM Deep Vacuum Pump

SKU 1330695 **179<sup>99</sup>**  
MSC290059RCL

- 1.8 CFM Deep Vacuum Pump
- 1/4" and 1/2" Fittings
- For Use with Multiple Refrigerants



### 3 CFM Single Stage Vacuum Pump

SKU 1392324 **199<sup>99</sup>**  
MSC290062

- Large Fan Keeps Vacuum Pump Cooler and Extends Life
- 1/4" SAE and 1/2" ACME Port Access
- 110-120V, 60 Hz Voltage



### 6 CFM 2 Stage Vacuum Pump

SKU OUTSIDE BUY/EPO **399<sup>99</sup>**  
MSC900662V-BL

- 15 Microns
- 1/2 HP
- 110/220 V, 50/60 Hz
- Includes: 3 Inlet Ports: 1/4", 3/8" SAE and 1/2" ACME

For Outside Buy/EPO,  
Call 901-300-4878



### Spark-Free 6 CFM Vacuum Pump (Single Stage)

SKU 1400035 **354<sup>99</sup>**  
MSC90066BLSF

- 80 Microns
- 1/3 HP
- 110/120V, 60HZ
- T-Fitting 1/4" FL-M x 1/2 ACME-M



### Air-Operated Vacuum Pump

SKU 544730 **39<sup>99</sup>**  
24533

- Includes: 1/2" ACME (R134a) and R12 Connectors
- Air Pressure Range: 75 to 180 psi
- Air Consumption: 4.2 CFM @ 90 psi
- Vacuum Capacity: 28.3" of Mercury @ 90 psi



### Vacuum Pump Oil (8 Oz.)

SKU 363429 **10<sup>00</sup>**  
24399

- Increases Life Span of the Pump
- Performance of Your Pump Depends on Regular Service and the Quality and Purity of the Vacuum Pump Oil That You Use
- Compatible for Use in Pumps Made by Most Manufacturers



### Premium Vacuum Pump Oil 1 Quart Bottle

SKU 517580 **19<sup>99</sup>**  
CPSVPOQ12

- Compatible with Most Pumps
- Increases Life Span of the Pump
- Performance of Your Pump Depends on Regular Service and the Quality and Purity of the Vacuum Pump Oil That You Use



**STORE STOCKED**

Prices subject to change without notice. Prices do not include applicable taxes, vehicles, tires, rims, installation or optional equipment as shown. Please do not return purchases to the store. For information regarding warranty, repair, or any questions or concerns, call 901-300-4878.

## Manifold Gauges

### R1234yf Manifold Gauge and Hose Set

SKU 752518 **149<sup>99</sup>**  
24559

- 3" Easy-to-Read Gauges with Temperature Chart
- 72" Hoses
- High Quality 6-Ball Manual Couplers

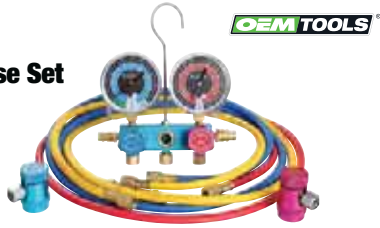

OEM TOOLS®

### Dual Aluminum R134a/R1234yf Gauge Set

SKU 1335797 **144<sup>99</sup>**  
25130

- Includes: 72" Hoses, Manual Couplers and Can Tap Valves with 1/2" ACME Fittings for Use with Both R134a and R1234yf Refrigerants

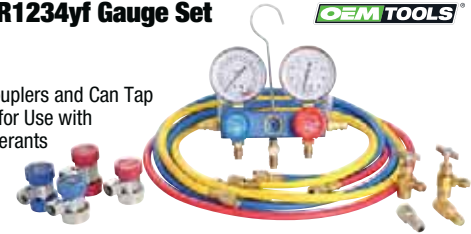

OEM TOOLS®

### R134a Brass Manifold Gauge Set

SKU 752520 **74<sup>99</sup>**  
24563

- High Quality Brass Body with Sight Glass
- Large 2-1/2" Gauges are Easy to Calibrate and Have a High Impact Lexan Lens
- 60" Hoses (3,000 psi Burst, 600 psi Working Pressure)
- Snap Style Quick Couplers

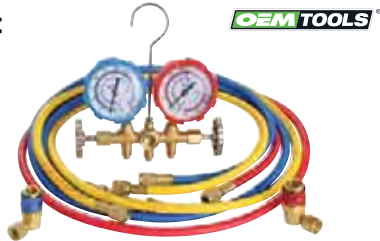

OEM TOOLS®

### R134a A/C Manifold Gauge and Hose Set

SKU 466319 **99<sup>99</sup>**  
24527

- Easy-to-Read 2-3/4" Spring Dampened Gauges to Reduce Flutter
- Extruded Aluminum Manifold
- 72" Hoses with Manual Couplers



OEM TOOLS®

### Deluxe R134a Gauge Set

SKU 1282751 **119<sup>99</sup>**  
MSC289772CL

- Solid Block Extruded Aluminum Manifold
- 72" Long Hoses with Manual Couplers
- Gauge Guards for Protection

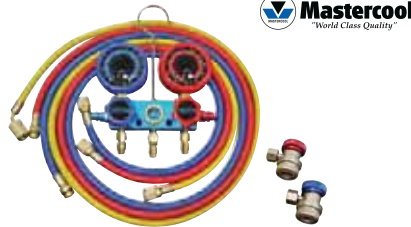

Mastercool®  
"World Class Quality"

### Dual R134a, R-12 Manifold Gauge Set

SKU 1335804 **139<sup>99</sup>**  
MSC293996PBCL

- Solid Block Extruded Aluminum Manifold
- 96" Long Hoses with Manual Couplers
- Gauge Guards for Protection
- Silicone Dampened Calibratable Gauges
- Extra Long Hose for Access to Heavy Duty Buses, Fleet and Refrigerated Trucks Systems



Mastercool®  
"World Class Quality"

### R134a Aluminum Manifold Kit with Dye Injector

SKU 290023 **154<sup>99</sup>**  
MSC89660UV

- Includes: R134a Aluminum Manifold, 60" Hoses, Standard Couplers and 10 Application Mini Dye Injector



Mastercool®  
"World Class Quality"

### Dual R134a/R1234yf Brass Gauge Set

SKU 1142631 **164<sup>99</sup>**  
MSC66661AYF

- 2-1/2" Silicone Dampened, Recalibrateable Gauges
- Extra Access Port for Vacuum Line
- R1234yf High and Low Side Quick Couplers R134a High and Low Side Economy Couplers 1/2" ACME-M x 1/2" ACME-F LH Thread Adapter (2) 12 mm-M x 14 mm-F R1234yf Adapters Set of 3 - R134a Standard Hoses

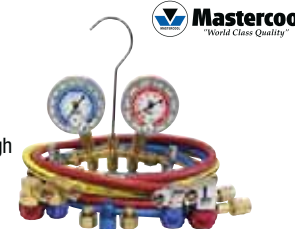

Mastercool®  
"World Class Quality"

### R1234yf Aluminum Manifold Gauge Set

SKU 505065 **249<sup>99</sup>**  
MSC83272

- Ideal for Shops That Want to Wait to Invest in New AC Service Stations Adapted for R1234yf
- Contains Manifold, 3 Service Hoses, 2 Service Couplers LT/HT

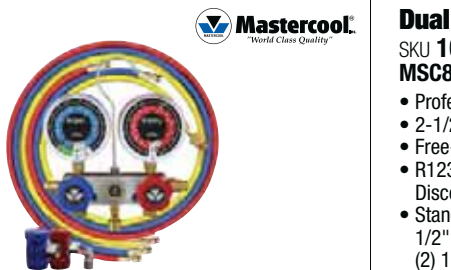

Mastercool®  
"World Class Quality"

### Dual Aluminum R134a/R1234yf Gauge Set

SKU 1086254 **289<sup>99</sup>**  
MSC89661AYF

- Professional Extruded Aluminum Block
- 2-1/2" Silicone Dampened, Re-Calibrateable Gauges
- Free-Floating Piston Type Valves Reduce O-Ring Wear
- R1234yf High and Low Side Couplers with Extended Disconnect Protection Sleeve
- Standard Hoses, R134a Manual Couplers, R1234yf Couplers, 1/2" ACME-M x 1/2" ACME-F LH Thread Adapter, (2) 12 mm-M x 14 mm-F R1234yf Adapters



Mastercool®  
"World Class Quality"

## Can Taps

### R1234yf Self-Sealing Can Tap

SKU 213178 **11<sup>99</sup>**  
24553

### R134a Can Tap Valve

SKU 466315 **11<sup>99</sup>**  
24524



OEM TOOLS®

### 4-Way Side Can Tap

SKU 1103203 **34<sup>99</sup>**  
FJC6842

- For Use with R-12, R134a or R1234yf Refrigerant Cans and Oil Change Cans
- Fits Cans with 2-7/8", 2-1/2" and 2" Diameter
- Includes: 1/2" ACME LH, 1/2" ACME and 1/4" Flare Male Fitting with Check Valve



FJC

### Refrigerant and Oil Charge Side Can Tap

SKU 466313 **15<sup>99</sup>**  
24523

- Fits 1 Lb. Cans of R134a, R12 and 2" Oil Charge Cans
- Plier Type Grip with Positive Lock
- Includes: 1/2" ACME Male and 1/4" FL Male Ports with Safety Valve



OEM TOOLS®

### 3-In-1 Side Mount Can Tap Valve

SKU 290033 **19<sup>99</sup>**  
MSC85530

- Unique Design will Work on All R134a (2-7/8"), R12 (2-1/2") and Oil Charge (2") Cans
- Outlet Port Offers a 1/2" ACME and 1/2" FL Fitting with an Internal Check Valve to Prevent System Backflow



Mastercool®  
"World Class Quality"

# AIR CONDITIONING

## Electronic Leak Detection

### A/C Refrigerant Leak Detector

SKU 466307 **79<sup>99</sup>**  
24510

**Detects All Types of Halogenated Refrigerants**

- Sensitive to 0.1 Oz. per Year Single Color LED Display with 7 Level Leak Alarm
- Flexible Stainless Steel Probe to Reach Almost Any Space
- Includes Spare Sensor Tip
- Works with 1234yf



### Black Series Infrared Refrigerant Leak Detector

SKU OUTSIDE BUY/EPO **499<sup>99</sup>**  
MSC55600-A

- Easily Select Sensitivity Levels with a Maximum Sensitivity Up to 0.14 Oz./Yr.
- TFT Screen Provides Clear and Easy Readings That Show Leakage, Sensitivity, Battery Level and Sensor Fault Indicators
- Designed to Meet EN14624, SAE1627, SAE2791 and SAE2913 Standards

For Outside Buy/EPO, Call 901-300-4878



### Raptor Refrigerant Leak Detector

SKU 916550 **239<sup>99</sup>**  
MSC56100

- Features 3 Sensitivity Levels and 5 Detection Levels
- Detects Leaks as Small as 1/10 Oz. per Year
- Detects All Refrigerants (CFC, HCFC, HFC)
- Flexible 16" Probe for Hard-to-Reach Areas
- Works with 1234yf



### Inspector 2-in-1 Electronic/UV Leak Detector

SKU 916553 **289<sup>99</sup>**  
MSC56200

- Pinpoint Leaks as Small as 1/10 Oz. (3 gr) Per Year
- Built-In Ultra-Bright UV Light at End of Probe – Allowing Easy Access into Tight Areas
- Works with 1234yf



## Manifold Gauge Repair

### R1234yf 72" Hose Set

SKU 1142322 **89<sup>99</sup>**  
MSC83372

- Working Pressure: 800 psi
- Burst Pressure: 4,000 psi
- For Use with R1234yf
- Meets J2888, EPA, SAE and UL Standards
- Includes: 1 ea. Blue/Red 72" 12 mm-M x 12 mm-M and Yellow 72" 12 mm Fitting x 1/2 x 16 ACME LH

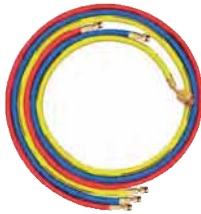

### 96" R134a Red Hose

SKU 489152 **39<sup>99</sup>**  
MSC84963

- 1/2" ACME-F and 14 mm-M Auto A/C Fittings - 96"



### 96" R134a Blue Hose

SKU 489151 **39<sup>99</sup>**  
MSC84961

- 1/2" ACME-F and 14 mm-M Auto A/C Fittings - 96"



### Replacement Gauge High Side for A/C Manifold

SKU 481705 **19<sup>99</sup>**  
24530

- Replacement High Side Gauge Fits OEMTOOLS® and Other Brands of A/C Manifolds Used to Service A/C Systems on Cars
- 1/8" NPTF Male Threads
- Reads 0 to 500 psi



### Replacement Gauge Low Side for A/C Manifold

SKU 481709 **19<sup>99</sup>**  
24531

- Reads 0 to 120 psi and 0 to 30" Hg

### R134a Hose Set 72"

SKU 752516 **45<sup>99</sup>**  
24558

- 72" R134a 3 Hose
- Set Color Coded: Red, Yellow and Blue



### 1/4" Hose Set 72"

SKU 752515 **29<sup>99</sup>**  
24557

- 72", 1/4" SAE 3 Hose
- Color Coded: Red, Yellow and Blue



### A/C Manifold Upgrade Kit

SKU 1043688 **68903**

- Includes: 3-in-1 Side Mount Can Tap Valve, R134a Manual Coupler Set, 1234yf Self Sealing Can Tap, 1/2" ACME Hose Set 72", R134a to HFO-1234YF Conversion Coupler Set



**129<sup>99</sup>**  
REG. \$148.95

**SAVE OVER \$18**  
When You Buy the Kit

### R1234yf Manifold/Hose Adapter Assortment

SKU 1142732 **19<sup>99</sup>**  
25091

- 6 Common Adapters to Fit Manifolds, Hoses, Couplers and Vacuum Pumps
- Includes: 1/2" LH ACME Female x 1/4" Male Flare, 1/2" ACME Male x M12 x 1.5 Male, 1/2" ACME Female x M12 x 1.5 Female, 1/4" Male Flare x M12 x 1.5 Male, 1/2" LH ACME Female x M14 QDK, 1/2" LH ACME Male x 1/4" Female Flare
- Includes Organizer Case with I.D. Labels



### R134a/RI2 Charging Hose Repair Kit

SKU 295557 **39<sup>99</sup>**  
MSC91334-A

- 50 Piece Assortment of Replacement Gaskets, O-Rings, Depressors for Charging Hoses and Adapters





## A/C Couplers



### R134a Manual Coupler Set

SKU 362980 **24<sup>99</sup>**  
24396

- All Metal Construction for Extra Durability
- 6-Ball Coupler for Secure Grip
- Includes: Adapter for Use with R12 Hoses



### R134a High Side Manual Coupler

SKU 347267 **17<sup>99</sup>**  
24395

### R134a Low Side Manual Coupler

SKU 347266 **17<sup>99</sup>**  
24394

## Conversion Coupler Set R134a to R1234yf

SKU 752527 **49<sup>99</sup>**  
24561

- 1234yf Manual Couplers with 14 mm Female Threads to Convert R134a Manifold and Hoses to R1234yf
- Includes: Tank Adapter, 1/2" ACME Right Hand to 1/2" ACME Left Hand Adapter



## Manual R134a Safety Lock Coupler

- Suitable for Use On All R134a Systems
- Safety Lock Ensures That Hose Remains Connected During Operation
- Meets All SAE, UL and EPA Requirements for Containment of Refrigerant

## High-Side, 1/4" FL-M x 16 mm

SKU 695636 **39<sup>99</sup>**  
MSC82834-SLE

## Low-Side, 3/8" FL-M x 13 mm

SKU 695637 **39<sup>99</sup>**  
MSC82934-SLE



## R134a Premium Manual Coupler Set

- SKU **OUTSIDE BUY/EPO**  
CPSQC134SET **69<sup>99</sup>**
- Latching Balls to Provide Superior Service
  - Cross Pin Valve Depressor and Safety Sleeve to Prevent Accidental Refrigerant Venting



For Outside Buy/EPO, Call 901-300-4878

## R134a Extra Long Coupler

SKU 752517 **19<sup>99</sup>**  
24556

- Used on BMW E60 (2003-2009 5 Series) and Some Volvo Models
- Allows for A/C Service with No Radiator Removal



## R134a Refrigerant Tank Adapter

SKU 850565 **14<sup>99</sup>**  
24554

- Male Low-Side R134a to Female 1/2" ACME
- Attaches to Virgin Tank and Low-Side Service Coupler



## R1234yf Low Side Tank Adapter Assembly

SKU 1103204 **14<sup>99</sup>**  
25086

- Used to Fill Refrigerant from R1234yf Cylinders
- Attaches to Virgin Tank and Low Side Service Coupler
- This Fitting Does Not Have a Valve Core or Valve Core Depressor



## R1234yf Hose to Vacuum Pump Adapter Fitting 1/4" x 1/2"

SKU 600806 **12<sup>99</sup>**  
24509

- 1/4" SAE x 1/2" ACME Female LH Thread



## Valve Core Tools

### No Gas Loss A/C Valve Core Remover/Installer

SKU 466321 **37<sup>99</sup>**  
24529

- Remove and Install Standard R134a Valve Cores without the Loss of Refrigerant
- Built-In Ball Valve Retains Charge and Allows Access to A/C System
- For 13 mm and 16 mm High and Low Service Ports
- Includes Blow Mold Case



### Universal Valve Core Remover/Installer for R134a/R12

SKU 1142576 **209<sup>99</sup>**  
MSC58490

- Kit Covers All R12 and R134a System Valve Cores for Standard, JRA, Eaton and GM Large Bore
- Includes: Valve Assembly, R134a High Side 16 mm Connector, R134a Low Side 13 mm Connector, 1/4" FL Swivel Connector, Adapter 1/4"-M x 3/16"-F High Side GM/Ford, Adapter 1/4"-M x 1/8"-F High Side Ford and Blow Mold Case



### A/C Valve Core Tool

SKU 466314 **12<sup>99</sup>**  
24555

- Double Ended Valve Core Tool to Service Both Standard and Large Bore R134a and R12 Cores



### Universal Valve Core Remover/Installer for R1234yf

SKU 1043686 **134<sup>99</sup>**  
MSC58490-YF

- Attaches to R1234yf Service Ports to Quickly and Easily Remove and Replace Valve Cores without the Loss of Refrigerant
- Ball Valve Design with Stainless Steel Ball Provides Smooth Movement and Durability
- Kit Covers 17 mm and 14 mm High and Low Side Service Ports
- Includes: Valve Assembly, High Side 17 mm Connector, Low Side 14 mm Connector, Standard Valve Core Shaft, GM Large Bore Valve Core Shaft and Eaton R134a/R1234yf High Side Valve Core Shaft



## A/C Service Tools

### A/C Condenser Fin Comb Straightener/Cleaner

SKU 466317 **9<sup>99</sup>**  
24526

- Clean and Straighten Condenser and Evaporator Coils
- Compact Design for Confined Spaces
- Includes: 6 Clearly Marked Combs: 8, 9, 10, 12, 14 and 15 Fins per Inch



### Valve Core Tool Set (2 Piece)

SKU 1209377 **12<sup>99</sup>**  
22589

- Designed for Removal and Installation of Schrader Style Valve Cores



### A/C Clutch Holding Tool

SKU 1392339 **19<sup>99</sup>**  
26550

- Holds Compressor Clutch in Place When Removing the Holding Bolt
- Adjustable Pins to Fit Various Compressor Clutches
- Compatible with Domestic and Import Vehicles



### A/C Clutch Hub Puller and Installer

SKU 1103539 **79<sup>99</sup>**  
37150

- Features All the Tools Necessary to Remove and Install Pressed on A/C Clutch Hubs on Many Domestic and Import Vehicles
- Includes: Orifice Tube Extractor Tool Set

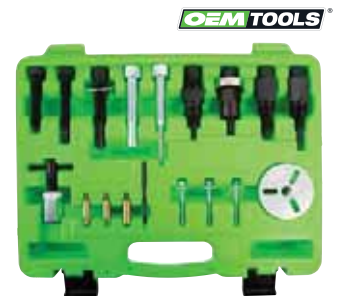

## BONUS VALUE: \$29.99

### 26 Piece Master Orifice Tube Assortment

24564  
With Purchase of: 37150  
Offer Good While Supplies Last  
Through March 31, 2025



# AIR CONDITIONING

## SpotGun® Jr.

### SpotGun® Jr. Univ. Oil/UV Dye Kit for R134a/R1234yf - 1 Oz.

SKU 1368623 **199<sup>99</sup>**  
UVU390100

- Works with Both R134a and R1234Yf Refrigerant Systems
- 4 Universal Oil Cartridges (1 Oz.)
- 2 ExtenDye™ Cartridges (1 Oz.)
- 2 LeakGuard™ OneShot Cartridges (1 Oz.)
- 2 Low-Side Service Adapter Hoses and R134a/R1234yf Couplers



### A/C ExtenDye™ Cartridge

- SAE J2297 Certified Super Concentrated UV Dye
- Works in R134a, R1234yf Systems and is Hybrid Safe
- Contains Friction Modifier to Increase Lubricity and Decrease Friction
- Contains Antioxidant to Prolong Oil Life
- Anti-Wear Additive for Better Wear Resistance
- Works with SpotGun® Jr. Injection System

### A/C ExtenDye™ Cartridge 1 Oz. (4 Pack)

SKU 1362004  
UVU399020A

**54<sup>99</sup>**



### A/C ExtenDye™ Cartridge .25 Oz. (6 Pack)

SKU OUTSIDE BUY/EPO  
UVU399006APK6

**54<sup>99</sup>**



### Universal PAG 46 Oil R1234yf - 1 Oz. Cartridge (4 Pack)

SKU 1407808 **49<sup>99</sup>**  
UVU399046YFPK

- OEM Approved
- Works with SpotGun® Jr. Injection System
- Formulated to Work with R1234yf, R134a and Hybrid Safe
- Sealed Cartridge Assures Clean Oil Delivered to Vehicle A/C System
- Injection System Measures the Correct Dosage



### Universal PAG 46 Oil for R134a 1 Oz. Cartridge (12 Pack)

SKU OUTSIDE BUY/EPO **84<sup>99</sup>**  
UVU399046PK12

### SpotGun® Jr. Univ. Oil/UV Dye Kit for R134a/R1234yf - 1 Oz. with UV Lite

SKU 1400039 **254<sup>99</sup>**  
UVU390200

- Works with Both R134a and R1234Yf Refrigerant Systems
- Includes UV Phazer (AAA) UV Lite and UV Enhancing Glasses
- 4 Universal A/C Oil (1 Oz.)
- 2 ExtenDye™ Cartridges (1 Oz.)
- 2 LeakGuard™ OneShot Cartridges (1 Oz.)



To Confirm Price, Availability and Ordering Instructions on Outside Buy/EPO, Call 901-300-4878

## SpotGun®

### SpotGun® Univ. Oil/Dye Kit for R134a/R1234yf - 8 Oz. without UV Lite

SKU OUTSIDE BUY/EPO **169<sup>99</sup>**  
UVU490100

- Works with Both R134a and R1234Yf Refrigerant Systems
- 1 Universal Oil Cartridge (8 Oz.)
- 1 ExtenDye™ Cartridge (8 Oz.)
- Service Maintenance Stickers
- 2 Low-Side Service Adapter Hoses and R134a/R1234yf Couplers



### SpotGun® Univ. Oil/Dye Kit for R134a/R1234yf - 8 Oz. with UV Lite

SKU OUTSIDE BUY/EPO **224<sup>99</sup>**  
UVU490200

- Works with Both R134a and R1234Yf Refrigerant Systems
- 1 Universal Oil Cartridge (8 Oz.)
- 1 ExtenDye™ Cartridge (8 Oz.)
- UV Phazer™ Black (AAA Batteries Included) UV Enhancing Glasses



### A/C ExtenDye™ Cartridge - 8 Oz.

SKU OUTSIDE BUY/EPO  
UVU499108A

**69<sup>99</sup>**

- Works in R134a, R1234yf Systems and is Hybrid Safe
- Contains Friction Modifier
- Contains Antioxidant to Prolong Oil Life
- Fits Competitive Guns



## Mastercool

### Professional UV Leak Detection Kit with 12V/50W UV Light

SKU 290041 **99<sup>99</sup>**  
MSC53351

- 12 Volt/50 Watt UV Leak Detector
- 1 Oz. Coolant Dye, 1 Oz. Oil/ATF/Fuel Dye, Dye Remover
- Mini Dye Injector (10 Applications of Universal A/C Dye) Compatible with R134a and R12 Adapter
- UV Enhancing Safety Glasses
- 12 Service Labels



### Universal Concentrated Dye Cartridge 1 Oz. (5 Pack)

SKU 505040 **99<sup>99</sup>**  
MSC53810-5

- 5 Pack of Dye for 53585 Leak Detector Kit
- 10 Applications per Bottle



## Diagnostic Work Light

The Most Innovative 3-in-1

13.4" Multi-Use Rechargeable Diagnostic Under-the-Hood Work Light

SKU 591153  
24609 **79<sup>99</sup>**

- 5 Hr. Run Time on High



UV Leak Dye Detection Light



400 Lumens Super Bright Work Light



Yellow Smoke Detection Light



OEM TOOLS®

Charge Devices with Universal USB Port



Digital Charge Level Indicator



## Leak Detection Lights

UV Phazer Professional 395nm Leak Detection Light

- Adjustable Zoom Lens Allows for Focusing Light Intensity In a Smaller/Larger Area for Precision Viewing
- Rechargeable Li-ion Battery

Black

SKU 1405963  
UVUEW40395 **99<sup>99</sup>**

- High Output True UV LED Light
- Precise, True UV Wavelength and Bandwidth to Optimize the Fluorescence of UV Dyes
- Max. Run Time: 4 Hrs.



NEO

SKU 1400042  
UVUEW50395 **139<sup>99</sup>**

- UV Dye Shines Brighter with the Phazer Neo Than Any Other UV Light
- Water Resistant
- Max. Run Time: 5 Hrs.



UVIEW®

UV Leak Detection Light and Glasses

SKU 213144  
24516 **19<sup>99</sup>**

- Compact UV Leak Detection Pen Light
- Can Be Used with All Types of UV Leak Detection Dyes
- Yellow Lens Protective Glasses Enhance Visibility of Leaks
- Includes: 2 AA Batteries



OEM TOOLS®

Magnifying Glass with 5 LED and 1 UV Light

SKU 191688  
25465 **14<sup>99</sup>**

- Compact Magnifier with 5 LED Lights and a Super Bright UV Light
- UV Light Detects Dyes



OEM TOOLS®

## Refillable Injectors

OEM TOOLS®

In-Line Dye and Oil Injector

SKU 466322  
24532 **39<sup>99</sup>**

- Add Up to 2 Oz. of Oil or Dye to a System Under Vacuum or While Adding Refrigerant
- 1/2" ACME Fittings to Fit Most R134a Systems
- Use with UVU499008A A/C ExtenDye™ Bottle (8 Oz.)



R12 and R134a Hand Turn Dye Injector

SKU 466320  
24528 **69<sup>99</sup>**

- Injects Dye or Oil into R12 or R134a Systems
- Refillable, Capacity: 2 Oz.
- Includes: R134a Quick Coupler
- Use with UVU499008A A/C ExtenDye™ Bottle (8 Oz.)

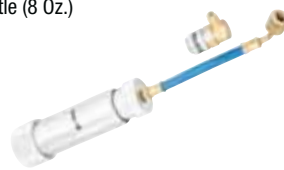

OEM TOOLS®

## Pourable Dyes

A/C ExtenDye™ Bottle - 8 Oz.

SKU OUTSIDE BUY/EPO  
UVU499008A **54<sup>99</sup>**

- SAE J2297 Certified Super Concentrated UV Dye
- Works in R134a, R1234yf Systems and is Hybrid Safe
- Contains Friction Modifier to Increase Lubricity and Decrease Friction
- Contains Antioxidant to Prolong Oil Life
- Anti-Wear Additive for Better Wear Resistance



UVIEW®

For Outside Buy/EPO, Call 901-300-4878

Multi-Purpose Dye

SKU 1392316  
UVUB483206 **44<sup>99</sup>**

- Pinpoint Leaks in Engine Oil, Transmission, Hydraulic, Power Steering, Gasoline and Diesel Fuel Systems



R1234yf Hand Turn Oil and Dye Injector

SKU 213158  
24517 **84<sup>99</sup>**

- Easy to Operate Hand Turn Injection
- Durable Aluminum Construction with Laser Etched Filling Guide
- Includes R1234yf System Coupler
- 2 Oz. (60 mL) Capacity
- Use with UVU499008A A/C ExtenDye™ Bottle (8 Oz.)

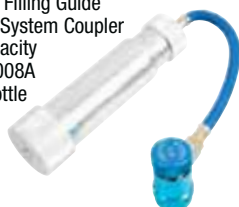

OEM TOOLS®

Refillable Universal Dye Injector for R1234yf

SKU 764999  
MSC53123-YF **149<sup>99</sup>**

- Heavy Duty Aluminum Construction
- Injects Dye or Oil into R1234yf Systems
- Refillable, Any Dye or Oil Can Be Used
- Easy Twist Injection System
- Precise Injection Control



Mastercool®  
"World Class Quality"

PAG 46 Oil with A/C ExtenDye™ 8 Oz. Bottle (4 Pack)

SKU 1400040  
UVU488046PBD4 **54<sup>99</sup>**

PAG 100 Oil with A/C ExtenDye™ 8 Oz. Bottle (4 Pack)

SKU OUTSIDE BUY/EPO  
UVU488100PBD4 **79<sup>99</sup>**

For Outside Buy/EPO, Call 901-300-4878



# AIR CONDITIONING

## Orifice Tube

OEM TOOLS®

### 26 Piece Master Orifice Tube Assortment

SKU 851868 **29<sup>99</sup>**  
24564

- Covers Most Vehicles That Require Air Conditioning Orifice Tubes
- Includes: Chrysler (Orange, Purple T-Top), Ford (Black, Blue, Brown, Green, Red), GM (Black T-Top, White, Yellow), Jeep (Green - White) and Volvo (Yellow)



## A/C O-Ring Assortment

HARDWARE  
MACHINERY

### 270 Piece A/C O-Ring Kit

SKU 271196 **17<sup>99</sup>**  
68141

- Great O-Ring Set for Most Automotive and Refrigerant Applications

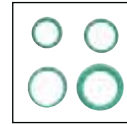

Kit Contains 270  
O-Rings in a Variety  
of SAE Sizes



## Digital Scales

OEM TOOLS®

### Digital Refrigerant Scale (240 Lb. Capacity)

SKU 752521 **149<sup>99</sup>**  
24560

- High-Visibility .75" x 2.5" LCD Backlit Display
- 3 Units of Measure: Kg/Oz./Lb.
- Automatic Shut-Off After 10 Minutes, Backlight Will Shut Off After 3 Minutes
- Fully Enclosed and Removable Metal Scale Platform Enables Use of Product in or Out of the Protective Case



### Black Series Electronic Charging Scale with Bluetooth

SKU 290029 **289<sup>99</sup>**  
MSC98210-BL

- Includes Bluetooth Wireless Technology
- Capacity: 243 Lb.
- Accuracy:  $\leq \pm 0.05\%$  of Reading
- Resolution: 0.05 Lb./0.5 Oz./0.01 kg
- Rugged, Non-Slip Platform



Mastercool®  
"World Class Quality"

## A/C Flush

### A/C Flush Machine

SKU OUTSIDE BUY/EPO  
CPSAFM100

**1,599<sup>99</sup>**

- Air Operated 8' Hoses to Reach Any System
- Forward or Reverse Flush without Changing Hoses
- 2-1/2 Gallon Capacity Tank for Use on Cars and Buses
- Universal Couplers Allows Connection to Most Types of Connections
- Clear Filter Bowl Allows You to See What is Coming Out of the System with a Cleanable Filter

For Outside Buy/EPO, Call 901-300-4878

### A/C Supreme Flush, 1 Gallon Can

SKU OUTSIDE BUY/EPO **84<sup>99</sup>**  
CPSAFMSF

- Superior Flush Removes Particles Including Common Leak Sealants, That Can Damage Refrigerant Recovery Machines and A/C System Components



CPS®

### MASTERCLEANSE A/C Flush Machine

SKU OUTSIDE BUY/EPO **929<sup>99</sup>**  
MSC69900

- Designed to Flush All HVAC/R and Automotive Systems
- Pump Power: 0.4 HP; Flow Rate: 4 Gal/Min.
- Stainless Steel Ball Valve Controls
- 1/4" SAE Connection
- Pump Equipped with Mechanical Seal and PTFE Gasket
- 110 VAC

For Outside Buy/EPO, Call 901-300-4878

### Adapter Kit

SKU 481575 **134<sup>99</sup>**  
MSC69925

- Isolates A/C System Components for Closed Loop Flushing
- Flush Individual Components without Removing Them from the Vehicle
- Install Adapters on A/C Line Ends to Allow Attachment of Flushing Equipment



Mastercool®  
"World Class Quality"



### A/C Flush Kit

SKU 1103579 **49<sup>99</sup>**  
37377

- Uses Shop Air to Pressurize the Solvent to Thoroughly Clean the System
- Simple, Effective and Easy to Use
- Attached Nozzle Directs the Solvent without Sprayback
- Includes: Canister, Hose, Blowgun, Rubber Tip and Cylinder Cap
- Solvent Purchased Separately



OEM TOOLS®

### A/C Flush Solvent

#### Bottle (32 Oz.)

SKU 695650 **24<sup>99</sup>**  
MSC91049-32

#### 1 Gallon

SKU 695653 **64<sup>99</sup>**  
MSC91049-128

MSC91049-32



Mastercool®  
"World Class Quality"

MSC91049-128

Prices subject to change without notice. Prices do not include applicable taxes, vehicles, tires, rims, installation or optional equipment as shown. Please do not return purchases to the store. For information regarding warranty, repair, or any questions or concerns, call 901-300-4878.

# AIR CONDITIONING

TO ORDER, contact your Commercial Sales Manager or go to [AutoZonePro.com](http://AutoZonePro.com)

AIR CONDITIONING

## A/C Hose and Line Repair

OEM TOOLS®

### Heavy Duty Ratcheting Hose Cutter

SKU 466311 24522 **19<sup>99</sup>**

- Smooth Action and High Quality Blade Provide Quick, Clean and Accurate Cuts
- Ratcheting Action Makes it Faster and Easier to Use than Other Cutters
- Cuts Rubber Hose and PVC Up to 1-1/2" OD
- Wide Hooked Jaws Hold Tubing Securely



### Ratcheting Tubing Cutter

SKU 466309 24520 **29<sup>99</sup>**

- Ratcheting Action is Ideal Where Space is Limited
- Cuts 1/4" to 7/8" Tubing
- Spare Cutting Wheel Included



## Thermometers

OEM TOOLS®

### Thermal Imaging Camera

SKU 213193 24552 **199<sup>99</sup>**

- Temperature Range: -4°F to 1,202°F (-20°C to 650°C), Selectable Temperature (C or F)
- Captures Thermal Images and Saves to MicroSD Card (Not Included)
- 3 Selectable Color Palettes
- 1.8" LCD Color Display
- Includes Storage Pouch and Mini USB Cable



### Hand-Held Hydraulic Crimper Kit for A/C Hoses

SKU OUTSIDE BUY/EPO FJC2806 **349<sup>99</sup>**

- Includes Complete Set of Dies
- For Hose Sizes: #6, #8, #10, #12 and Reduced Barrier Hose Sizes
- Hand-Held, Hydraulic Tool – Ideal for Shop and Field Applications
- Custom-Molded Protective Case



For Outside Buy/EPO, Call 901-300-4878

### Manual Style A/C Hose Crimper, Bench or Vise Mounted

SKU 290028 MSC71550 **319<sup>99</sup>**

- Manual Style A/C Hose Crimper
- Mount to Bench Using Holding Fixture or Place in Vise
- Includes: 71500 - 001 Yoke Assembly, 71550 - 002 Arbor Assembly, 71550 - 003 Holding Fixture Assembly, 71500 - 6 Die Set - #6 (5/16"), 71500 - 8 Die Set - #8 (13/32"), 71500 - 10 Die Set - #10 (1/2"), 71500 - 12 Die Set - #12 (5/8") and 71500-PB Custom Mold Box Carrying Case



### Infrared Thermometer with Target Laser

SKU 290019 MSC52224ASP **79<sup>99</sup>**

- Temperature Range: -58°F to 1022°F (-50°C to 550°C)
- Includes: Laser Thermometer and Analog Dial Thermometer in Storage Case
- 4 Digit LCD Backlit Display with Auto Power-Off (After 15 Seconds)



## AirSept® Line Repair

**SAVE TIME & MONEY!**

**FIX or TERMINATE a Line in 5 MINUTES!**



**CERTIFIED LEAK-FREE**



UP TO 2,600 psi

OE-APPROVED REPAIR SOLUTION INSTALLS IN MINUTES, NO SPECIAL TOOLS, NO GLUE

### Line Terminator SAE (5 Pack)

SKU 504122 AIR76526 **109<sup>99</sup>**

- Quickly and Effectively Blocks A/C Lines at the Damage Point or at the Front System "Y"
- Block Off Leaking Rear Evaporators and Failed System Components
- Include One Each: 5/16", 3/8", 1/2", 5/8" and 3/4" SAE Kits



### Line Terminator SAE/Metric (10 Pack)

SKU 504124 AIR76530 **199<sup>99</sup>**

- Quickly and Effectively Blocks A/C Lines at the Damage Point or at the Front System "Y"
- Block Off Leaking Rear Evaporators and Failed System Components
- Includes One Each: 5/16", 3/8", 1/2", 5/8", 3/4", 8 mm, 10 mm, 12 mm, 15 mm and 16 mm



### Line Splice Straight SAE/Metric (10 Pack)

SKU 504103 AIR76051 **284<sup>99</sup>**

- Includes One Each: 5/16", 3/8", 1/2", 5/8", 3/4", 8 mm, 10 mm, 12 mm, 15 mm and 16 mm



### Line Terminator Rear A/C Blockoff Kits

- Quickly and Effectively Blocks A/C Lines at the Damage Point or at the Front System "Y"
- Block-Off Leaking Rear Evaporators and Failed System Components
- Help Maximize Front A/C Performance
- Eliminate Refrigerant and Oil Pooling in Rear A/C Lines



### Line Splice Straight Repair Kit

- High-Tech Anti-Vibration Tension Ring Ensures Durability in Tough Automotive Applications
- HNBR Seal Sleeve Dramatically Expands the Sealing Surface Area
- Burst Tested to 2,600 psi



### Smart Splice™ Line to Hose

- Leak-Proof Line Splice™ Technology on the Metal Side of the Connection
- Superior Hose Crimp Technology on the Rubber Side
- Also Works for Heater and Coolant Lines
- Install in 5 Minutes



SKU	Part #	Size	Price
504149	AIR76502	3/8" Line	<b>26.99</b>
504146	AIR76501	1/2" Line	<b>26.99</b>
504150	AIR76503	5/16" Line	<b>26.99</b>
504152	AIR76504	5/8" Line	<b>30.99</b>
504154	AIR76505	3/4" Line	<b>35.99</b>
329221	AIR77508	8 mm OD Line	<b>26.99</b>
329219	AIR77510	10 mm OD Line	<b>26.99</b>
329231	AIR77515	15 mm OD Line	<b>30.99</b>
329230	AIR77516	16 mm OD Line	<b>30.99</b>

SKU	Part #	Size	Price
504140	AIR76003	5/16" Line	<b>35.99</b>
504138	AIR76002	3/8" Line	<b>35.99</b>
504136	AIR76001	1/2" Line	<b>35.99</b>
504143	AIR76011	5/8" Line	<b>44.99</b>
504132	AIR77008	8 mm Line	<b>35.99</b>
504155	AIR77010	10 mm Line	<b>35.99</b>

SKU	Part #	Size	Price
504125	AIR76701	1/2" Line to #8 Hose	<b>35.99</b>
504128	AIR76702	3/8" Line to #6 Hose	<b>35.99</b>
OSB/EPO	AIR76704	5/8" Line to #10 Hose	<b>44.99</b>

For Outside Buy/EPO, Call 901-300-4878

Prices subject to change without notice. Prices do not include applicable taxes, vehicles, tires, rims, installation or optional equipment as shown. Please do not return purchases to the store. For information regarding warranty, repair, or any questions or concerns, call 901-300-4878.

AZG0125

# BATTERY SERVICE

## Battery Testers

**OEM TOOLS**

### Professional Series Battery Tester

SKU 750009 **19<sup>99</sup>**  
24508

- Large Tester Uses Gravity with the Number of Floating Discs to Show State of Battery Charge
- Specific Gravity Levels are Printed on the Tough, See-Through Plastic Body
- Large 16-1/4" Disc-Type Tester is Accurate Down to -40°F



### Digital Battery Analyzer

SKU 819073 **39<sup>99</sup>**  
24359

- Shows Available Power in CCA Starter and Charging System Testing
- Easy-to-Read Backlit LCD Screen
- Voltage Range: 1.5-15VDC
- Battery CCA: 200-1200



**STORE STOCKED**

### 100 Amp Battery Load Tester

SKU 203583 **32<sup>99</sup>**  
24338

- Conveniently Tests Batteries in Just 10 Seconds
- Battery Load Test: 100A (12V), 50A (6V)
- Designed to Work on Both 6V and 12V Batteries Up to 1,000 CCA
- Determines State of Charge, Cranking and Charging Volts
- Convenient Handle for Transport



### 500 Amp Carbon Pile Load Tester

SKU 1168827 **79<sup>99</sup>**  
24336

- Variable Load Capability to 500 Amps
- Tests Batteries to 1,000 CCA
- Test Alternators, Regulators and Starters
- Large, Easy-to-Read Gauges
- Heavy Duty Clamps



### Battery Conductance Tester

**MIDTRONICS** Advancing Battery Management

SKU 291330 **239<sup>99</sup>**  
MIDPBT100

- Tests Both the Starter and the Charging System
- Tests 12V Automotive Batteries from 200 to 850 CCAs
- Durable Design for the Workshop or in the Field



### BT MobilePro S Jump Start/Power Bank/BSC System Analyzer

SKU 1485041 **129<sup>99</sup>**  
TPDBTMPROS

- Turns Your Diagnostic Scan Tool into a Battery Tester
- Compatible to Phoenix Line of Diagnostic Scanners
- Battery, Cranking and Charging Tests
- Tablet Compatibility
- Test Voltage: 12V
- Test Range: 100~2000CCA
- Battery Type: Regular Flooded, AGM, EFB and GEL
- Test Standards: CCA, BCI, CA, MCA, JIS, DIN and More



### BT600 Battery Tester with Printer

SKU 1339732 **149<sup>99</sup>**  
TPDBT600

- 3.5" Color Screen
- Built-In Thermal Printer
- Performs Complete Battery, Cranking and Charging Tests
- Large, Reinforced, Smoke-Free and Spark-Free Copper Clamps
- Quick and Accurate Test Results



### Thermal Printer Paper for BT600, BT300P

SKU 1442591 **34<sup>99</sup>**  
TPDBTPAPER

### 12V Digital Battery Electrical System Tester with Printer

SKU 343373 **459<sup>99</sup>**  
ASC12-1015

- Tests Both Batteries Up to 1,700 CCA and Alternators
- Tests Starters and Charging Systems
- Backlit Digital Display
- 9 Languages
- Includes: Deluxe Case and Extra Print Paper



### 12/24V Digital Battery Electrical System Tester with Printer

SKU OUTSIDE BUY/EPO **499<sup>99</sup>**  
ASC12-2415

- Tests Both Batteries Up to 2,000 CCA and Alternators

For Outside Buy/EPO, Call 901-300-4878

## Battery Service Tools

### Side Terminal Battery Wrench

- For Use with Side Terminal Batteries Found on Many GM and Other Domestic Vehicles



5/16" SKU 466513 **9<sup>99</sup>**  
25287

- Length: 5-1/2"

10 mm and 5/16" SKU 965838 **14<sup>99</sup>**  
25282

- Length: 12"

### 2 Liter Battery Filler

SKU 972771 **19<sup>99</sup>**  
87010

- Automatic Shut-Off to Prevent Overfilling
- Fills Battery to Proper Level without Spilling



### Battery Terminal Puller

SKU 466489 **10<sup>99</sup>**  
25121

- Use to Remove Battery Terminal Clamp without Damaging the Battery Post
- Puller Will Also Work on Corroded Spring-Type Clamps

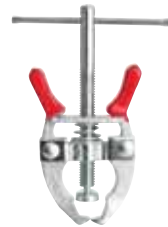

### Battery Nut Pliers

SKU 943134 **19<sup>99</sup>**  
25123

- Easily Tighten and Loosen Nuts
- Offset Handles
- Serrated Jaws for a Firm Grip



### Battery Carrier

SKU 002284 **18<sup>99</sup>**  
25316

- Designed to Grab, Lift and Carry Top Post and Side Terminal Batteries
- Grips Battery Widths from 5" to 7" with Rubber Pads
- Plastic Hand Grip Provides a Firm Hold



### 6 Piece Battery Service Kit

SKU 1168822 **69<sup>99</sup>**  
25110

- Includes: Battery Terminal Puller, 4-Way Post Cleaner, Battery Nut Pliers, Extended 5/16" and 10 mm Battery Terminal Wrench, 5/16" Side Terminal Battery Wrench and a Side Terminal Brush Organized in a Heavy Duty, Roll-Up Storage Sleeve



# BATTERY SERVICE

TO ORDER, contact your Commercial Sales Manager or go to [AutoZonePro.com](http://AutoZonePro.com)

BATTERY SERVICE

## Jump Starters

TOPDON®

### Battery Tester and Jump Start

SKU 1368635  
TPDV2200PLUS **119<sup>99</sup>**

- Jump Start Capacity: 8L Gas, 6L Diesel
- 2200A Peak Current for Jumps
- Use the App to Perform Detailed Battery Tests
- 300 Lumen LED Light with Solid, SOS and Strobe Functions
- Output Ports: Type-C: USB1, USB2, DC



### JumpSurge 3000 Amp Portable Jump Starter

TOPDON®

SKU OUTSIDE BUY/EPO  
TPDJS3000 **169<sup>99</sup>**

Sturdy Outer Housing Resistant to Water, Dust and Wear

- 45 Jumps on a Single Charge
- USB Quick Charge 3.0 Port
- Heavy Duty Smart Clamps



### Kwikstart® 12 Volt Portable Power and Jump Start

ASSOCIATED

SKU 850637  
ASC6256 **264<sup>99</sup>**

- Peak Amp Output: 1700 Amps
- 360 CCA of Boost Assist
- (2) 12V DC Accessory Outlets to Power and/or Recharge DC Electronics
- 32" Heavy Duty Cables and USB Port



### 30,000 mAh Lithium Jump Starter for V10 and Diesel

SKU 1268417  
CAL590 **249<sup>99</sup>**



New Improved Design

- Vehicle Jump Starter and Backup Charger for Portable Electronics
- 800 Cranking Amps and 1800 Peak Amps
- 30,000 mAh High Capacity Li-ion Battery
- Fast Charging with Low Self-Discharge Cycle
- Includes: Intelli-Clamps for Jumpstarting with Built-In Safety and Diagnostic Features



### Premium 1700 Peak Amp 12 Volt Jump Starter

SOLAR®

SKU OUTSIDE BUY/EPO  
SOLJNC770R **324<sup>99</sup>**

- Heavy Duty Clamps with 68" Cables
- 1700 Peak Amps; 425 Cranking Amps
- Dual USB Outlets to Charge Mobile Devices
- Master ON/OFF Switch



### 1700 Peak Amp 12 Volt Jump Starter

SKU OUTSIDE BUY/EPO  
SOLJNC660 **299<sup>99</sup>**

- Heavy Duty Clamps with 46" #2 AWG Welding Cables.
- 1700 Peak Amps; 425 Cranking Amps
- Heavy Duty Clamps with 46" Cables

### 3400 Amp 12/24 Volt Jump Starter

SOLAR®

SKU OUTSIDE BUY/EPO  
SOLJNC1224 **649<sup>99</sup>**

- Voltmeter Provides Charge Status of Onboard Battery
- Clore PROFORMER Battery Technology
- 3400 Peak Amps and 850 Cranking Amps - 12V
- 1700 Peak Amps and 425 Cranking Amps - 24V



### 2-in-1 2200 Peak Amp Jump Starter and Tire Inflator

SKU 1485043  
TPDV2200AIR **129<sup>99</sup>** **NEW**

TOPDON®

- Battery Capacity: 12000mAh
- Delivers a Powerful 2200A Peak Current with Up to 25 Starts Per Charge
- Capable of Jump-Starting Vehicles with Engines Up to 8.0 Liters for Gasoline or 6.0 Liters for Diesel
- Functions as a PD45W Fast-Charging Power Bank
- 400-Lumen LED Flashlight
- Tire Inflator Fills in Under 3 Minutes



### 2-in-1 4500 Peak Amp Jump Starter and Battery/System Tester

SKU 1485040  
TPDV4500PLUS **229<sup>99</sup>** **NEW**

TOPDON®

- Up to 45 Jump Starts on a Single Charge
- Test and Monitor Battery with App
- Peak Amps: 4500
- 500 Lumen Flashlight
- Outputs: Bidirectional TYPE-C, USB1, USB2
- IP65-Rated Casing
- Includes: D45W Charger Adapter, DC Adapter, DC Adapter and PD100W Cable



To Confirm Price, Availability and Ordering Instructions on Outside Buy/EPO Call 901-300-4878

## Wheeled Chargers

SOLAR®

### Battery Charger 12V

SKU OUTSIDE BUY/EPO  
SOL4735 **289<sup>99</sup>**

- EZ View Control Panel
- 200 Amp Engine Starting Assistance
- 40 Amp Fast Charge Rate
- 5 Amp Setting for ATVs, Boats, Lawn and Garden Applications



### Battery Charger with Engine Start 12/24V

SKU OUTSIDE BUY/EPO  
SOL4745 **354<sup>99</sup>**

- 40 Amp 12V, 20 Amp 24V Charge Rate

SOL4735

For Outside Buy/EPO, Call 901-300-4878

## Smart Charger

### 30A Smart Charger and Power Supply

SKU 1442582  
TPDT30000 **299<sup>99</sup>**

- Suitable for Multiple Battery Types, Including AGM, LI, WET, GEL, MF CAL and EFB
- 9-Step Smart Charging, Checks for Sulphation and Acid Stratification, Repairs Batteries, Prevents Battery Damage
- Works as a Stable Power Supply for 12V and 24V Devices
- Current Range: 12V-30A, 24V-15A, 6V-15A, 12V-10A
- Clamp Cable Length and Gauge: 7.2', AWG10



TOPDON®

One Charger Does It All

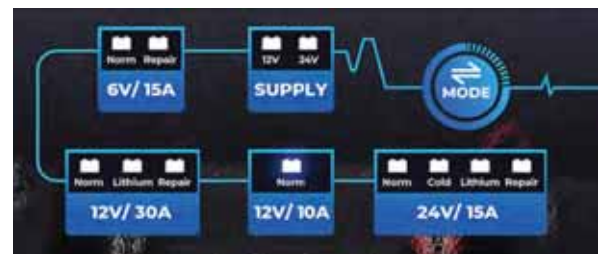

Prices subject to change without notice. Prices do not include applicable taxes, vehicles, tires, rims, installation or optional equipment as shown. Please do not return purchases to the store. For information regarding warranty, repair, or any questions or concerns, call 901-300-4878.

AZG0125

# BATTERY SERVICE

## Associated Battery Chargers

**ASSOCIATED**



Safe In Any Weather



Made in USA



	Commercial Duty Charger SKU 221248 ASC6002B	Heavy Duty Fleet Charger/Analyzer SKU 1414394 ASC6021AGM	Heavy Duty Charger SKU 662763 ASC6012AGM	Intellamatic® Charger and Re-flash Power Supply			
				SKU 344790 ASCESS6008	SKU 343379 ASCESS6008MSK	SKU 343370 ASCESS6007B	SKU 662745 ASCI6008MSK
Charger Type	Wheel	Wheel	Wheel	Wheel	Wheel	Wheel	Wheel
UL of CSA Continuous Amperage Charging Rate	100/80A	70/65/30A	70/60A	60A	60A	40A	60A
Re-Flash Power Supply Output Amperage	N/A	N/A	N/A	70A @ 13.9V	70A @ 13.9V	45A @ 13.9V	70A @ 13.9V
Crank Assist Amperage	400	205A	250	270	270	130	270
Operating Charging Voltage	6/12/18/24V	6/12/24V	6/12V	12V	12V	12V	12V
Battery Types	SLA	SLA, AGM, EFB	SLA, AGM, EFB	SLA, AGM, Gel-Cell, EFB	SLA, AGM, Gel-Cell, EFB	SLA, AGM, Gel-Cell, EFB	SLA, AGM, EFB, Li-ion, Gel-Cell
Smart Charger	N	N	N	Y	Y	Y	Y
Adjustable Charging Voltage	N	N	N	N	N	N	Y
Adjustable Re-Flash Power Supply Voltage	N	N	N	Y	Y	Y	Y
Memory Saver Mode	N	N	N	N	Y	N	Y
DC Cable Length and Gauge	8' 4AWG	6.5' 4AWG	6.5' 6AWG	6.5' 6AWG	6.5' 6AWG	6.5' 6AWG	6.5' 6AWG
Warranty*	2 Year B2B 5 Year Limited	2 Year B2B 5 Year Limited	2 Year B2B 5 Year Limited	2 Year B2B 3 Year Limited	2 Year B2B 3 Year Limited	2 Year B2B 3 Year Limited	2 Year B2B 3 Year Limited
<b>Price</b>	<b>1,224<sup>99</sup></b>	<b>874<sup>99</sup></b>	<b>679<sup>99</sup></b>	<b>979<sup>99</sup></b>	<b>1,114<sup>99</sup></b>	<b>784<sup>99</sup></b>	<b>1,379<sup>99</sup></b>

\*Two years bumper to bumper (B2B) manufacturer's warranty with five years transformer/rectifier for heavy duty battery chargers (6001A, 6002B, 6006, 6009 and 6012) and three years transformer/rectifier warranty for INTELLAMATIC wheeled smart chargers.

## Bench Chargers

### 6/12V, 1A Maintainer

SKU 765478  
ASC9003A **69<sup>99</sup>**

- LED Lights Indicating Charging Status
- Includes 2 Sets of Charging Leads
- OEM Vehicle Manufacture Approved
- Safe for AGM, Gel Cell, SLA Batteries
- Reverse Polarity Protected
- Overcharge Protection
- 1 Year Warranty



### 6/12V, 10/2A Smart Bench Top Charger

SKU 850633  
ASC3055A **159<sup>99</sup>**

- Digital Display Shows Charging Voltage/ Amperage or Time Remaining
- Safe for SLA, AGM, Gel Batteries
- 50A Boost
- 1 Year Warranty



### 6/12V, 15/2A Smart Bench Top Charger

SKU 850634  
ASC3100A **199<sup>99</sup>**

- Digital Display Shows Charging Voltage/ Amperage or Time Remaining
- Safe for AGM, Gel Cell, SLA Batteries
- 100A Boost
- 1 Year Warranty



**ASSOCIATED**



# BATTERY SERVICE

TO ORDER, contact your Commercial Sales Manager or go to [AutoZonePro.com](http://AutoZonePro.com)

BATTERY SERVICE

## Booster Cables

OEM TOOLS

### 20 Ft. 4 Gauge Booster Cables with Storage Bag

SKU 1168815 **29<sup>99</sup>** REG. \$39.99

SAVE \$10

- Extra Long 20 Foot Flexible Cables Expands Your Reach
- Tangle Free Design Ensures Quick and Easy Connections
- Insulated Clamps Fit Top and Side Post Batteries
- Oil, Gas and Acid Resistant All Copper Wire
- Includes: Storage Bag



Offer Good Through March 31, 2025

### 20 Ft. Heavy Duty Booster Cables

SKU 972269 **239<sup>99</sup>** ASC6160

ASSOCIATED

- 500A Vinyl Coated Steel Clamps with Copper Jaws and Strain Relief Guards
- T-94 Jacked Stays Flexible to -40°F
- 4AWG Tangle-Free Copper Cable
- Made in USA



### Clamp Kit 400 Amp

SKU 110434 **39<sup>99</sup>** ASC6199

ASSOCIATED

- Professional Quality Heavy Duty Clamps for All Booster Cables



## Power Supply

ASSOCIATED

### 12V - 90A Reflash Power Supply and Charger

SKU OUTSIDE BUY/EPO **1,614<sup>99</sup>** ASCESS6100

- Adjustable Power Supply from 12.6V to 14.9V at up to 90 Amps
- Safe for All Batteries Including AGM, EFB, Li-ion and Gel
- OEM Vehicle Manufacture Approved
- 8.4 Ft. DC Leads



For Outside Buy/EPO, Call 901-300-4878

### Smart Battery Charger/Power Supply

SKU 1414398 **699<sup>99</sup>** TPDT90000

- ECU Programming Power Supply
- 9 Step Smart Charging with Thermal Compensation
- Charges 12V and 24V AGM, WET, GEL, MF, CAL and EFB Batteries
- Protects Against Reverse Polarities, Reverse Charges, Short Circuits, Overheating and Over-Voltages
- Current Range: 5-90 and 5-45A
- Voltage Range: 11-15.8V and 22-31.5V
- Cables: AWG18-70"

TOPDON



**BONUS VALUE: \$99.99**

### Tornado90000 9.5' DC Cable Extension

TPDT90DC With Purchase of: TPDT90000

Offer Good While Supplies Last Through March 31, 2025



### 120A Power Supply and Battery Charger

SKU 1485033 **949<sup>99</sup>** TPDT1200005 **NEW**

TOPDON

- Intelligent Current (5-120A) and Voltage (11-16.8V) Output Adjustment
- 3 Major Charging Modes and 9-Step Smart Charging
- Compatible with Lead-Acid Batteries and Lithium Batteries
- Clamp Cable Length: 16 Ft.



## AUTEL MAXIBAS BATTERY & ELECTRICAL ANALYSIS

### MaxiBAS® BT609

SKU 1125832 Part #BT609

- Adaptive Conductance Technology: Produces a More Accurate Exam of the Battery's Status
- All System Scan, Read and Clear Codes
- Complete Service Menu 20+ Functions



### MaxiBAS® BT608

SKU 1105501 Part #BT608

- Adaptive Conductance Technology: Detects Battery Capacity Reducing Misdiagnosis
- Auto Battery Reset / Print Test Reports Via Built-in Thermal Printer
- AutoSCAN/VINScan for Quick Vehicle Identification & Battery Specifications



### MaxiBAS® BT506

SKU 1125835 Part #BT506

- Use with Smartphone or other Smart Device
- Support In-vehicle and Out-of-Vehicle Testing of Passenger Vehicle Batteries
- Test 6- and 12-volt Batteries: 100 - 2000 CCA
- Test 12- and 24- Cranking/Charging Systems
- Test Flooded, AGM, AGM Spiral, EFB & GEL Batteries



### OBDII EXTENSION CABLE

SKU 1443473 Part #VCIEXTCAB

- Compatible with all OBDII-compliant VCIs
- It keeps VCI in sight and is easy to retrieve and not forget after use



### MaxiBAS® BTAK

SKU 1149588 Part #BTAK

- Battery Tester Accessory Kit
- Digital Multimeter and Current Clamp Kit
- Measures Voltage, Current and Resistance



### MaxiBAS® BTMS

SKU 1149587 Part #BTMS

- Battery Tester Memory Saver
- Preserves Vehicle Codes and Electronic Presets When Replacing Battery
- Enables Vehicle Computer to Be Powered and Maintain Data When Connected to Backup Vehicle Battery



## AUTEL MAXIEV ADVANCED EV DIAGNOSTICS

NEW EV RELEASE



### MaxiEV® ALT100L

SKU 1442217 Part #ALT100L

- Tests high voltage battery enclosures and high voltage thermodynamics systems such as coolant and A/C for leaks
- High-sensitive pressure sensing significantly improves test accuracy and stability
- Dual Pressure Display: Real-time display of current pressure and leakage fluctuations



### MaxiEV® CDT100

SKU 1443474 Part #CDT100

- Wide-voltage design, suitable for discharge, charge, and activation testing of modules with different voltage levels
- Set constant current and power, Charge and Discharge modes for varied applications
- Displays single-cell maximum/minimum voltage and other data onscreen in graphs, columns, and report forms



### MaxiEV® ITS100

SKU 1442216 Part #ITS100

- Tests high voltage wiring and components
- Test resistance measurement before loading into the vehicle
- Helps identify issues like damage, deterioration, or contamination of the insulation

CALL FOR PRICE

AUTEL

Prices subject to change without notice. Prices do not include applicable taxes, vehicles, tires, rims, installation or optional equipment as shown. Please do not return purchases to the store. For information regarding warranty, repair, or any questions or concerns, call 901-300-4878.

AZG0125

65

# AIR COMPRESSORS



ABA3-2160V1



ABA5-2160V4



ABA5-2180V4NS



ABAC5-2180V  
ABAC5-2380V



ABAC7-2180V2  
ABAC7-2380V2



ABA13-30GH



ABAC10-23120H



An Atlas Copco Company

	<b>3.5 HP 60 Gallon 230V Air Compressor, Single Phase</b> SKU OSB/EPO ABA3-2160V1	<b>5 HP 60 Gallon 230V Air Compressor, Single Phase</b> SKU OSB/EPO ABA5-2160V4	<b>5 HP 80 Gallon 230V Air Compressor, Single Phase</b> SKU OSB/EPO ABA5-2180V4NS	<b>5 HP 80 Gallon 230V Air Compressor</b> SKU OSB/EPO ABAC5-2180V - Single Phase ABAC5-2380V - 3 Phase	<b>7.5 HP 80 Gallon 230V Air Compressor</b> SKU OSB/EPO ABAC7-2180V2 - Single Phase ABAC7-2380V2 - 3 Phase	<b>13 HP 30 Gallon Honda Powered Air Compressor</b> SKU OSB/EPO ABA13-30GH	<b>10 HP 120 Gallon 230V Air Compressor, 3 Phase</b> SKU OSB/EPO ABAC10-23120H
CARB Compliant	N/A	N/A	N/A	N/A	N/A	Yes	N/A
CFM at 100 psi	12.3 CFM (1 Technician)	15.4 CFM (1-2 Technicians)	15.4 CFM (1-3 Technicians)	18 CFM (2-3 Technicians)	27 CFM (2-4 Technicians)	23 CFM (1-3 Technicians)	35 CFM (3-6 Technicians)
Max. Pressure	135 psi	175 psi	175 psi	175 psi	175 psi	175 psi	175 psi
Heavy Duty, Low-RPM Cast Iron Pump	Cast Iron Cylinders	Cast Iron Cylinders	Cast Iron Cylinders	Yes	Yes	Cast Iron Cylinders	Yes
Magnetic Starter Mounted and Wired	Not Required	Not Required	Not Required	Yes	Yes	Recoil and Electric Start	Yes
High Flow Belt Guard	Yes	Yes	Yes	Yes	Yes	Yes	Yes
<b>Price</b>	<b>1,199<sup>99</sup></b>	<b>1,619<sup>99</sup></b>	<b>1,999<sup>99</sup></b>	<b>2,849<sup>99</sup></b>	<b>3,649<sup>99</sup></b>	<b>3,349<sup>99</sup></b>	<b>4,299<sup>99</sup></b>

## Premium Models



### 7.5 HP 80 Gallon 230V

SKU OUTSIDE BUY/EPO  
ABAC7-2180V2FF

**4,349<sup>99</sup>**

- Vertical 80 Gallon Tank
- Horsepower: 7.5 HP
- Power Supply (V/Ph): 230V/1
- CFM @ Max. psi: 24
- Max. psi: 176



### 10 HP 120 Gallon 230V

SKU OUTSIDE BUY/EPO  
ABAC10-23120VFF

**5,349<sup>99</sup>**

- Vertical 120 Gallon Tank
- Horsepower: 10 HP
- Power Supply (V/Ph): 230V/3
- CFM @ Max. psi: 32
- Max. psi: 176

Premium Models Include: Low Oil Level Shut Off, Auto Tank Drain and Belt Guard Aftercooler

## Rotary Screw Compressors

Rotary Screw Compressors are an Ideal Solution for Applications Where There is Continuous Demand for Dependable Compressed Air



- High Performance with Low Energy Consumption
- Low Noise and Vibration Levels
- Fully Integrated Aluminum Block

### 10 HP 131 Gallon 150 psi Screw Compressor with Dryer

SKU OUTSIDE BUY/EPO  
ABAAS-10503TMD

**8,499<sup>99</sup>**

- 208V-230V-460V/3PH
- 34.1 CFM

### 15 HP 131 Gallon 150 psi Screw Compressor with Dryer

SKU OUTSIDE BUY/EPO  
ABAAS-15503TMD

**11,549<sup>99</sup>**

- 208V-230V-460V/3PH
- 46.4 CFM

### 7.5 HP 131 Gallon 150 psi Screw Compressor

SKU OUTSIDE BUY/EPO  
ABAAS-75501TM

**6,849<sup>99</sup>**

- 230V/1PH
- 27.1 CFM

ABAAS-10503TMD



ABAAS-75501TM



Customer Responsible For Offloading, Liftgate Service Available.

For Outside Buy/EPO, Call 901-300-4878

- Free Delivery in 48 Continental United States
- Specifications Subject to Change without Notice or Liability
- Equipment Lead Times and Shipping May Vary
- Customers Responsible for Offloading Equipment Upon Arrival
- Leasing Terms Available, Ask Your AutoZone® Commercial Sales Manager.

Prices subject to change without notice. Prices do not include applicable taxes, vehicles, tires, rims, installation or optional equipment as shown. Please do not return purchases to the store. For information regarding warranty, repair, or any questions or concerns, call 901-300-4878.

# AIR COMPRESSORS

FOR HELP with Selection, Confirm Availability and Ordering Instructions, Call 901-300-4878

AIR COMPRESSORS

## Regulators/Filters/Drains

### 5 Stage Desiccant Filter/Dryer

SKU 543076  
ARRC7612XL **499<sup>99</sup>**

- Includes: Gauge, Shut-Off Valve and (1) 1/2 Gallon of Desiccant
- Lowers the Dew Point to -30°F



### 1/2" Electronic Drain

SKU 543065  
ARR5804 **84<sup>99</sup>**

- Automatically Drains Compressor Tanks, Receiver Tanks or Filters
- 110 Volt
- 6' Power Cord



### Regulator with Gauge (1/4")

SKU 543086  
ARRR262G **44<sup>99</sup>**

- Adjustment Range is 5 to 125 psig
- Rated for 25 SCFM



### Filter Regulator Lubricator (1/2")

SKU 543075  
ARRC33354 **249<sup>99</sup>**

- Cleans, Dries and Lubricates Air Supply
- Operating Pressure Range: 5 to 125 psi
- 40 Micron Element
- 142 CFM

Extend the Life of Your Air Tools!



### Air Regulator with Gauge (1/2")

SKU 543091  
ARRR354G **69<sup>99</sup>**

- Adjustment Range is 5 to 125 psig
- Rated for 100 SCFM



### Filter/Regulator (1/2")

SKU 543071  
ARRB754G **89<sup>99</sup>**

- Operating Pressure Range 5 to 125 psi
- 40 Micron Element
- 3 Position Non-Rising Adjustment Knob



NAME	SKU	PART #	PRICE
Replacement Desiccant Silica Gel, 1 Quart	OSB/EPO	ARR34189	<b>21.99</b>

NAME	SKU	PART #	PRICE
Regulator with Gauge (3/8")	543088	ARRR353G	<b>69.99</b>

## BelAire

### 5 HP 60 Gallon 230V Air Compressor, Single Phase

SKU OUTSIDE BUY/EPO  
IMC4916V

**1,619<sup>99</sup>**

- 15.4 CFM @ 100 psi
- 165 psi Max. Pressure
- Cast Iron Cylinders
- 2 Stage Pump
- No Start-Up Kit Required
- High Flow Belt Guard
- Warranty: 2 Year Factory



### 5 HP 80 Gallon 230V Air Compressor, Single Phase

SKU OUTSIDE BUY/EPO  
IMC418V

**2,849<sup>99</sup>**

- 18 CFM @ 100 psi
- 175 psi Max. Pressure
- Solid Cast Iron 2 Stage Pump
- Magnetic Starter Included
- Fully Enclosed Belt Guard
- Warranty: 2 Year Factory



## Champion®

- 100% Cast Iron Pump with Alloy Steel Reed Valves
- Warranty: 1 Year Unit Parts and Labor, 2 Years Pump Parts and Labor

### 5 HP 80 Gallon RV Series VRV5-8

SKU OUTSIDE BUY/EPO  
CHCRV215AS01

**2,949<sup>99</sup>**

- 230V/1ph
- 17.0 CFM @ 175 psi
- 3600 RPM Motor, No Starter Needed

### 5 HP 80 Gallon RV Series VRV5-8 with Starter

SKU OUTSIDE BUY/EPO  
CHCRV215AS07

**3,399<sup>99</sup>**

- 230V/1ph
- 16.5CFM @ 175 psi
- 1800 RPM Motor with Magnetic Starter



CHCRV215AS07

## Refrigerated Dryers

- Removes Condensate and Vapor So Dry Compressed Air is Produced in a Continuous, Cost-Efficient Way

### Cool 15 CFM

SKU OUTSIDE BUY/EPO  
ABAC00L15

**844<sup>99</sup>**

### Cool 25 CFM

SKU OUTSIDE BUY/EPO  
ABAC00L25

### Cool 25 CFM

SKU OUTSIDE BUY/EPO  
ABAC00L25

**1,049<sup>99</sup>**

### Cool 35 CFM

SKU OUTSIDE BUY/EPO  
ABAC00L35

**1,269<sup>99</sup>**



## Mi-T-M

### 30 Gallon Air Compressor/Generator

SKU OUTSIDE BUY/EPO  
MTMAG2SM1430ME

**3,099<sup>99</sup>**

- CFM @ 175 psi 15.7
- Max. AC Output: 4000 Watts
- Continuous with Compressor On Load 2300 Watts
- Continuous with Compressor Off Load 3500 Watts
- Receptacles 2 NEMA 5-20R, 1 NEMA L6-20R
- Displacement/Engine 420cc Mi-T-M OHV
- Compressor Two Stage, Cast Iron Pump



Customer Responsible For Offloading, Liftgate Service Available.

For Outside Buy/EPO, Call 901-300-4878

- Free Delivery in 48 Continental United States
- Specifications Subject to Change without Notice or Liability
- Equipment Lead Times and Shipping May Vary
- Customers Responsible for Offloading Equipment Upon Arrival
- Leasing Terms Available, Ask Your AutoZone® Commercial Sales Manager.

Prices subject to change without notice. Prices do not include applicable taxes, vehicles, tires, rims, installation or optional equipment as shown. Please do not return purchases to the store. For information regarding warranty, repair, or any questions or concerns, call 901-300-4878.

AZG0125

67

# LIGHTING

## Work Lights

Multi-Application Work Lights Deliver Functionality of Several Lights in Just One Versatile Light

**330 Lumens**  
SKU 105560  
24605 **44<sup>99</sup>**

- 4 Hr. Runtime on High

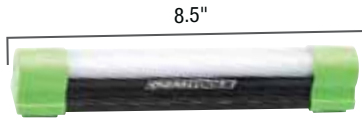

**360 Lumens**  
SKU 603726  
24695 **29<sup>99</sup>**

- 3.5 Hr. Runtime on High



**STORE STOCKED**

**600 Lumens**  
SKU 822266  
25997 **54<sup>99</sup>**

- 6 Hr. Runtime on High



**1000 Lumens**  
SKU 850228  
24604 **99<sup>99</sup>**

- 9 Hr. Runtime on High



- 5 Light Modes**  
High  
Medium  
Low  
Strobe  
SOS

**OEM TOOLS**

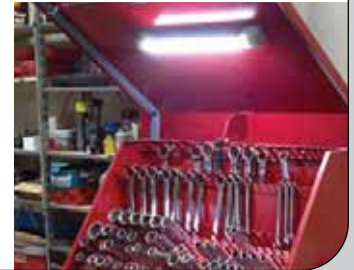

## Inspection Lights

**Mechanics 500 Lumen Rechargeable Flashlight and 450 Lumen Ultra Slim Wand with UV Inspection**

SKU 344835  
24607 **59<sup>99</sup>**

- 5 Light Modes: 100%, 50%, 25%, Strobe and SOS
- Flashlight Head Can Be Removed and Replaced with the Slim Inspection Light (as Shown)
- 3 Powerful, UV LED Lights on Inspection Light Detect Leaks Quickly and Easily

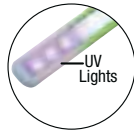
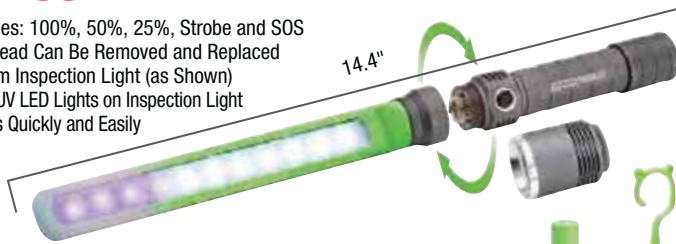

**MAX OUTPUT 500 LUMENS**

**3.5 hrs MAX RUNTIME**

Battery Includes Hook

**OEM TOOLS**



USB Rechargeable



**Pivoting Ultra-Slim 300 Lumen Work Light**

SKU 603727  
24696 **27<sup>22</sup>**

- Ultra-Slim Body Design Pivots 180° Providing More Light to Any Work Area
- Magnetic Base Attaches to Any Ferrous Surface
- 4 Light Modes: High, Low, Top Light and Handle Spotlight
- Top Light Illuminates the Tightest Work Areas
- 3 AAA Batteries Included

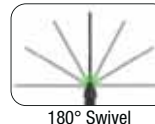
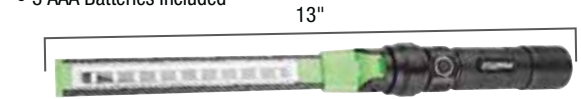

**MAX OUTPUT 300 LUMENS**

**15 hrs MAX RUNTIME**

**STORE STOCKED**

**700 Lumen Rechargeable COB LED Slim Inspection Light**

SKU 418752  
24646 **19<sup>99</sup>** REG. \$29.99

**SAVE \$10**

- Unique Variable Dial Lets You Control Output (0 to 700 Lumens)
- Runtime: 10 Hours (at 50% Power), 2.5 Hours (at 100% Power)
- Removable Magnetic Base with 360° Swivel and Lock Feature Lets You Adjust Angle to Point Light Where it's Needed



Offer Good Through March 31, 2025

**MAX OUTPUT 700 LUMENS**

**10 hrs MAX RUNTIME**

**OEM TOOLS**

**Periscope LED Flashlight**

SKU 526504  
25458 **25<sup>99</sup>**

- Chip On-Board LED
- Beam Distance: 2 Meters
- IPX-4 Water Resistant
- Includes: Magnetic Base to Stand Upright and 2 AA Duracell Batteries



**WATER RESISTANT IPX-4**

**2 AA**

**Dual Light COB LED Slimline Motion Sense Headlamp**

SKU OUTSIDE BUY/EPO  
SPLSP81491 **39<sup>99</sup>**

- Motion Sense On/Off: Easily Turn the Headlamp On and Off by Simply Swiping Your Hand in Front of the Motion Sensor
- Battery: 3.7v 1200 mAh Li-Polymer, Fast Charging USB Type C

**Wide Band Floodlight**

- Setting 1 - 350 Lumens - 2.5 Hours Runtime
- Setting 2 - 120 Lumens - 3.5 Hours Runtime

**Side Beam Spot Light**

- Setting 1 - 120 Lumens - 4 Hours Runtime
- Setting 2 - 45 Lumens - 6 Hours Runtime



**230° Wide Angle Floodlight Illuminates Entire Field of View**

For Outside Buy/EPO, Call 901-300-4878

**Tire Kicker with Flashlight**

SKU OUTSIDE BUY/EPO  
74217 **39<sup>99</sup>**

- Water Resistant
- 130 Meter Beam Distance
- 3 AA Batteries Included
- Length: 16.25"
- Diameter: 1.25"



For Outside Buy/EPO, Call 901-300-4878

**MAX OUTPUT 150 LUMENS**

**30 hrs MAX RUNTIME**

**GreatNeck**

**3-in-1 Multi-Use Rechargeable Diagnostic Under-the-Hood Work Light**

SKU 591153  
24609 **79<sup>99</sup>**

- 5.5 Hr. Runtime on High



**MAX OUTPUT 400 LUMENS**

**5.5 hrs MAX RUNTIME**

**OEM TOOLS**



## Underhood Lights

### 1,500 Lumen LED

SKU 1414960  
ATD80050A **154<sup>99</sup>**

- 25 Ft. Cord Remains Flexible in Extreme Cold
- Rubber Covered Telescoping Brackets For Use on Hoods from 47" to 75" Wide



### 2,000 Lumen LED Corded/Cordless

SKU 1414959  
ATD80357 **199<sup>99</sup>**

- 40" Light Bar Provides 2000 Lumens of Bright Light
- Hooks Extend 55" to 83" to Fit New SUVs and Light Trucks
- 25' Removable Cord Remains Flexible in Cold Weather
- 2 Modes: High-2000 Lumens/Low-1000 Lumens
- 5200 mAh Li-ion Battery Provides Up to 2 Hours (High), Up to 4 Hours (Low) Runtime



## Cord Reel

### 50' Retractable Extension Cord Reel

SKU 1105991  
LEGFZ8140503 **199<sup>99</sup>**

- Circuit Breaker with Reset Button Prevents Breaker Trip or Blown Fuses
- Oil-Resistant 14/3 AWG SJTOW Cord
- Lighted Triple Tap Outlet



## Streamlights

### Stinger LED with AC/DC

SKU 291368  
STL75732 **249<sup>99</sup>**

- 425 Lumens
- Runtime: 10 Hours
- Beam Distance: 322 Meters
- Four Lighting Modes: High, Medium, Low and Strobe



### Stylus Pro with White LED



- 48 Lumens
- Runtime: 7.5 Hours
- Waterproof Construction with an Unbreakable Polycarbonate Lens Pocket Clip

#### Blue

SKU 291362  
STL66122 **36<sup>99</sup>**

#### Red

SKU 291358  
STL66120 **36<sup>99</sup>**

#### Black

SKU 291408  
STL66118 **36<sup>99</sup>**

#### Silver

SKU 291359  
STL66121 **36<sup>99</sup>**



## Pen Lights

### Cree LED Pen Light

- 3 Modes: Low (50 Lumens), High (150 Lumens) and Strobe
- 80 Meter Beam Distance
- Anodized Aluminum Body is Impact and Water Resistant
- Battery Runtime: 6 Hours (Low), 3 Hours (High)
- Comes with 2 AAA Batteries and Tactical Clip

MAX OUTPUT  
**150 LUMENS**  
MAX RUNTIME  
**6.0 hrs**

#### Red

SKU 592188  
32838

#### Silver

SKU 592183  
32839

#### Black

SKU 592184  
32835

#### Blue

SKU 592185  
32836

**19<sup>99</sup>** each



2 AAA

# SYLVANIA

#1 AFTERMARKET AUTOMOTIVE LIGHTING BRAND IN THE USA<sup>1</sup>

<sup>1</sup>Circana/U.S. Retail Tracking Service, March 2, 2024  
<sup>2</sup>See packaging for details <sup>3</sup>Compared to SYLVANIA BASIC

LED OFF ROAD LIGHTBARS + PODS



## SYLVANIA LED OFF ROAD LIGHTS



### LIFETIME LIMITED WARRANTY<sup>2</sup>

Superior optical engineering  
Durable design  
Water resistant (IP67 or IP69K)

UPGRADE YOUR HEADLIGHTS

### SYLVANIA LED



#### 5 YEAR LIMITED WARRANTY<sup>2</sup>

Performance, Longevity + Style

PART NUMBERS:  
9003 | 9005 | 9006 | 9007 |  
9012 | H1 | H7 | H8 | H9 |  
H11 | H13 | H16

For powersports or fog use only.

### SILVERSTAR ULTRA



#### FARTHEST DOWNROAD + WHITER LIGHT<sup>3</sup>

COLOR MOST DOWNROAD<sup>3</sup>  
MORE CLARITY<sup>3</sup> FOR ULTRA NIGHT VISION

### SILVERSTAR



#### FARTHER DOWNROAD + WHITER LIGHT<sup>3</sup>

COLOR MOST DOWNROAD<sup>3</sup>  
MORE CLARITY<sup>3</sup>

### XTRAVISION



#### FARTHEST DOWNROAD<sup>3</sup>

COLOR MOST DOWNROAD<sup>3</sup>

EXPERIENCE THE DIFFERENCE OF

# LED



## NEW! SYLVANIA LED SEALED BEAM LAMPS

5 Year Limited Warranty<sup>2</sup>  
Direct replacement  
DOT compliant  
Engineered with OEM grade OSRAM LEDs

Available Part Numbers: H6024 | H6054  
Additional part numbers coming soon



HALOGEN  
SYLVANIA BASIC



LED  
SYLVANIA LED

# LIGHTING

## Flashlights



### Rechargeable Multi-Head All-in-One Work Light Kit

SKU 765525  
24648 **79<sup>99</sup>**

- Quick-Attachment Coupler Allows for Easy Accessory Transition Between 3 Interchangeable Heads

**Comes with USB Charging Cord, AC Adapter, 180° Swivel Hook and (1) 18650 Rechargeable Battery**



### Work Lamp Attachment for 24648 Work Light Set

SKU 884377  
24648E **14<sup>99</sup>**

### Magnetic Rechargeable LED Work Light

SKU 819644  
25982 **59<sup>99</sup>**

- 3W COB LED, Super Bright White Lights: 400 Lumens
- 3.7V 2200 mAh Li-ion Battery
- Runtime: 3 Hrs. (Work Light), 9 Hrs. (Torch Light)
- Powerful Magnets on the Back and Swivel Base
- Includes: USB Cable for Recharging



**Swivels, Hangs, or Sticks**



### 2-in-1 Rechargeable Pocket Light

SKU 081751  
26029 **19<sup>99</sup>**

- 2-in-1 Pocket Light: Super Bright COB LED Work Light with Integrated LED Flashlight
- Easy Hands-Free Operation with Magnetic Base and Magnetic Pocket Clip
- Max. Output (Work Light): 200 Lumens
- Max. Output (Flashlight): 140 Lumens
- Max. Runtime: 3 Hrs.



120° Rotating Magnetic Clip



### 500 Lumen Tactical LED Flashlight

SKU 1368622  
74219 **24<sup>99</sup>**

- 2 Light Modes: 500 Lumens (High), 50 Lumens (Low)
- Beam Distance: 150 Meters
- IPX-5 Water Resistant



3 AAA



### E54 Cree 700 Lumens Tactical Flashlight

SKU 347200  
EXPE54 **59<sup>99</sup>**

- Water and Shock Resistant Aluminum Body
- No-Slip Grip Surface
- Beam Distance: 300 Meters



Requires 2 or 4 CR123A Batteries Not Included



### Charging Unit for (1) 18650 Battery

SKU 347209  
EXPE02 **39<sup>99</sup>**

- (1) 18650 Battery Included



For Use with: EXPE36-E02 and EXPE54

## E36 Cree Rechargeable Flashlight Kit

SKU 568461  
EXPE36-E02

**59<sup>99</sup>**  
REG. \$69.99

**SAVE \$10**

**MAX OUTPUT 1000 LUMENS**



Includes:  
(1) 18650 Battery and Charger



**GreatLite**



**2.0 hrs MAX RUNTIME**

**WATER RESISTANT IPX-6**

**IMPACT RESISTANT**

**Li-ion**

**SST 40 LED BULB**

Offer Good Through March 31, 2025

## 1/2" Impact Wrenches

### Heavy Duty 1/2" Composite Stubby Impact Wrench

SKU 087596 24418 **159<sup>99</sup>**

- Torque: 900 Ft/Lb.
- Includes (7) 1/2" Short Impact Sockets Sizes: 13 mm to 19 mm
- Custom Cut EVA Foam Storage Tray
- CFM: 4.0



WARRANTY: 1 Year

OEM TOOLS

EVA FOAM TRAY



### 1/2" Extended Anvil Impact Wrench

SKU 1282755 KNGNC-4265Q **279<sup>99</sup>**

- 1200 Ft/Lb. Reverse Torque
- 200 to 800 Ft/Lb. of Torque
- 8500 Free Speed RPM
- 85 dBA



WARRANTY: 3 Years

### 1/2" Impact Wrench

SKU 592249 KNGNC-4232Q **209<sup>99</sup>**

- Mighty Small, Mighty Powerful Air Impact Wrench
- Max. Reverse Torque: 700 Ft/Lb.
- 85 dBA Noise Level Exceeds OSHA Standards
- Ultra Lightweight at Less Than 3 Lb.
- Twin Hammer Mechanism



WARRANTY: 3 Years

### 1/2" Impact Wrench

SKU 970487 IRT231HA **224<sup>99</sup>**

- Torque: 590 Ft/Lb.
- Pressure-Fed Lubrication System
- In-Handle Exhaust Directs Away from User
- Industry Standard for 3 Decades
- Sound Pressure: 94 to 105 dBA



WARRANTY: 1 Year

IR Ingersoll Rand

### 1/2" Super Duty Air Impact Wrench with Extended Anvil

SKU 604744 IRT231HA2 **259<sup>99</sup>**

- Max. Torque: 590 Ft/Lb.
- In-Handle Exhaust Directs Air Away from User
- Pressure-Fed Lubrication System



WARRANTY: 1 Year

IR Ingersoll Rand

### 1,200 Ft/Lb. Impact Wrench with Patent Oil Filled Anvil

SKU 1105334 KNGNC-4255QHB **244<sup>99</sup>**

- Max. Reverse Torque of 1,200 Ft/Lb. is Reached in 5 Seconds
- Longer Periods of Peak Power
- Patented Greaseable Anvil
- 85 dBA at 90 psi



WARRANTY: 3 Years

m7

### 1/2" Air Impact Wrench Classic

SKU 495316 IRT231C **189<sup>99</sup>**

- Original Twin Hammer Impact
- Torque: 600 Ft/Lb.
- Pressure-Fed Lubrication
- Adjustable Power Regulator
- 1/2" Square Drive



WARRANTY: 1 Year

IR Ingersoll Rand

### 1/2" Thundergun Street Legal™ Impact Wrench

SKU 495318 IRT232TGSL **284<sup>99</sup>**

- Torque: 625 Ft/Lb.
- 10,000 RPM for Lightning Fast Removal is Best-In-Class



WARRANTY: 1 Year

IR Ingersoll Rand

### 1/2" Quiet Impact Wrench

SKU 738489 IRT2135QXPA **349<sup>99</sup>**

- Torque: 780 Ft/Lb.
- Light, Quiet and Powerful Impact
- Twin Hammer Mechanism
- Weighs Only 4 Lb.



WARRANTY: 1 Year

IR Ingersoll Rand

### 1/2" Titanium Air Impact Wrench

SKU 695134 IRT2235TIMAX **479<sup>99</sup>**

- Torque: 1,350 Ft/Lb.
- Reverse Torque: 930 Ft/Lb.
- Twin Hammer Impact Mechanism
- Lightweight



WARRANTY: 1 Year

IR Ingersoll Rand

### 1/2" Titanium Air Impact Wrench with Extended Anvil

SKU 738490 IRT2235TIMAX2 **469<sup>99</sup>**

- Torque: 1,350 Ft/Lb.
- Max. Reverse Torque: 930 Lb.
- 8,500 Free Speed RPM
- Titanium Hammercase



WARRANTY: 1 Year

IR Ingersoll Rand

## 3/8" Impact Wrenches

### 3/8" Titanium Impact Wrench

SKU 198065 IRT2115TIMAX **319<sup>99</sup>**

- Torque: 300 Ft/Lb.
- Feather Touch Trigger and Patented Push Button Forward/Reverse



WARRANTY: 1 Year

IR Ingersoll Rand

### 3/8" Mini Air Impact Wrench

SKU 1125881 KNGNC-3612Q **174<sup>99</sup>**

- Maximum Reverse Torque Can Reach Up to 350 Ft/Lb. in 5 Seconds
- Low Noise Sound Level 85 dBA



WARRANTY: 3 Years

m7

## 3/4" Impact Wrench

### 3/4" Composite Impact Wrench

SKU 477102 IRT2145QIMAX **734<sup>99</sup>**

- Max. Reverse Torque: 1,350 Ft/Lb.
- Compact Design Fits Easily into Small Spaces
- Air Consumption CFM: 8.5
- Compact and Lightweight (Only 7.4 Lb.)



WARRANTY: 1 Year

IR Ingersoll Rand

# AIR TOOLS

## Air Sanders

### 2" Surface Prep Air Sander

SKU 094650 **54<sup>99</sup>**  
25778

- Includes Quick Change "Twist Lock" Mandrel
- Free Speed: 20,000 RPM
- Average Air Consumption: 3.2 CFM
- Air Inlet Thread Size: 1/4" NPT

WARRANTY: 1 Year



### Heavy Duty Reciprocating Air Saw

SKU 802225 **99<sup>99</sup>**  
24409

- Recommended Air Pressure: 90 psi
- Air Consumption: 1.7 CFM
- Strokes per Minute: 9,000 SPM
- Air Inlet Thread Size: 1/4" NPT
- Lightweight: 1.50 Lb. (0.70 kg)
- Length: 10.6" (270 mm)
- Exhaust: Front
- Enhanced Blade Guard Design and Trigger Safety Lock
- Includes: Reciprocating Air Saw, 2 Hex Key Wrenches, 2 Saw Blades and 2 Blade Guards

WARRANTY: 1 Year



### 6" Dual Action Sander

SKU 970475 **109<sup>99</sup>**  
IRTIR311A

- Dual Action Pad Motion Reduces Swirl
- Built-In Silencer for Quiet Operation

WARRANTY: 1 Year



### Straight Line Sander

SKU 970479 **184<sup>99</sup>**  
IRTIR315

- Twin Piston Design for Smooth Operation
- 3,000 Strokes per Minute
- Quick-Action Paper Clamps

WARRANTY: 1 Year



### Heavy Duty Mini Surface Prep Kit

SKU 087620 **79<sup>99</sup>**  
24417

- 2" and 3" Heavy Duty Mini Air Surface Prep Sander
- (1) 2" Backer Pad and (1) 3" Backer Pad
- (2) 2" and (2) 3" Medium Grit Surface Prep Discs
- (2) 2" and (2) 3" Coarse Surface Prep Discs
- (2) 2" and (2) 3" Sander Discs
- Blow Mold Case

WARRANTY: 1 Year



## 1/4" Die Grinders

### Mini Air Die Grinder

SKU 751631 **44<sup>99</sup>**  
24404

- Air Consumption: 2.4 CFM
- Free Speed: 25,000 RPM
- Recommended Air Pressure: 90 psi

WARRANTY: 1 Year



Composite Body with Built-In Silencing to Reduce Noise Level

### 1/4" Air Die Grinder

SKU 802212 **29<sup>99</sup>** **SAVE \$20**  
24406 REG. \$49.99

- Air Consumption: 3.4 CFM
- Free Speed: 22,000 RPM
- Recommended Air Pressure: 90 psi
- Exhaust: Rear 360°

WARRANTY: 1 Year

Offer Good Through March 31, 2025



### Extended Air Die Grinder

SKU 802216 **89<sup>99</sup>**  
24408

- Air Consumption: 2.5 CFM
- Free Speed: 23,000 RPM
- Recommended Air Pressure: 90 psi

WARRANTY: 1 Year



(Color May Vary)

### Mini Air Die Grinder

SKU 802211 **49<sup>99</sup>**  
24405

- Air Consumption: 3.4 CFM
- Free Speed: 25,000 RPM
- Recommended Air Pressure: 90 psi

WARRANTY: 1 Year



### 1/4" Mini Angle Die Grinder and Surface Prep Kit

SKU 94648 **159<sup>99</sup>**  
25777

- Air Consumption: 4 CFM
- Free Speed: 20,000 RPM
- Grinding and Cleaning All-in-One Kit
- Comes in a Heavy Duty Plastic Tray

WARRANTY: 1 Year



## 1" Impact Wrench

### 1" Impact Wrench with Extended Anvil

SKU 970474 **879<sup>99</sup>**  
IRTIR285B6

- Reverse Torque: 1,770 Ft/Lb.
- 6" Anvil for Better Truck Wheel Nut Accessibility
- Hi-Efficiency Motor

WARRANTY: 1 Year



## Air Drill

### 3/8" Quiet Reversible Air Drill

SKU 1189089 **144<sup>99</sup>**  
KNGQE-833

- Sound Level: 83 dBA
- Ergonomic Rubber Grip
- Variable Speed Trigger
- Aluminum Body
- Convenient Forward/Reverse Control Lever
- Free Speed: 1,800 RPM

WARRANTY: 3 Years





# AIR TOOLS

TO ORDER, contact your Commercial Sales Manager or go to [AutoZonePro.com](http://AutoZonePro.com)

AIR TOOLS

## 1/4" Air Ratchets

### 1/4" Super Duty Air Impact Ratchet

SKU 850508 **49<sup>99</sup>**  
24415

**Impact Mechanism Adds Power and Prevents Kickback**

- Max. Torque: 50 Ft/Lb.
- Free Speed: 700 RPM
- CFM: 3.1 @ 90 psi
- Length: 6.5"
- Sealed Head Ratchet Housing Prolongs Tool Life
- Compact and Lightweight
- Most Power-to-Weight Ratio
- Rear Air Exhaust: 360° Adjustable



Composite Body

WARRANTY: 1 Year



### 1/4" Drive Industrial Air Ratchet

SKU 466593 **59<sup>99</sup>**  
25763

- Max. Torque: 18 Ft/Lb.
- Free Speed: 240 RPM
- Average Air Consumption: 3.0 CFM
- Recommended Air Pressure: 90 psi



WARRANTY: 1 Year

OEM TOOLS

## 3/8" Air Ratchets

### 3/8" Air Ratchet

SKU 970485 **149<sup>99</sup>**  
IRTIR107XPA

- Max. Torque: 54 Ft/Lb.
- Advanced Head Design
- 360° Adjustable Exhaust



WARRANTY: 1 Year

IR Ingersoll Rand

### 3/8" Air Ratchet Wrench

SKU 662908 **144<sup>99</sup>**  
KNGNE-343

- Max. Reverse Torque: 75 Ft/Lb.
- Forward Working Torque: 10 to 55 Ft/Lb.
- Free Speed: 160 RPM



WARRANTY: 3 Years

m7

### 3/8" Super Duty Air Impact Ratchet

SKU 850055 **99<sup>99</sup>**  
24416

- Max. Torque: 50 Ft/Lb.
- Free Speed: 700 RPM
- CFM: 3.1 @ 90 psi
- Length: 6.5"
- Sealed Head Ratchet Housing Prolongs Tool Life
- Compact and Lightweight
- Most Power-to-Weight Ratio
- Rear Air Exhaust



WARRANTY: 1 Year

OEM TOOLS



## Air Hammers

### Standard Duty Air Hammer

SKU 1392327 **109<sup>99</sup>**  
IRT117

- 2,000 Blows per Minute
- Heat-Treated Piston and an Alloyed Steel Barrel



WARRANTY: 1 Year

### 121Q Super Duty Air Hammer

SKU 478945 **159<sup>99</sup>**  
IRT121Q

- Ideal for Body Panel Crimping and Cutting, Bushing Driving, Shearing and General Front End Work
- Built-In Power Regulator and Trigger Control
- Easy to Control with an "Easy Out" Throttle



WARRANTY: 1 Year

IR Ingersoll Rand

## Cut-Off Tools

### Air Reciprocating Saw

SKU 970481 **149<sup>99</sup>**  
IRTIR429

- Designed for Cutting Intricate Shapes
- Cuts Flat and Curved Surfaces
- Comes with 6 High Speed Steel Cutting Blades



WARRANTY: 1 Year

IR Ingersoll Rand

### 3" Air Cut-Off Tool

SKU 466590 **29<sup>99</sup>** REG. \$39.99  
25760

- Air Inlet Thread Size: 1/4" NPT
- Free Speed: 22,000 RPM
- Recommended Air Pressure: 90 psi

SAVE \$10



WARRANTY: 1 Year

Offer Good Through March 31, 2025

OEM TOOLS

## Inflators

### Digital Tire Inflator

SKU 802198 **69<sup>99</sup>**  
24412

- Easy-to-Read Backlit LCD Display
- 4 Units of Measure (psi, Bar, KPa, kgf)
- Measuring Range: 0 to 175 psi (0 - 12 Bar)
- Accuracy: +/-1.2 psi Up to 58 psi, +/-2.3 Between 58 psi and 145 psi Inclusive, +/-3.6 psi Greater Than 145 psi
- High Air Flow Saves the Technician Time
- Includes: 2 AAA Batteries



OEM TOOLS

### Dial Tire Inflator

SKU 301772 **59<sup>99</sup>**  
24380

- Clear and Easy-to-Read 80 mm 180 psi Gauge
- 3-In-1 Function: Inflate, Deflate and Measure Tire Pressure
- Increased Accuracy to Improve Tire Performance and Prevent TPMS Comebacks



OEM TOOLS

### 3.5" Digital Tire Inflator with Hose

SKU 1268419 **129<sup>99</sup>**  
AST3018

- 21" Stainless Braided Hose
- Dual AAA Battery Powered Design
- Backlit LCD Digital Read-Out
- Includes Batteries



Astro

### Inflator Gauge, Dual Head Chuck Tire Inflator Gauge

SKU OUTSIDE BUY/EPO **74<sup>99</sup>**  
MILS506

- Heavy Duty Construction Provides for Long Life Even Under Heavy Use and Extreme Conditions
- Gauge and Valve Cartridges are Replaceable
- Equipped with Magnifying Lens for Full View of Scale



MILTON INDUSTRIES, INC.

For Outside Buy/EPO, Call 901-300-4878

Prices subject to change without notice. Prices do not include applicable taxes, vehicles, tires, rims, installation or optional equipment as shown. Please do not return purchases to the store. For information regarding warranty, repair, or any questions or concerns, call 901-300-4878.

AZG0125

73

# AIR TOOL ACCESSORIES

## Impact Sockets and Extensions

### 1/2" Drive Impact Extension Set

SKU 1340235 **99<sup>99</sup>**  
SUN2500

- Set Includes: 1/2" Dr. 3", 5", 10" and 15" Impact Extensions
- Comes in a Blow Mold Case



### 3/8" Impact Sockets

- 6 Pt. High Quality Impact Sockets
- SAE: 5/16", 3/8", 7/16", 1/2", 9/16", 5/8", 11/16", 3/4", 13/16", 7/8", 15/16" and 1"
- Metric: 8, 9, 10, 11, 12, 13, 14, 15, 16, 17, 18 and 19 mm

**Posi-Grip No Slip™ Design Provides Superior Gripping Power for Maximum Torque**  
**Chrome Moly Steel Construction for Strength and Durability**

### 12 Piece Shallow (SAE)

SKU 391191  
25589  
**29<sup>99</sup>**

### 12 Piece Shallow (Metric)

SKU 391190  
25587  
**29<sup>99</sup>**



### 12 Piece Deep (SAE)

SKU 442193  
25590  
**39<sup>99</sup>**

### 12 Piece Deep (Metric)

SKU 464314  
25588  
**39<sup>99</sup>**



### 33 mm 1" Drive Budd Style Wheel Socket

SKU 466569 **19<sup>99</sup>**  
25528

- 1" Drive 33 mm Budd Wheel Socket for Mack, Midliner, Volvo, White and Other Import Trucks with Dual Rear Wheels



### 1/2" Impact Sockets

- 6 Pt. High Quality Impact Sockets
- SAE: 3/8", 7/16", 1/2", 9/16", 5/8", 11/16", 3/4", 13/16", 7/8", 15/16" and 1"
- Metric: 10, 11, 12, 13, 14, 15, 16, 17, 18 and 19 mm



### 11 Piece Shallow (SAE)

SKU 391195  
25593  
**32<sup>99</sup>**

### 10 Piece Shallow (Metric)

SKU 391192  
25591  
**29<sup>99</sup>**



### 11 Piece Deep (SAE)

SKU 391196  
25594  
**42<sup>99</sup>**

### 10 Piece Deep (Metric)

SKU 391194  
25592  
**39<sup>99</sup>**



### 1-1/2" Hex x 13/16" Square Deep 1" Drive Budd Style Wheel Socket

SKU 466570 **24<sup>99</sup>**  
25529

- For Budd Wheel 1-1/2" Hex with 13/16" Inside Square



## Impact Adapters



### 5 Piece Adapter and Universal Joint Set (3/8" and 1/2")

SKU 965864 **34<sup>99</sup>**  
24226

- Chrome Moly Steel Construction
- Includes: 3/8" Drive Universal Joint, 3/8" Drive (F) x 1/2" (M) Adapter, 1/2" Drive Universal Joint, 1/2" Drive (F) x 3/8" (M) Adapter and 1/2" Drive (F) x 3/4" (M) Adapter



## Air Blow Gun



### 5 Piece Interchangeable Tip Air Blow Gun

SKU 338823 **21<sup>99</sup>**  
24439

- Includes 4 Interchangeable Tips: 100 mm (4"), 140 mm (5.5"), 320 mm (12.5") and a Turbo Wide Angle Nozzle
- Quick Change Coupling Makes it Easy to Change Tips
- Wide Angle Nozzle for High Volume
- Variable Trigger to Control Volume and Tip Pressure
- 1/4" NPT Air Inlet

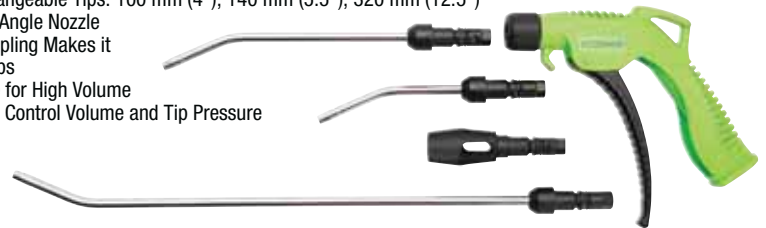

## High Flow Couplers

### High Flow Coupler and Plug Kits

- Ideal for HVLP Spray Guns and High Torque Impact Wrenches
- Delivers the Highest Air Volume with the Lowest Pressure Drop

**70% MORE FLOW\***

### 14 Piece 1/4" Body, 1/4" NPT

SKU 757091 **21<sup>99</sup>**  
26134



### 7 Piece 1/4" Body, 1/4" NPT

SKU 757040 **13<sup>99</sup>**  
26132



\*When Paired Together, OEMTOOLS High Flow Couplers and Plugs Deliver Up to 70% More Flow than Conventional Couplers

Prices subject to change without notice. Prices do not include applicable taxes, vehicles, tires, rims, installation or optional equipment as shown. Please do not return purchases to the store. For information regarding warranty, repair, or any questions or concerns, call 901-300-4878.

# AIR TOOL ACCESSORIES

TO ORDER, contact your Commercial Sales Manager or go to [AutoZonePro.com](http://AutoZonePro.com)

AIR TOOL ACCESSORIES

## Hoses and Hose Reels

### 50' Nitrile Rubber

- Lays Flat Under Pressure for Easy Maneuverability and Safety
- Meets PFAS-Free Regulations
- Resists Abrasions and Kinks
- UV Protective Material
- Excellent Resistance to Grease, Oil and Weather



**LINCOLN**

**3/8"**  
SKU OUTSIDE BUY/EPO  
LIN72N3850  
**54<sup>99</sup>**

- 1/4" NPT Brass Fittings

**1/2"**  
SKU OUTSIDE BUY/EPO  
LIN72N1250  
**84<sup>99</sup>**

- 1/2" NPT Brass Fittings

### 50' Premium Hybrid

- Lightweight Design for Ease of Use and Enhanced Portability
- Kink Resistant with All-Weather Flexibility (-40 to 150 Degrees F)

**3/8"**  
SKU OUTSIDE BUY/EPO  
LIN72H3850  
**54<sup>99</sup>**

- 1/4" NPT Brass Fittings

**1/2"**  
SKU OUTSIDE BUY/EPO  
LIN72H1250  
**84<sup>99</sup>**

- 1/2" NPT Brass Fittings

For Outside Buy/EPO, Call 901-300-4878

### 100' Wall Mount Air Hose Reel

SKU 291343 **44<sup>99</sup>**  
25970

- Comes with 18" Leader Hose
- Mounts Solid or with Swivel Action
- Solid Steel Frame
- Some Assembly Required



### 3/8" x 50' Air Hose Reel

SKU 900815 **159<sup>99</sup>**  
25979

- Smooth Automatic Retracting Spring Coil
- 50' Hose
- 3/8" NPT Fittings
- Max. Pressure: 250 psi



(Color May Vary)

### 3/8" x 50' Hybrid Polymer Air Hose with Reel

SKU 347224 **124<sup>99</sup>**  
24424

- Heavy Duty Polymer Hose Material Redefines Flexibility - Stays Flexible Under All Weather Conditions (-40° to 150°F)
- Holds No Memory - Kink Resistant Under Pressure
- 300 psi Working Pressure
- Bend Restriction for Reducing Wear and Tear and Extending Life of Hose
- Solid Brass MNPT Ends



### 1/2" x 4' Air Hose

SKU 347221 **19<sup>99</sup>**  
24421

- 3/8" Swivel MNPT x 3/8" MNPT

### Value Series Air Hose Reel

- Retractable Delivery Hose
- Durable Heavy Gauge Steel Construction
- Slotted Mounting Base for Easy Installation

**3/8" x 50'**  
SKU 972284  
LIN83753  
**289<sup>99</sup>**

**1/2" x 50'**  
SKU 972285  
LIN83754  
**314<sup>99</sup>**



### 3/8" x 50' Air Hose Reel

SKU OUTSIDE BUY/EPO **209<sup>99</sup>**  
LEGL8250FZ

- Extreme All-Weather Flexibility, Even in Subzero Temperatures (-40° to 140°F)
- Won't Kink Under Pressure



For Outside Buy/EPO, Call 901-300-4878

## Air Piping

### MaxLine Compressed Air Piping System 3/4" Master Kit

SKU 360593 **259<sup>99</sup>**  
RAPM7500

**Aluminum Core: Holds Any Bent Shape!**

- Heavier Duty Components for Longer Air Runs in Larger Buildings
- 3 Air Outlets, (1) 3/4" NPT Straight Fitting, 2 Tees, 20 Clips and 100' of 3/4" HDPE Tubing



**RAPIDAIR**

### 1/2" Tubing Master Kit

SKU 360485 **159<sup>99</sup>**  
RAP90500

- Easily Install Behind Walls of New Construction or on Existing Shop Walls
- Includes: 2 Air Outlet Kits, 1 Compressor Manifold Kit, 100' Nylon Tubing and Tubing Cutter



### 3/4" MaxLine Outlet Kit

SKU OUTSIDE BUY/EPO  
RAPM7510  
**59<sup>99</sup>**

- 3/4" Outlet Kit for MaxLine Compressed Air System

For Outside Buy/EPO, Call 901-300-4878



## Air Chuck

### Dual Foot Air Chuck with Comfort Grip Handle

SKU 802201 **24<sup>99</sup>**  
24413

- Comfortable Screwdriver Style Handle
- 30° Reverse Angle Chuck Can Be Used on Outside Tires
- Tilt Lock Feature Locks onto the Valve



### Air Chuck with Comfort Grip Handle

SKU 802200 **19<sup>99</sup>**  
24414

- Durable, OEMTOOLS Screwdriver Style Handle for Comfort and a Positive Grip
- Sealed-Ball Air Chuck is Extended 1" from Handle to Allow Access to Tight Areas



See More RapidAir® Products on [AutoZonePro.com](http://AutoZonePro.com)

Prices subject to change without notice. Prices do not include applicable taxes, vehicles, tires, rims, installation or optional equipment as shown. Please do not return purchases to the store. For information regarding warranty, repair, or any questions or concerns, call 901-300-4878.

AZG0125

75

# AIR TOOL ACCESSORIES

## Surface Prep

### 2" Twist-to-Lock Surface Prep Discs (50 Pack) with Cookie Jar

**Coarse**  
SKU 1146029  
SHA13088  
**79<sup>99</sup>**

**Medium**  
SKU 1146030  
SHA13089  
**79<sup>99</sup>**



### Assorted

SKU 1168677  
SHA13087  
**49<sup>99</sup>** REG. 79.99

• Includes: Coarse, Medium and Fine  
Offer Good Through March 31, 2025

**SAVE \$30**



### 2" Surface Prep Discs (25 Pack)

- Twist-Lock Style

#### Coarse

SKU 1330684  
22517  
**19<sup>99</sup>** (0.79 each)

#### Medium

SKU 1335806  
22516  
**19<sup>99</sup>** (0.79 each)



### 3" Surface Prep Discs (25 Pack)

- Twist-Lock Style

#### Coarse

SKU 1335795  
22518  
**34<sup>99</sup>** (1.39 each)

#### Medium

SKU 1335787  
22519  
**34<sup>99</sup>** (1.39 each)



### Twist-Lock Disc Holders

SKU 1368617  
SHA13012  
**17<sup>99</sup>**

- 2" Holder (Single)

SKU 094911  
SHA323T2  
**29<sup>99</sup>**

- 2" Holder (2 Pack)

SKU 094916  
SHA333T2  
**29<sup>99</sup>**

- 3" Holder (2 Pack)



SKU 094912  
SHA323TB  
**29<sup>99</sup>**

- 2" and 3" Holder Set



### 2" Purple Strip Disc with Twist-Lock (5 Pack)

SKU 298097  
SHA16206  
**19<sup>99</sup>**

- Long-Life Silicon Carbide for Paint and Coating Removal
- Pack of 5 Discs



### 2" Twist-Lock Mini Flap Discs Assorted Grits (6 Pack)

SKU 306275  
SHA13056  
**39<sup>99</sup>**

- Outlasts Mini Grinding Discs by 3 Times
- Includes: 2 Each of 40, 60 and 80 Grit

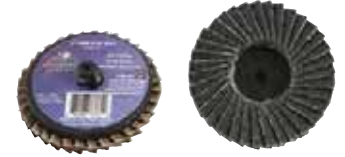

Ideal for Hard-to-Reach Surfaces and Lasts Longer than Most Abrasive Discs

### Finger Discs (10 Pack)

- Long Life Discs with Type "R" Style Backing
- Improved Surface Contact Over Wire Brushes
- Great for Rust, Surface Contamination and Oxide Removal from Metals



#### Finger Discs

SKU	Part #	Color	Size	Grit	Qty	Price
OSB/EPO	SHA13345	Green	1"	50G	10	<b>79.99</b>
1362005	SHA13347	Yellow	1"	80G	10	<b>79.99</b>
OSB/EPO	SHA13349	Gray	1"	120G	10	<b>79.99</b>
OSB/EPO	SHA13359	Gray	2"	120G	10	<b>99.99</b>
1362011	SHA13361	Green	3"	50G	10	<b>164.99</b>
1362013	SHA13363	Yellow	3"	80G	10	<b>164.99</b>
1362001	SHA13365	Gray	3"	120G	10	<b>164.99</b>

For Outside Buy/EPO, Call 901-300-4878

### Twist-to-Lock Green Zirconia Mini Grinding Discs

Green Zirconia					
SKU	Part #	Size	Grit	Qty	Price
306282	SHA12613	2"	36	25	<b>39.99</b>
305896	SHA12614	2"	50	25	<b>39.99</b>
204022	SHA12615	2"	80	25	<b>39.99</b>
306323	SHA12617	3"	36	25	<b>49.99</b>
305827	SHA12618	3"	50	25	<b>49.99</b>
204009	SHA12619	3"	80	25	<b>49.99</b>



## Cut-Off Accessories

### Mandrel Set for Cut-Off Tools (2 Pack)

SKU 094907  
SHA32  
**29<sup>99</sup>**



### 10 Piece Cut-Off Wheel Set with Mandrel

SKU 1400046  
26528  
**14<sup>99</sup>**

- Capable of Cutting Fiberglass, Plastic, Iron, Steel and Other Ferrous Metals
- Quantity: (10) 3" x 1/16" Cut-Off Wheels with 3/8" Arbor, 46 Grit
- Max. RPM: 20,400

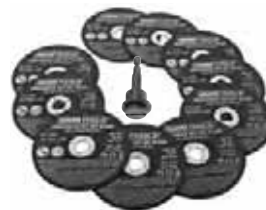

### 3" Aluminum Cutting Wheels (10 Pack)

SKU 306331  
SHA13178PK2  
**59<sup>99</sup>**

- Silicon Carbide Grain
- Includes: (10) 3" x 1/16" x 3/8"
- Works on 3" Die Grinders



### 3" x 1/16" x 3/8" Reinforced Cut-Off Wheels (25 Pack)

SKU 306273  
SHA25E5PK5  
**44<sup>99</sup>**

- For Use with Pneumatic Cut-Off Tools
- Max. RPM: 25,000
- Includes: 25 Discs



## Professional OEMTOOLS®

20V Max\* Li-ion  
**Heavy Duty 1/2" Impact Wrench**  
 SKU 818594 **109<sup>99</sup>**  
 24481

- Speed: 0 to 2,200 RPM and 0 to 2,900 IPM
- Nut Busting Torque: 300 Ft/Lb.
- Tightening Torque: 260 Ft/Lb.
- Weight: 8 Lb.
- Battery Light Indicators
- Charge Time: 2 Hrs.
- Includes: 4.0Ah Li-ion Rechargeable Battery with Charging Station and Sturdy Blow Mold Storage Case



20V Max\* Li-ion  
**1/2" Brushless Impact Wrench**  
 SKU 592251 **179<sup>99</sup>**  
 24486

- Variable Speed: 0 to 2,600 RPM and 0 to 3,000 IPM
- Nut Busting Torque: 300 Ft/Lb.
- Tightening Torque: 260 Ft/Lb.
- Charge Time: 2 Hrs.
- Weight: 9.28 Lb.
- Includes: Rechargeable 4.0Ah Li-ion Battery, Charging Station and Sturdy Blow Mold Storage Case



OEMTOOLS®

20V MAX\* LI-ION

BRUSHLESS MOTOR

20V Max\* Li-ion  
**1/2" Brushless Hammer Drill**  
 SKU 593469 **149<sup>99</sup>**  
 24485

- Variable Speed: 0-600 RPM and 0-2000 RPM
- Max. Torque: 310 In/Lb.
- Electric Brake
- Clutch: 21 + 1 Torque Setting
- Charge Time: 1 Hour
- Includes: Rechargeable 2.0Ah Li-ion Battery, Charging Station and Sturdy Blow Mold Storage Case



20V Max\* Li-ion  
**Cordless Angle Grinder**  
 SKU 598786 **134<sup>99</sup>**  
 24492

- Speed: 0 to 10,000 RPM
- Max. Disc Diameter: 4-1/2"
- Spindle Thread: 5/8"
- Spindle Lock: Yes
- Charge Time: 2 Hrs.
- Includes: Grinding Disc, Assist Handle, Rechargeable 4.0Ah Li-ion Rechargeable Battery and Charging Station



20V Max\* Li-ion  
**Reciprocating Saw** **SAVE \$10**  
 SKU 592353 **89<sup>99</sup>** REG. \$99.99  
 24491

- Variable Speed: 0 to 3,000 RPM
- Overall Length: 14-1/4"
- Charge Time: 1 Hour
- Includes: High-Quality, Multi-Purpose Bi-Metal Reciprocating Saw Blade, Rechargeable 2.0Ah Li-ion Battery and Charging Station



Offer Good While Supplies Last Through March 31, 2025

## All Professional OEMTOOLS 20V Power Tools Work with:

### Battery Charger

SKU 824778 **49<sup>99</sup>**  
 27333B

- Replacement Part for OEMTOOLS Heavy Duty 1/2" 2VSR Cordless 20V Li-ion Drill



### Replacement Batteries

**2.0Ah**  
 SKU 824777 **64<sup>99</sup>**  
 27333A

**4.0Ah**  
 SKU 824772 **99<sup>99</sup>**  
 27314AM



\*With respect to 20V Max, Maximum initial battery voltage (measured without a workload) is 20 volts. Nominal voltage is 18V.

## Corded OEMTOOLS®

### Oscillating Tool

SKU 592331 **54<sup>99</sup>**  
 24495

- Includes: 3-1/2" Semi-Circle Wood Saw Blade, 2" Rigid Scraper, 1-1/4" Wood Plunge Blade, Standard Sanding Pad and (3) 60/80/120 Grit Sandpapers and 6 Ft. Power Cord
- Variable Speed: 11,000 to 20,000 OPM
- Power: 2.3 Amps

- Overall Length: 14-1/2"
- Power Cord Length: 6 Ft.



OEMTOOLS®

### 7" Variable Speed Polisher

SKU 592258 **79<sup>99</sup>**  
 24496

- No-Load Speed: 1000 to 3000 RPM
- Power: 11 Amps
- Spindle Thread: 5/8"
- Spindle Lock: Yes
- Power Cord Length: 6 Ft.
- Includes: Sanding Paper, Sanding Pad, Terry Bonnet, Wool Bonnet and Foam Piece



OEMTOOLS®

### 6" Bench Grinder with Lamp

SKU 412598 **129<sup>99</sup>**  
 80058

- Solid, Heavy Duty Construction for Shaping and Sharpening Hardened Steel
- 6" Wheels with Tool Rests
- Tool Rests Adjust to 45° or 90° Position
- Includes: Coarse and Fine 6" Grinder Wheels, Goose Neck Lamp, Adjustable Eye Guards and Spark Breakers



OEMTOOLS®

### Bench Grinding Wheel

6" X 3/4" 46 Grit  
 SKU 112398 **39<sup>99</sup>**  
 SHA2017

- Economical, Long Lasting Abrasive Wheels



SHARK USA

### 14" Chop Saw

SKU 1228718 **239<sup>99</sup>**  
 24723

- Ideal for Cutting Wood, Metal, Steel and Pipe
- 15 Amp Motor for Powerful Cutting Action
- Spindle Lock Makes Wheel Changes Quick and Easy
- Accepts Standard 14" Cutoff Discs
- Includes: Cutting Blade and 6 Ft. Power Cord



OEMTOOLS®

# POWER TOOLS

## OEMTOOLS®

20V Max\* Li-ion  
**3/8" Cordless Drill**  
 SKU 052383 **67<sup>99</sup>**  
 24660

- Chuck Size: 1/2" Keyless Jacob's Chuck
- No-Load Variable 2 Speed Gear Box: 0 to 350 RPM and 0 to 1,150 RPM
- Max. Torque: 220 In/Lb.
- Max. Drilling Capacity: 5/16" (Metal) and 3/4" (Wood)
- Keyless, Auto Spindle Lock Chuck Size: 3/8"
- Clutch: 16 + 1 Torque Clutch Setting
- Electric Brake
- Forward and Reverse Switch
- Battery Charge and Capacity Indicator Lights
- Charge Time: 4 to 6 Hrs.
- Includes: 1.5Ah Li-ion Rechargeable Battery and Battery Charger



20V  
MAX  
LI-ION

20V Max\* Li-ion  
**3/8" Cordless Impact Wrench**

SKU 052379 **82<sup>99</sup>**  
 24661

- Anvil: Heat-Treated 3/8" Drive Ball Detent
- Variable Speed: 0 to 2,400 RPM and 0 to 3,000 IPM
- Max. Torque: 200 Ft/Lb. (Forward) and 240 Ft/Lb. (Reverse)
- Battery: 1.5Ah Li-ion
- Electric Brake
- Battery Charge and Capacity Indicator Lights
- Charge Time: 3 to 5 Hrs.
- Includes: 1.5Ah Li-ion Rechargeable Battery and Diagnostic Fast Battery Charger



20V  
MAX  
LI-ION

20V Max\* Li-ion  
**1/2" Cordless Impact Wrench**

SKU 052380 **99<sup>99</sup>**  
 24670

- Anvil: 1/2" Square Drive
- Speed: 0 to 2,200 RPM; 0 to 2,700 IPM
- Nut Busting Torque: 300 Ft/Lb.
- Max. Tightening Torque: 240 Ft/Lb.
- Battery: 2.0Ah Li-ion
- Weight: 6.5 Lb.
- Charge Time: 5 to 7 Hrs.
- Includes: 2.0Ah Li-ion Rechargeable Battery, Li-ion Battery Charger



20V  
MAX  
LI-ION

OEM TOOLS®

STORE STOCKED

STORE STOCKED

STORE STOCKED

Individual Batteries  
 and Charger  
 Available

20V Max\* Li-ion  
**Battery 1.5 Amps**  
 SKU 029415  
 24660A **45<sup>99</sup>**

- Charges in 4 to 6 Hrs.

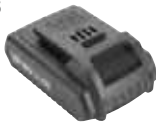

20V Max\* Li-ion  
**Battery 2.0 Amps**  
 SKU 1392334 **49<sup>99</sup>**  
 24670-36

- Charges in 4 to 6 Hrs.



20V Max\* Li-ion  
**Battery Charger**  
 SKU 029418  
 24660B **19<sup>99</sup>**



**4-1/2" Compact Angle Grinder**

SKU 052382 **43<sup>55</sup>**  
 24663

- Motor: 6 Amp
- Voltage: 120V, 60 Hz
- Speed: 10,500 RPM
- Interchangeable Handle for Left or Right Hand Use
- Heavy Duty, Cast Aluminum Gear Head for Strength and Durability
- 6 Ft. Power Cord
- Includes: Grinding Wheel, Spanner Wrench and Disc Guard



**Heavy Duty 1/2" Impact Wrench**

SKU 052388 **69<sup>99</sup>**  
 24666

- Input Power: 8.5 Amp
- Voltage: 120V, 60 Hz
- 1/2" Square Drive with Hog Ring Retainer
- No-Load Speed: 0 to 2,200 RPM and 0 to 3,000 IPM
- Replaceable Carbon Brushes
- 8 Ft. Power Cord



STORE STOCKED

STORE STOCKED

**Rotary Tool with 35 Piece Accessory Kit**

SKU 052384 **37<sup>99</sup>**  
 24664

- Input Power: 1.2 Amp
- Voltage: 120V, 60 Hz
- No-Load Speed: 10,000 to 35,000 RPM
- Collet Capacity: 1/8" to 3/32"
- Spindle Lock for Easy Bit and Accessory Change
- 6 Ft. Power Cord
- Includes: Grinding Stones, Wheels, Brush, Sanding Bands and Disc, plus Grinding, Cloth and Cut-Off Wheels



Includes 35 Piece Accessory Kit



**Flexible Shaft Rotary Tool Extension**

SKU 003483 **21<sup>99</sup>**  
 24657

- Easily Attaches to Many Popular Rotary Tools



STORE STOCKED

12V Max\*\* Li-ion  
**Power Ratchet**

SKU 1069064 **69<sup>99</sup>**  
 24685

- Max. Torque: 35 Ft./Lb.
- Max. Manual Torque: 96 Ft./Lb.
- No-Load Speed: 230 RPM
- Ergonomic Grip with Low-Profile Head for Work in Tight Spaces
- Features Integrated Worklight for Hard-to-See Spots
- Includes: 2Ah Li-ion Removable Battery and Charger



**Dual Temp Heat Gun**

SKU 052387 **29<sup>99</sup>**  
 24665

- Input Power: 10 Amp
- Voltage: 120V, 60 Hz
- Temperature Settings: 482°F/842°F
- Trigger: 3 Position Rocker
- Hanging Loop for Storage
- 6 Ft. Power Cord



STORE STOCKED

\*With respect to 20V Max, Maximum initial battery voltage (measured without a workload) is 20 volts. Nominal voltage is 18V.

\*\*With respect to 12V Max, Maximum initial battery voltage (measured without a workload) is 12 volts. Nominal voltage is 10.8V.

Prices subject to change without notice. Prices do not include applicable taxes, vehicles, tires, rims, installation or optional equipment as shown. Please do not return purchases to the store. For information regarding warranty, repair, or any questions or concerns, call 901-300-4878.

# POWER TOOLS

TO ORDER, contact your Commercial Sales Manager or go to [AutoZonePro.com](http://AutoZonePro.com)

POWER TOOLS

## Power Tool Accessories

### 33 Piece Impact Rated Driving Bit Set

SKU 750443 **14<sup>99</sup>**  
25960

- Designed to Withstand High Torque Applications
- Reduces Wear, Stripping and Cam-Out
- Includes: Magnetic Impact Rated Bit Adapter



OEM TOOLS®

S2  
STEEL

### 6 Piece Bi-Metal Hole Saw Set

SKU 547011 **19<sup>99</sup>**  
24378 REG. \$24.99

- Includes: Sizes: 7/8", 1", 1-1/8", 1-1/4" and 1-1/2" (22 mm, 25 mm, 29 mm, 32 mm and 38 mm)
- Slotted Saw Allows for Easier Plug Removal
- Durable Enamel Finish Protects Against Corrosion
- Bi-Metal Construction for Increased Wear Resistance

Offer Good Through March 31, 2025



OEM TOOLS®

SAVE \$5

### Bench Grinder, Vise and Drill Press Stand

SKU 943120 **129<sup>99</sup>**  
24643

- Heavy Duty Steel Construction Features Large Base to Prevent Walking or Wobbling During Operation and is Pre-Drilled for Mounting
- Top/Plate Dimensions: 13.8"(L) x 9.8"(W) x 0.2"(H)
- Overall Dimensions: 13.8"(L) x 9.8"(W) x 37.4"(H)



Multiple Mounting Configurations Fit Many Bench Grinders, Pipe Benders, Vises and Drill Presses

### Multi-Purpose Drill Powered Pump

SKU 526513 **24<sup>99</sup>**  
24503

- Works with a Corded or Cordless Drill to Transfer the Following Liquids: Fresh Water, Sea Water, Organic Solvents, Motor Oil, Heating Oil, Insecticides and Liquid Fertilizers



OEM TOOLS®

### 4-1/2" x 1/16" x 7/8" Cut Off Wheel Pack of 6

SKU 1485031 **19<sup>99</sup>**  
26510PK

- 4 1/2" Wheel Diameter
- 1/16" Wheel Thickness
- 7/8" Arbor Diameter
- Will Evenly Cut Through Fiberglass, Plastic and Steel
- Arbor Diameter Fits Most Drills



OEM TOOLS®

### 4.5" Depressed Center Grinding Wheels

SKU 1485045 **14<sup>99</sup>**  
SHA12734

- Type 27 Aluminum Oxide Grinding Wheels
- Arbor: 7/8"
- Diameter: 4.5 by 1/4"
- Hubless, 24 Grit
- Pack Contains 3 Wheels



SHARK USA

## Mechanics Set

SKU 533204 | 24974

**1,749<sup>99</sup>** REG. \$2,056.51

SAVE \$306

### Includes 156 of the Most Common Tools in Tool Cart

- SAE and Metric, 1/4", 3/8" and 1/2" Drive Tools, Combination Wrench Sets, Pliers and Screwdrivers. Plus Battery Service Tools, Oil Change Tools and More



Cart Style and Color May Vary

Offer Good While Supplies Last Through March 31, 2025

## Technicians Set

SKU 533203 | 24975

**2,249<sup>99</sup>** REG. \$2,791.22

OEM TOOLS®

SAVE \$541

### Includes 312 of the Most Common Tools in Tool Cart

- SAE and Metric, 1/4", 3/8" and 1/2" Drive Tools, Combination Wrench Sets, Pliers and Screwdrivers. Plus Battery Service Tools, Oil Change, Wheel Service and More



Cart Style and Color May Vary

Offer Good While Supplies Last Through March 31, 2025

Prices subject to change without notice. Prices do not include applicable taxes, vehicles, tires, rims, installation or optional equipment as shown. Please do not return purchases to the store. For information regarding warranty, repair, or any questions or concerns, call 901-300-4878.

AZG0125

79

# JACKS & HYDRAULICS

## Floor Jacks

### 3 Ton Long/Low Signature Service Jack

SKU 1407611 **279<sup>99</sup>**  
24868

- Extra Long and Low Profile is Great for Low Clearance Vehicles, Pickups and SUVs
- Padded Jack Handle and Saddle Pad to Prevent Vehicle Damage
- Dual Pump Design for Quicker Lifting
- Nylon Casters to Protect Sealed Floor Surfaces and Dealer Showrooms
- Min. Height: 3-3/8"
- Max. Height: 24-1/4"
- Length: 31-3/8"
- Weight: 100.3 Lb.



3 3/8" **LOW PROFILE**

**LONG REACH**

**PADDED HANDLE**

**OEM TOOLS®**

### 2-1/2 Ton Aluminum/Steel Hybrid Floor Jack

SKU 1417557 **199<sup>99</sup>**  
24869

- Aluminum and Steel Frame Construction Provides the Benefit of Strength Along with Light Weight
- Padded Jack Handle and Saddle Pad to Prevent Damage to Vehicle
- Dual Pump Design for Quicker Lifting
- Nylon Casters to Protect Sealed Floor Surfaces and Dealer Showrooms
- Min. Height: 3-1/2"
- Max. Height: 19-1/4"
- Length: 25-1/2"
- Weight: 58.2 Lb.



3 1/2" **LOW PROFILE**

**PADDED HANDLE**



Dual Pump Design for Quicker Lifting



Min. Height: 3-3/8"  
Max. Height: 24-1/4"  
Length: 31-3/8"

Long Reach Low Profile



Nylon Casters Protect Floor Surfaces



Dual Pump Design for Quicker Lifting



Max. Height: 19-1/4"  
Min. Height: 3-1/2"

Low Profile



Nylon Casters Protect Floor Surfaces

**BUY ANY FLOOR JACK BELOW - GET THESE**

**BONUS VALUE: \$99.99**

**6 Ton Jack Stands (Pair)**  
24853

With Purchase of: 24791, 24837 or 24838



Offer Good While Supplies Last Through March 31, 2025



### 2-1/2 Ton Low Profile Floor Jack

SKU 1089029 **199<sup>99</sup>**  
24791

- Dual Pump Pistons for a Quick Lift Design
- Min. Height: 3-1/8"
- Max. Height: 19-3/4"
- Length: 26-1/4"
- Weight: 69.5 Lb.



3 1/8" **LOW PROFILE**

**PADDED HANDLE**

Min. Height: 3-1/8"

Max. Height: 19-3/4"

### 3-1/2 Ton Low Profile Floor Jack

SKU 757109  
24837

**219<sup>99</sup>**

- Dual Pump Design for Quicker Lifting
- Min. Height: 3-3/4"
- Max. Height: 20-1/2"
- Length: 27-1/8"
- Weight: 85.8 Lb.



3 3/4" **LOW PROFILE**

**PADDED HANDLE**

Max. Height: 20-1/2"

Min. Height: 3-3/4"



### 2 Ton Extra Long, Extra Low Profile Floor Jack

SKU 757041 **299<sup>99</sup>**  
24838

- Min. Height: 2-3/4"
- Max. Height: 24"
- Length: 31-7/8"
- Weight: 97.5 Lb.



2 3/4" **LOW PROFILE**

**PADDED HANDLE**

**LONG REACH**

Long Reach to Get Under Lowered Vehicles to Lift Point

Length: 31-7/8"

All OEMTOOLS® Jacks on this page include overload and bypass safety valves and meet ASME PASE 2014 Safety Standards.

Prices subject to change without notice. Prices do not include applicable taxes, vehicles, tires, rims, installation or optional equipment as shown. Please do not return purchases to the store. For information regarding warranty, repair, or any questions or concerns, call 901-300-4878.



# JACKS & HYDRAULICS

TO ORDER, contact your Commercial Sales Manager or go to [AutoZonePro.com](http://AutoZonePro.com)

JACKS & HYDRAULICS

## Jack Stands

### 3 Ton Jack Stands (Pair)

SKU 757122 **59<sup>99</sup>**  
24852

- Min. Height: 11"
- Max. Height: 16-1/2"



### 6 Ton Jack Stands (Pair)

SKU 757050 **99<sup>99</sup>**  
24853

- Min. Height: 15.75"
- Max. Height: 23.7"



### 22 Ton Heavy Duty Axle Stands (Pair)

SKU 757098 **179<sup>99</sup>**  
24854

- Min. Height: 12-1/4"
- Max. Height: 19-3/4"
- Adjustable Pin Design
- Features Handle for Transport and Positioning
- Large V-Shaped Saddles Center Lift Points for Secure Placement



### 4 Ton Ratcheting Jack Stand (Pair)

SKU 1142454 **84<sup>99</sup>**  
VIK55040

- Min. Height: 14"
- Max. Height: 21"
- Width: 8.44"

### 6 Ton Ratcheting Jack Stand (Pair)

SKU OUTSIDE BUY/EPO **99<sup>99</sup>**  
VIK55060

- Min. Height: 15.75"
- Max. Height: 24.38"
- Width: 11"



For Outside Buy/EPO, Call 901-300-4878

## Air Hydraulic Jacks

### 20 Ton Air Hydraulic Bottle Jack

SKU 544795 **129<sup>99</sup>**  
24850

- Can Be Operated with Air or Manually
- Height: 10.25" to 20.1"
- Extension Screw Adjustment: 3.15"



### 22 Ton Air Hydraulic Truck Jack

SKU 544796 **379<sup>99</sup>**  
24851

- Compact, Low Profile Design Easily and Safely Fits Between Wheels of Tandem Axle Vehicles
- Ram Travel: 4-15/16"
- Extension Screw Adjustment: 4"
- Min. Height: 8-3/4"
- Max. Height: 17-11/16"



Hydraulic Jacks Built for Performance and Ease of Use

## 4 Ton Floor Jack

### 4 Ton Heavy Duty Floor Jack

SKU 954207 **479<sup>99</sup>**  
AFF400SS

- High Grade U-Cup Seals and High Pressure Plunger for Maximum Performance
- Heavy Duty Pump, Ram and Cylinders are Precision Machined and Inspected
- Universal Joint Technology
- Rear Mounted Swivel Casters
- Pinned and Padded Saddle
- Twin Hydraulic System
- Flanged Side Plates
- Meets ASME 2014 Standards



## Wheel Dollies

### Mechanical Vehicle Position Dollies

- Easily Lift and Move Vehicles Up to 6,000 Lb.
- 1,500 Lb. Capacity Each



### Set of 4 Dollies with Storage Cradle

SKU 1414391 **499<sup>99</sup>**  
69000

**499<sup>99</sup>**

REG. \$564.97

**SAVE OVER \$64**

When You Buy the Set

### Set of 2 Dollies

SKU 1089031 **249<sup>99</sup>**  
24793



### Hydraulic Vehicle Position Dollies

- Easily Lift and Move Vehicles Up to 6,000 Lb.
- 1,500 Lb. Capacity Each



### Set of 4 Dollies with Storage Cradle

SKU 696485 **599<sup>99</sup>**  
68986

**599<sup>99</sup>**

REG. \$664.97

**SAVE OVER \$64**

When You Buy the Set

### Set of 2 Dollies

SKU 298098 **299<sup>99</sup>**  
24855TWO



### Vehicle Position Dolly Cradle

SKU 544800 **64<sup>99</sup>**  
24856

- Neatly Secure and Store Up to 4 Vehicle Car Dolly Jacks



Prices subject to change without notice. Prices do not include applicable taxes, vehicles, tires, rims, installation or optional equipment as shown. Please do not return purchases to the store. For information regarding warranty, repair, or any questions or concerns, call 901-300-4878.

AZG0125

# JACKS & HYDRAULICS

## Transmission Jacks

### 1,000 Lb. Telescopic Transmission Jack

SKU 544786  
24840

**199<sup>99</sup>**

- Load Capacity: 1,000 Lb.
- Lowered Height: 51"
- Raised Height: 70"
- 2-Way Adjustable Saddle
- Heavy Duty Ram with Controlled Release Feature



### 1,100 Lb. High Lift Transmission Jack with Foot Pump

SKU 750006  
24844

**299<sup>99</sup>**

- Load Capacity: 1,100 Lb.
- Lowered Height: 47"
- Raised Height: 79"
- 4-Way Adjustable Saddle
- Spring-Loaded Release Valve Stops Lowering When You Let Go

Foot Pedal Pump and Release for Hands-Free Operation



### 1,100 Lb. 2 Stage Telescoping Transmission Jack

SKU 1089028  
24790

**499<sup>99</sup>** REG. \$699.99

- Second Stage Capacity: 1,100 Lb.
- Lowered Height: 37"
- Raised Height: 76.4"
- 4-Way Adjustable Saddle
- Fast Lifting Pump

SAVE \$200

Foot Pedal Pump and Release for Hands-Free Operation

Offer Good While Supplies Last Through March 31, 2025



### 1 Ton 2 Stage Telescoping Transmission Jack

SKU 1142678  
26842

**749<sup>99</sup>**

- Second Stage Capacity: 2,000 Lb.
- Lowered Height: 37.5"
- Raised Height: 76"
- 4-Way Adjustable Saddle
- Internal Shaft Retention to Prevent Leaks and Dirt Intrusion

Foot Pedal Pump and Release for Hands-Free Operation



### 800 Lb. Low-Profile Transmission Jack

SKU 544789  
24845

**349<sup>99</sup>**

SAVE \$80

REG. \$429.99

- Fully Adjustable Saddle Adapts to Most Transmission Pans
- Swivel Saddle Adjusts Both Directions
- Meets ANSI 2014 Standards
- Lowered Height: 8.5"
- Raised Height: 24.5"



Offer Good While Supplies Last Through March 31, 2025

### 1/2 Ton Transmission Jack

SKU OUTSIDE BUY/EPO  
RANRTJ1100

**599<sup>99</sup>**

- Lifting Capacity: 1,100 Lb.
- Lowered Height: 45"
- Raised Height: 72"

72" REACH

For Outside Buy/EPO, Call 901-300-4878



### 1 Ton Telescoping Transjak™ Transmission Jack

SKU OUTSIDE BUY/EPO  
RANRTJ1

**949<sup>99</sup>**

- Capacity First Stage: 2,000 Lb.
- Capacity Second Stage: 1,000 Lb.
- Lowered Height: 37"
- Raised Height: 71"

71" REACH

For Outside Buy/EPO, Call 901-300-4878



### 1-1/2 Ton Telescoping Transmission Jack

SKU OUTSIDE BUY/EPO  
RANRTJ3000

**999<sup>99</sup>**

- Capacity First Stage: 3,000 Lb.
- Capacity Second Stage: 2,000 Lb.
- Lowered Height: 35-1/2"
- Raised Height: 71-1/2"

71-1/2" REACH

For Outside Buy/EPO, Call 901-300-4878



### 1,100 Lb. Manual Transmission Jack

SKU 954229  
AFF3052

**1,229<sup>99</sup>**

- 2 Stage Telescopic Ram Designed for Medium Truck Transmissions, Transfer Cases and Differentials
- Chrome Plated Pump Core and Piston Rod Reduces Friction and Provides Long Service Life
- Powder Coat Finish Provides Resistance to Corrosion, Chemicals and Scratches
- Adjustable Saddle with Corner Bracket and Safety Chain
- Double Pump Hydraulic System for Quick Lift Operation
- Adheres to ASME 2014



78" REACH

### 1,100 Lb. Air Assist Transmission Jack

SKU 954225  
AFF3052A

**1,349<sup>99</sup>**

- 2 Stage Telescopic Ram Designed for Medium Truck Transmissions, Transfer Cases and Differentials
- Chrome Plated Pump Core and Piston Rod Reduces Friction and Provides Long Service Life
- Powder Coat Finish Provides Resistance to Corrosion, Chemicals and Scratches
- Adjustable Saddle with Corner Bracket and Safety Chain
- Double Pump Hydraulic System for Quick Lift Operation
- Adheres to ASME 2014



78" REACH

## You May Also Need

### Fuel Tank Adapter

SKU 1407554  
24832

**129<sup>99</sup>**

- Makes Fuel Tank Removal Safe and Easy
- Works with Most Transmission Jacks
- Includes: 2 Nylon Straps to Secure Tank
- Foam Rubber Pads Protect Tank

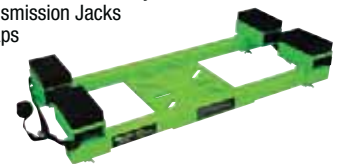

### Transmission Drain Pan

SKU 908383  
87035

**29<sup>99</sup>**

- Flexible Plastic Construction Fits on Top of Funnels for Most Lift Drains
- Built-In Screen to Catch Debris, Parts and Tools
- Dimensions: 22-3/4" (L) x 23-3/4" (W) x 4-3/4" (H)



# JACKS & HYDRAULICS

TO ORDER, contact your Commercial Sales Manager or go to [AutoZonePro.com](http://AutoZonePro.com)

JACKS & HYDRAULICS

## Engine Stands

### 1,250 Lb. Engine Stand

SKU 462493  
24829 **149<sup>99</sup>**

- Easy to Move and Rotate
- Heavy Gauge Square Steel Tube Frame
- Extra Wide 4 Wheel Base Provides Added Stability
- 360° Rotation
- Lock Pin Locks Engine into Position



### Heavy Duty 1,000 Lb. Engine Stand

SKU 757115  
24839 **119<sup>99</sup>**

- Adjustable Mounting Arms to Fit Most Engine Configurations
- Locking Head Plate with 360° Engine Rotation
- Tubular Steel Construction
- Base: 32-1/2" (L) x 30-3/4" (W)
- Height: 37-3/8"
- Weight: 41.9 Lb.



### 1,100 Lb. Rotating Engine Stand

SKU 1125862  
24798 **349<sup>99</sup>**

- Adjustable Mounting Arms to Fit Most Engine Configurations
- Locking Head Plate with 360° Engine Rotation
- Heavy Duty Worm Gear for Effortless Rotation
- Tubular Steel Construction
- Folding Legs for Easy Storage
- Base: 41-1/4" (L) x 27-1/8" (W)
- Weight: 102.5 Lb.



### 1 Ton Folding Engine Stand

SKU 544804  
24834 **229<sup>99</sup>**

- Folds Upright to Conserve Valuable Floor Space
- Sturdy, Wide-Base Design to Prevent Tipping Under Load



## Shop Cranes

### 6,000 Lb. Heavy Duty Engine Crane

SKU 1267948  
AFF3584 **1,399<sup>99</sup>**

- Reinforced Leg Assemblies for Added Strength and Durability
- 4 Different Boom Settings: 3, 2, 1.5 and 1 Ton
- Rear of Crane: 61.5" Tall x 33" Wide
- Distance Between Front of Legs: Retracted 23", Extended 28.5"
- Built-In Safety Overload to Protect the Unit from Being Used Beyond its Rated Capacity



### 2 Ton Folding Shop Crane

SKU OUTSIDE BUY/EPO  
RANRSC2TF

**629<sup>99</sup>**

- Heavy Duty Hydraulic Folding Engine Hoist with 2 Ton Capacity Ram is Perfect for Shops That Have Limited Space but Still Need the Pure Lifting Convenience of a Crane
- Front Casters Include a Safety Brake to Prevent Movement



### 2 Ton Folding Shop Crane

SKU 544801  
24830

**499<sup>99</sup>**

- Foldable Design Makes for Convenient, Easy Storage
- 6 Solid Steel Caster Wheels Add Mobility
- Fully Adjustable 4 Position Boom



For Outside Buy/EPO, Call 901-300-4878

## Lift Accessories

### Universal Engine Lift Plate 1,000 Lb. Capacity

SKU 662861  
24867 **15<sup>99</sup>**

- Corrosion Resistant, Gold Iridite Zinc Plating
- Tough, All Steel Construction
- Fits Most V Style 6 and 8 Cylinder Engines with 2 or 4 Barrel Intake Manifolds
- Mounting Hardware Not Included



### Floor Jack Crossbeam

SKU 544803  
24833 **99<sup>99</sup>**

- Compatible with Most Floor Jacks with a 1-1/8" Diameter Saddle Stud
- Saddles Adjust from 23" to 32" on Center
- Min. Width Capacity: 3,000 Lb.
- Max. Width Capacity: 4,000 Lb.



### Bed Lifter

SKU OUTSIDE BUY/EPO  
STK35885 **329<sup>99</sup>**

- Designed to Lift Truck Beds Safely and Easily
- Lifting Brackets Adjusts to Evenly Distribute Weight



Price does not include vehicle



**Ideal for Fuel Pump Replacement**

For Outside Buy/EPO, Call 901-300-4878



Prices subject to change without notice. Prices do not include applicable taxes, vehicles, tires, rims, installation or optional equipment as shown. Please do not return purchases to the store. For information regarding warranty, repair, or any questions or concerns, call 901-300-4878.

AZG0125

83

# JACKS & HYDRAULICS

## Engine Support

### 3 Point Engine Support Bar

SKU 133617 **99<sup>99</sup>**  
24951

- Makes Removal of Transaxle Easy by Supporting Engine of Front Wheel Drive Vehicles
- Width Expands from 34-1/2" to 61"
- (2) 38" Braided Steel Cables
- 700 Lb. Capacity



### 1,100 Lb. Engine Support

SKU 512946 **149<sup>99</sup>**  
24950

- 2 Screw Adjusters for Precise Positioning Makes Job Easier, Faster and Safer
- Rubber Feet to Prevent Damage to Vehicle and Ensure Stability
- 1,100 Lb. Capacity



### Engine Transverse Bar with Support Arm

SKU 662856 **129<sup>99</sup>**  
AST5820

- Makes Removal of Transaxle Easy by Supporting Engine of Front Wheel Drive Vehicles
- Support Arm Provides Three-Point Support for Off-Center Loads
- Includes: 1/8" Braided STEEL Cables and 14" Adjustable Hooks
- Capacity: 700 Lb.
- Weight: 21 Lb.



### 3/4 Ton Engine Leveler

SKU 544802 **49<sup>99</sup>**  
24831

- 4 Point Mounting System Provides Maximum Control
- 3 Chain Positions to Accommodate Different Engine Configurations
- Durable Steel Construction
- Smooth Operating Worm Drive Shaft for Easy Level Adjustment
- Rated Capacity: 1,500 Lb.



## High Reach Stands

### 1,500 Lb. High Reach Jack Stand

SKU 757043  
24848

**119<sup>99</sup>**

- Min. Height: 55"
- Max. Height: 78"



### 1,500 Lb. High Reach Jack Stand with Foot Pedal

SKU 757078  
24847

**149<sup>99</sup>**

- Foot Pedal Pump Saves Time Adjusting Load
- Min. Height: 55"
- Max. Height: 78"



### 2 Ton Underhoist Tripod Jack Stand

SKU 757084  
24849

**179<sup>99</sup>**

- Adjustment Pin Securely Supports Load in 5 Positions
- Min. Height: 49"
- Max. Height: 80"



### 1,650 Lb. Foot Operated High Reach Jack Stand

SKU OUTSIDE BUY/EPO  
RANRJS1TF

**199<sup>99</sup>**

- Base Dimensions: 12"
- Min. Height: 54-1/2"
- Max. Height: 80-1/2"



### 2 Ton High Tripod Jack Stand

SKU OUTSIDE BUY/EPO  
RANRJS2TH

**199<sup>99</sup>**

- Perfect for Holding Drive Train or Exhaust Components in Position
- Min. Height: 55"
- Max. Height: 87"



## Powertrain Lifts

### EV Lift Table

SKU OUTSIDE BUY/EPO  
CHLBT3300

**10,949<sup>99</sup>**

- 3,300 Lb. Lift Capacity
- Scissor-Style Lifting
- Hydraulic Cylinder and 115V Plug
- Pendant Controlled Operation
- Max. Reachable Height: 76.5"
- Complies with ASME PASE-2019
- 8" Clearance Under Base Plate for Battery Removal
- Extending, Adjusting and Tilting Top Plate for Larger Batteries



### 2,200 Lb. Lifting Table, Air/Hydraulic with Adapters

SKU OUTSIDE BUY/EPO  
CEA-MS10KIT

**3,999<sup>99</sup>**

- Designed for Removing/Replacing Battery Packs of Electric Vehicles as well as the Engine, Transmission, Drive Axle, Fuel Tank, Suspension and Sub-Frames of Traditional Vehicles
- Large Base Frame Ensures Better Stability and Reliability
- Max. Lift: 70-1/16"
- Min. Height: 22-7/16"
- Platform Length: 51-3/8" to 58-1/4"
- Platform Width: 33-1/8"



### 2,640 Lb. Lifting Table, Electric/Hydraulic with Adapters

SKU OUTSIDE BUY/EPO  
CEA-MS12MKIT

**6,499<sup>99</sup>**

### 2,500 Lb. Powertrain Lift

SKU OUTSIDE BUY/EPO  
AFF3182

**5,099<sup>99</sup>**

- Air Assist Foot Pump with 9' Extension Provides Hands-Free Operation
- Safety Latches at 30%, 50% and 80% of Max. Height
- 8" Diameter Swivel Casters for Easy Maneuverability
- Rear Wheels Can Be Locked to Prevent Rolling
- Table Top Height from 33" to 77"



### 4,500 Lb. BendPak EV Battery and Powertrain Lift Table

SKU OUTSIDE BUY/EPO  
BENEVS4500

**11,499<sup>99</sup>**

**NEW**

- Full-Rise Battery Powered Mobile Scissor Lift Table
- Remote Control Operation
- DC Electric Power System with Onboard Charging
- Full-Length Utility Trays



To Confirm Price, Availability and Ordering Instructions on Outside Buy/EPO, Call 901-300-4878

Ask About Special Pricing on Additional Multi-Lifts and Package Deals, Call 901-300-4878

## SAVE OVER \$2,049

### Hofmann Geoliner® 609 with 12K 4-Post Lift

SKU OUTSIDE BUY/EPO  
ALIGNCOMBO20

**30,499<sup>99</sup>**

- Provides Accurate, Real-time Measurements - Reduces Setup and Measurement Times While Generating Serious Productivity Benefits
- Ultra Low-Profile Design Allows Easy-On Approach Angle for Low Profile Vehicles
- Hydraulic Cylinder Mounted Underneath Runway
- Closed Front Design

**\*Hofmann Will Pay \$750 Towards Your Lift Install.**

(Must use Hofmann authorized installer.)

**ALIGNER INCLUDES:**  
Manufacturer's Set-Up

**INCLUDES:** 2 Rolling Jacks,  
Air Line Kit, Turn Plates and  
Rollback Kit



HOFEWA741TH3

HOFEELR728APKG	12K 4 Post Alignment Lift	\$17,399.99
HOFEWA741TH3	Geoliner® 609 Alignment System	\$14,399.99
	<b>Regular Price</b>	<b>\$31,799.98</b>
<b>ALIGNCOMBO20</b>	<b>COMBO PRICE</b>	<b>\$30,499.99</b>
	<b>SAVINGS</b>	<b>\$1,299.99</b>
	<b>\$750 TOWARDS LIFT INSTALL*</b>	<b>\$750.00</b>
	<b>TOTAL SAVINGS</b>	<b>\$2,049.99</b>



HOFEELR728APKG

Offer Good Through March 31, 2025

WARRANTY: 1 Year Parts and Labor

## SAVE OVER \$3,799

### Hofmann Geoliner 678 Complete Alignment System with 12,000 Lb. Scissor Lift

SKU OUTSIDE BUY/EPO  
ALIGNCOMBO26

**51,999<sup>99</sup>**

- Includes: Geoliner® 678 Aligner w/AC400 Clamps and VIN Reader, 12,000 Lb. Scissor Lift with (2) Rolling Jacks, Air Line Kit, Turn Plates and Rollback Kit
- Open Front Design Provides Easy Access to Alignment Service and Calibration Areas
- 24" Wide Runways Provide Easy Drive-On for Large Vehicles
- 70" Lifting Height

**\*Hofmann Will Pay \$1,500 Towards Your Lift Install.**

(Must use Hofmann authorized installer.)

**ALIGNER INCLUDES:**  
Manufacturer's Set-Up

**INCLUDES:** (2) Rolling Jacks, Air Line Kit,  
Premium Turn Plates and Rollback Kit

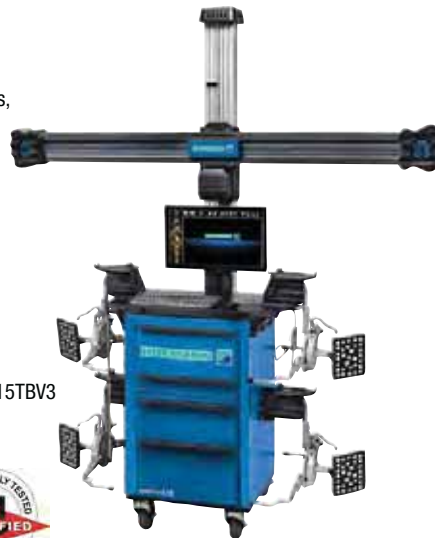

HOFA715TBV3

HOFR709APKG	12K Scissor Alignment Lift	\$26,199.99
HOFA715TBV3	GEOLINER 678 AC400 & VIN	\$28,099.99
	<b>Regular Price</b>	<b>\$54,299.98</b>
<b>ALIGNCOMBO26</b>	<b>COMBO PRICE</b>	<b>\$51,999.99</b>
	<b>SAVINGS</b>	<b>\$2,299.99</b>
	<b>\$1,500 TOWARDS LIFT INSTALL*</b>	<b>\$1,500.00</b>
	<b>TOTAL SAVINGS</b>	<b>\$3,799.99</b>



HOFR709APKG

WARRANTY: 1 Year Parts and Labor

Offer Good Through March 31, 2025



Customer Responsible For Offloading, Liftgate Service Available.

For Outside Buy/EPO, Call 901-300-4878

- Free Delivery in 48 Continental United States
- Specifications Subject to Change without Notice or Liability
- Equipment Lead Times and Shipping May Vary
- Customers Responsible for Offloading Equipment Upon Arrival
- Leasing Terms Available, Ask Your AutoZone® Commercial Sales Manager.

Prices subject to change without notice. Prices do not include applicable taxes, vehicles, tires, rims, installation or optional equipment as shown. Please do not return purchases to the store. For information regarding warranty, repair, or any questions or concerns, call 901-300-4878.

# ALIGNMENT

## Aligners



### Geoliner® 770 AC400 Clamps and VIN Reader

SKU **OUTSIDE BUY/EPO**  
HOFEWA752BV3 **30,699<sup>99</sup>**

- Lightweight, 3-Camera System Folds to a Compact Size with a Low Center of Gravity, Taking Up Less Floor Space in the Shop and Easily Maneuverable When Needed
- Touchless AC400 Wheel Clamping System (Only the Tire is Contacted), Installed in Seconds with a Single, Fast-Action Adjustment Knob
- Automatic Height Tracking to Provide Optimum Placement of its Advanced XD Targets and Cameras for More Speed and More Accuracy on Every Alignment
- Diagnostic Alignment with "Compensate Warn Alert" Intervention Gets it Right the First Time
- Video Speed Cameras Constantly Monitor Alignments, Providing Information at Every Step
- Unique Camera Beam Design Fits Through a Standard Doorway and Protects Cameras
- Next Generation UI Optimized for the High Volume User
- Highly Accurate and Reliable XD Camera Technology



**WARRANTY:**  
1 Year Motor and Parts, 6 Months Labor,  
3 Years Circuit Boards, Pods and Electronics

**ALIGNER INCLUDES:**  
Manufacturer's Set-Up



### Geoliner® 609 Alignment System

SKU **OUTSIDE BUY/EPO**  
HOFEWA741TH3

**14,399<sup>99</sup>**

- Groundbreaking User Interface Provides Instant Access to Critical Tasks
- No Calibrations Required
- Designed for a Connected World
- Small Footprint
- Includes:  
AC200 Clamps



**WARRANTY:**  
1 Year Motor and Parts,  
6 Months Labor,  
3 Years Circuit Boards,  
Pods and Electronics

**ALIGNER INCLUDES:**  
Manufacturer's Set-Up

### Geoliner® 660 Imaging Wheel Aligner

SKU **OUTSIDE BUY/EPO**  
HOFEWA712TH3 **22,499<sup>99</sup>**



- Advanced XD Cameras and Sophisticated Monitoring Algorithms
- Exclusive Dimensioning and Productivity Features
- Patented EZ-TOE – Turn the Front Wheels and Access Difficult Adjustment Points While Still Displaying Centered Toe Readings
- Features Easy-Rolling Casters, Storage for All Attachments and a Fully Enclosed Printer Compartment
- Includes AC200 Clamps, Brake Pedal Depressor, Color Ink-Jet Printer and Steering Wheel Holder



**WARRANTY:**  
1 Year Motor and Parts, 6 Months Labor,  
3 Years Circuit Boards, Pods and Electronics

**ALIGNER INCLUDES:**  
Manufacturer's Set-Up

### Geoliner® 678 Wheel Alignment System with AC400 and VIN

SKU **OUTSIDE BUY/EPO**  
HOFA715TBV3 **28,099<sup>99</sup>**



- Easy to Use Interface - 3 Levels of Intervention ("Compensate – Warn – Alert") with Corrective Actions Just One Click Away
- Help Videos - View Detailed Videos of How to Make Needed Adjustments to Complete Even the Most Complex Tasks
- Cross-Diagonal Measurements Identify Frame or Structural Damage (Saving Time)
- Rolling Radius Identifies Mismatched Tire Sizes to Prevent Vehicle Pulling and Drive Train Damage
- Touchless AC400 Wheel Clamping System (Only the Tire is Contacted), Installed in Seconds with a Single Fast-Action Adjustment Knob

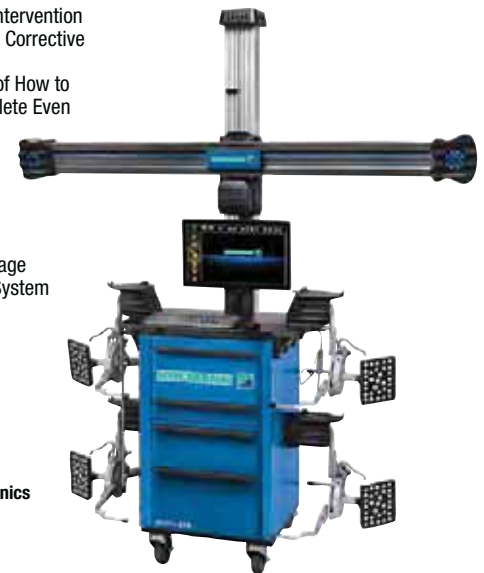

**WARRANTY:**  
1 Year Motor and Parts, 6 Months Labor,  
3 Years Circuit Boards, Pods and Electronics

**ALIGNER INCLUDES:**  
Manufacturer's Set-Up



Customer Responsible For Offloading, Liftgate Service Available.

For Outside Buy/EPO, Call 901-300-4878

- Free Delivery in 48 Continental United States
- Specifications Subject to Change without Notice or Liability
- Equipment Lead Times and Shipping May Vary
- Customers Responsible for Offloading Equipment Upon Arrival
- Leasing Terms Available, Ask Your AutoZone® Commercial Sales Manager.

## Aligners

**coats**

### CWA 6500 Wheel Aligner

SKU OUTSIDE BUY/EPO  
AMM8006500

**25,599<sup>99</sup>**

- Comes with Both Self-Centering Clamp and Exclusive Tire Gripping Adapters to Ensure Both Accurate Reading and Fast Operation
- Multiple Compensation Modes to Make Getting Readings on Heavy Vehicles Easy without Having to Roll Vehicle Excessively Far
- Two Wheel Alignment Mode for Setting Total Tow on Large Trucks, No Rear Targets Required
- Standard VIN Scanner for Time Savings and Ease of Vehicle Selection
- Mobile Cabinet Supports Aligner in Multiple Bays



**ALIGNER INCLUDES:**  
Manufacturer's Set-Up and Training

**WARRANTY:**  
1 Year Parts,  
6 Months Labor, 30 Days Wheel Clamps

### Portable 3D Wheel Alignment System

SKU OUTSIDE BUY/EPO  
ROTR1085

**22,349<sup>99</sup>**

- Mobile Tablet Operation
- Wi-Fi Ready
- Easy-to-Use Software
- Tower-Free System
- On Rack Test Drive Program
- Easy-to-Read Results
- Quick Locking Wheel Clamps
- Patented Targets
- Fixed Cameras



**ALIGNER INCLUDES:**  
Manufacturer's Set-Up

**WARRANTY:**  
3 Years Parts and  
1 Year Labor

### Complete Wheel Alignment System

SKU OUTSIDE BUY/EPO  
CMBDWA1100CWAS

**17,999<sup>99</sup>**

- Portable Wheel Stands with Integral Turn Plates on All Four Stands Align All Vehicles
- Easy to Learn, Easy to Use Software with Advanced Features and Complete Specs
- Stands Weight Limit: 10,000 Lb. or 2,500 Lb. per Stand
- Includes: Stands, Roller and Plates
- 12" to 24.5" Clamping Range
- ARGOS Inspired Software and Design
- Wi-Fi Antenna
- Ergonomic Design



### Wheel Alignment System

SKU OUTSIDE BUY/EPO  
CMBDWA1100

**15,899<sup>99</sup>**

- Alignment System Only

**ALIGNER INCLUDES:**  
Manufacturer's Set-Up and Training

**WARRANTY:**  
2 Years Parts, 1 Year Labor

**CEMB** USA  
WHEEL SERVICE EQUIPMENT

**CEMB** USA  
WHEEL SERVICE EQUIPMENT

### DWA3500 3D High Definition Wheel Alignment System

SKU OUTSIDE BUY/EPO  
CMBDWA3500

**18,999<sup>99</sup>**

**SAVE \$1,350**

REG. \$20,349.99

- 3D HD Camera Technology
- Portable Cabinet/Tower Moves Bay-to-Bay
- Adjustable Camera Height Follows Alignment Rack
- Complete 4-Wheel Alignment System
- Includes: 24" Monitor, Color Printer, Compact Wheel Targets and User-Friendly Software
- FREE 1-Year Spec Update and Shop Alignment Banner



**ALIGNER INCLUDES:**  
Manufacturer's Set-Up and Training

**WARRANTY:** 2 Years Parts, 1 Year Labor  
Offer Good Through March 31, 2025



Customer Responsible For Offloading, Liftgate Service Available.

For Outside Buy/EPO, Call 901-300-4878

## Alignment Accessories

### Steel Turn Plates

SKU OUTSIDE BUY/EPO  
QSP25-140

**Call for Price**

- Capacity: 4,500 Lb. per Plate
- Dimensions: 14" x 14" x 1.5"



### Stainless Steel Turn Plates

SKU OUTSIDE BUY/EPO  
QSP25-129

**Call for Price**



### Rear Slip Plate Add-On Kit

SKU OUTSIDE BUY/EPO  
QSPDB-6000

**Call for Price**

- (2) 59-1/2" x 20" Full Floating Rear Slip Plates
- Simple Installation On Most General Service Lifts
- Length Options: 173", 186" to 196" and 200" to 205"
- Turn Plates Not Included



### Steering Wheel Holder and Pedal Depressor Kit

SKU 802195  
24231

**64<sup>99</sup>**

- Holds Steering Wheel in Position for Alignment Adjustments
- Depresses Brake Pedal for Various Brake Checks Including Brake Lamp Operation
- Simply Hand Squeeze the Actuator to Accomplish Fine Adjustments

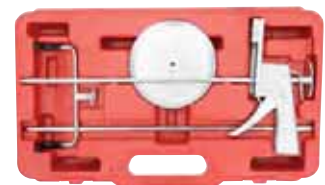

**OEM TOOLS**

• Free Delivery in 48 Continental United States • Specifications Subject to Change without Notice or Liability • Equipment Lead Times and Shipping May Vary  
• Customers Responsible for Offloading Equipment Upon Arrival • Leasing Terms Available, Ask Your AutoZone® Commercial Sales Manager.

Prices subject to change without notice. Prices do not include applicable taxes, vehicles, tires, rims, installation or optional equipment as shown. Please do not return purchases to the store. For information regarding warranty, repair, or any questions or concerns, call 901-300-4878.

# ALIGNMENT

## Alignment Lifts

### 12,000 Lb. Scissor Alignment Lift

SKU OUTSIDE BUY/EPO  
HOFR709APKG

**26,199<sup>99</sup>**

- Open Front Design Provides Easy Access to Alignment Service and Calibration Areas
- 24" Wide Runways Provide Easy Drive-On for Large Vehicles
- Dual Engaging Twin Interlocking Mechanical Safety Racks with Pneumatic Release
- 95 Second Lifting Time and 45 Second Lowering Time
- 70" Lifting Height



**HOFMANN**

**INCLUDES:** Rolling Bridge Jacks, Air Line Kit and Turn Plates

**WARRANTY:**  
1 Year Parts and Labor



### 14,000 Lb. 4 Post Alignment Lift

SKU OUTSIDE BUY/EPO  
FORCRA14

**21,499<sup>99</sup>**

- Max. Rise: 80-3/4"
- Max. Wheelbase: 182-1/2"
- 4 Wheel Alignment from 88" to 157"
- Long Lasting, High Performance Cable and Sheave System



**FORWARDLIFT**  
BY ROTARY

**INCLUDES:** Rear Slip Plates, (2) 7,000 Lb. Rolling Jacks, Radius Gauges and Internal Air Line

**WARRANTY:**  
1 Year Parts and Labor



### 15,000 Lb. 4 Post Open Front Alignment Rack Package - Ext. Length

SKU OUTSIDE BUY/EPO  
CHLAR4115XAO

**29,649<sup>99</sup>**

- Max. Wheelbase: 210"
- Improved 4-Wheel Alignment Wheelbase with Longer Rear Slip Plates
- Removable Lock without Dropping the Column
- Enclosed Column with No Outside Lubrication
- Improved Column and Cross Beam Design
- Increased Drive Through Clearance
- 26" Wide Runways
- 78" Rise Height



**CL Challenger Lifts**

**WARRANTY:**  
2 Year Parts, 1 Year Labor

**INCLUDES:** Air Line Kit, Slip Plates, Turn Plates and Two Rolling Jacks



### 4 Post Alignment Lift Combo

SKU OUTSIDE BUY/EPO  
BEN14LSXCOMB1

**15,399<sup>99</sup>**

- 14,000 Lb. Capacity
- Overall Length: 241"
- Runway Width: 20"



**BendPak**

**WARRANTY:**  
1 Year Parts and Labor

**INCLUDES:** Air Line Kit, Slip Plates, Turn Plates and Two Rolling Jacks



### 14,000 Lb. Scissor Alignment Lift Package

SKU OUTSIDE BUY/EPO  
AMM8KSC14KITP

**42,999<sup>99</sup>**

- Max. Service Wheelbase: 198"
- Max. 4 Wheel Alignment Wheelbase: 160"
- Max. 2 Wheel Alignment Wheelbase: 178"
- Ceiling Height Required: 12'
- Overall Length: 260"
- Overall Width: 91-1/2"
- Lifting Height: 74"



**coats**

**INCLUDES:** 2 HD Rolling Jacks, 2 SS Turn Plates, 2 Roll Back Bars and 1 Airline Kit

**WARRANTY:**  
1 Year Parts and 6 Months Labor



### 15,000 Lb. 4 Post Open Front Ext. Alignment Lift Pkg

SKU OUTSIDE BUY/EPO  
AMM8K4P15XKITP

**37,549<sup>99</sup>**

- Max. 4 Wheel Alignment Wheelbase: 164-1/2"
- Max. 2 Wheel Alignment Wheelbase: 209"
- Ceiling Height Required: 12' Raised Height: 75"
- Overall Length: 287-1/2"
- Overall Width: Front 143" to Rear 137-1/2"



**coats**

**INCLUDES:** 2 HD Rolling Jacks, 2 SS Turn Plates, 2 Roll Back Bars and 1 Airline Kit

**WARRANTY:**  
1 Year Parts and 6 Months Labor



Customer Responsible For Offloading.

For Outside Buy/EPO, Call 901-300-4878

• Free Delivery in 48 Continental United States • Specifications Subject to Change without Notice or Liability • Equipment Lead Times and Shipping May Vary • Customers Responsible for Offloading Equipment Upon Arrival • Leasing Terms Available, Ask Your AutoZone® Commercial Sales Manager.



## Four Post Lifts

**28,999<sup>99</sup>**

### CK-14KACX-IWA

iDEAL Alignment Lift & Wheel Aligner Combo Bundle Kit

SKU: 1429041

- High Performance Commercial Alignment Lift
- Durable, High Quality Cable Lift System
- Extended Rise Height
- 'Bolt-On' Runway Alignment Kit
- 18 Locking Height Positions
- 20" Wide Runways
- Slack Cable Safety Devices
- Self-Chocking Approach Ramps W/ Nylon Rollers
- Wide Scope High Resolution 3D Industrial Grade Cameras
- .01 Degrees Alignment Accuracy
- Wireless Internet Support



Combo Bundle Kit = (1) FP14KAC-X Alignment Lift  
(2) RAJ-7K-H Bridge Jacks & (1) IWA-60-2000T-K 3D iPRO Wheel Aligner

## Two Post Lifts

**4,799<sup>99</sup>**

### IDEAL - TP10KAC-DX

10,000lbs CAPACITY  
SKU 942096

- ALI Certified
- Bi-symmetric Arms
- Overall Height: 144"
- Overall Width: 145-1/2"
- Bi-Symmetric Lift Arms
- Low Profile Swing Arm Design
- 3 Stage Front Arms
- Adjustable Height Swivel Pads
- Stackable Height Adapters



Price Does Not Include Vehicle, Installation or Optional Equipment as Shown

## Lift Tables

**5,999<sup>99</sup>**

### LT-PT2500AH-X

2,500lbs CAPACITY

SKU 1410263

- Provides Safe & Efficient Method to Remove & Install Heavy Powertrain
- Innovative, High Quality Portable Scissor Lift Design
- Full Operation Air System Hand Controls



## Storage Lifts

**4,549<sup>99</sup>**

### FP8K-DX-XLT

8,000lbs CAPACITY

SKU 426415

- Extended Lift Height & Length
- Cable Driven Lifting System
- Single Point Manual Lock Release
- Slack Cable Safety
- Steel Approach Ramps
- Adjustable Locking Positions
- Fits in Large Residential Garages



**4,399<sup>99</sup>**

### TP11KC-DX

11,000lbs CAPACITY

SKU 426140

- Direct "Pull" Cylinders
- Overall Height: 145"
- Overall Width: 145-1/2"
- 3 Stage Front Arms,
- Low Profile Arms
- Rubber Door Guards
- Spin Up Pads with stackable drop in Height Adapters



BI-SYMMETRIC™ DESIGN  
Asymmetric/Symmetric arm configuration with 180 degree front arm rotation.

**7,099<sup>99</sup>**

### LT-PT3300DC-X

3,300lbs CAPACITY

SKU 1412412

- Provides Safe & Efficient Method To Remove & Install Heavy Powertrain Component
- Innovative, High Quality Portable Scissor Lift Design
- Full Electrical Operation
- 12vdc Battery Operation W/ Integrated 110v Battery Charger



## Scissor Lifts

**4,299<sup>99</sup>**

### LR-10K-TLPAD

10,000lbs CAPACITY

SKU 1404546

- Ideal For Express Tire & Wheel Service
- Surface Mount Install Configuration
- Integrated Outer Frame & Ramps Provide Drive-On & Off Clearance For Wide Vehicles
- Latch Release Handles On Each Side Of Lift



**3,499<sup>99</sup>**

### TP9KACX

9,000lbs CAPACITY

SKU 426138

- Asymmetric Arms
- Overall Height: 143"
- Overall Width: 138"
- Spin Up Pads with stackable drop-in height adapters



## Wheel Service

### TC-950

Semi-Automatic Tire Changer

SKU 426755

- Max Wheel Diameter: 47"
- Rim Width: 3" - 15"
- Rim Diameter: 15" - 28"

**2,569<sup>99</sup>**



## Single Post

**4,899<sup>99</sup>**

### SC-2K-UTV-X

iDEAL Single Column, UTV & Mower Storage/ Service Lift  
SKU 1413367

- 2,000 lbs Capacity
- Multi-Purpose Single Column Dual Platform Lift Design
- Ideal Storage Solution for Most Small to Mid-Sized ATVs, UTVs, Golf Carts, Riding Lawnmowers & Zero Turns



Price Does Not Include Vehicle, Installation or Optional Equipment as Shown

**3,399<sup>99</sup>**

### TP9KFX

9,000lbs CAPACITY

SKU 426106

- Symmetric Arms
- Overall Height: 112"
- Overall Width: 134.5"
- Spin Up Pads with Stackable drop-in height adapters



## DON'T FORGET THESE ACCESSORIES!



**PWB-1600**  
1,600 lbs Workbench  
SKU 1284169

**569<sup>99</sup>**



**SJ-35**  
Sliding Jack  
SKU 426447

**1199<sup>99</sup>**



**8G DRAIN**  
8 Gallon Drain  
SKU 426733

**179<sup>99</sup>**

# AUTOMOTIVE LIFTS

## Coats Lifts

### 10,000 Lb. 2 Post Lift with 3 Stage 2n1 Arms

SKU OUTSIDE BUY/EPO AMM4TV21NSR1

**6,649<sup>99</sup>**

- 90" Offset 3-Stage Front and Rear Arms for Asymmetric or Symmetric Vehicle Positioning
- Includes Door Bumper Guards and Lifting Adapters
- Premium U.S. Made Power Unit
- Overall Height: 138" or 148"



WARRANTY:  
1 Year Parts, 6 Months Labor

### 12,000 Lb. 2 Post Lift with 3 Stage Symmetric Straight Arms

SKU OUTSIDE BUY/EPO AMM4T212SSR1

**10,249<sup>99</sup>**

- Includes: Door Bumper Guards and Lifting Adapters
- Overall Width: 137-1/8"
- Overall Height: 158-7/8" or 154-7/8"
- Color: Red



### 12,000 Lb. 2 Post Lift with 3 Stage 2n1 Arms

SKU OUTSIDE BUY/EPO AMM4T212NSR1

**10,249<sup>99</sup>**

WARRANTY: 1 Year Parts, 6 Months Labor

coats



**BEFORE PLACING YOUR AUTOMOTIVE LIFT ORDER:**

Please verify minimum ceiling height, concrete requirements and bay size. See page 2 for delivery information or **Call 901-300-4878.**

## Challenger Lifts

### 10,000 Lb. 2 Post New Offset Arm Design Lift

SKU OUTSIDE BUY/EPO CHLVLE10

**Versymmetric 3-Stage Offset Front Arms**

- Lifts Versymmetric
- Rubber Door Guards
- Color: Red or Blue



**5,244<sup>99</sup>**

Versymmetric<sup>®</sup> Technology



INCLUDES: Telescoping Footpads

WARRANTY:  
1 Year Parts and Labor

### 10,000 Lb. 2-Post Versymmetric<sup>®</sup> Adjustable Lift

SKU OUTSIDE BUY/EPO CHLCL10AV3

**Versymmetric 3-Stage Front, 3-Stage Rear Arms with Swept Arm Design**

- 3 Adjustable Widths and 2 Adjustable Heights
- Can Be Set Up to Lift Most EVs
- Arm Reach: Front - Min. 20", Max. 42"
- Rear - Min. 37-5/8", Max. 60"
- Height: 12' Minimum
- Width: 14' Recommended
- Power: 208-230V, 1pH, 30 Amps

Versymmetric<sup>®</sup> Technology

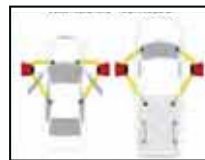

INCLUDES: Telescoping Footpads

CL Challenger Lifts

**7,264<sup>99</sup>**

**NEW**



WARRANTY:  
2 Years Parts and 1 Year Labor

## Quality Lifts

quality lifts

### 10,000 Lb. 2 Post Lift

SKU OUTSIDE BUY/EPO CHLEQ10

- 3-Stage Front, 2-Stage Rear Arms
- Lifts Symmetrically or Asymmetrically
- Ceiling Height Required: 12'
- Rubber Door Guards
- Color: Black Only



**4,814<sup>99</sup>**

INCLUDES: (4) 3" Stack Adapters

WARRANTY:  
6 Months Parts and Labor

## UPGRADE YOUR QUALITY LIFT

### Double Telescoping Foot Pads (4 Pack)

SKU OUTSIDE BUY/EPO CHLB2270PK4

- 10,000 Lb. Footpads
- Fits Quality 10,000 Lb. 2 Post Lifts
- Single Pad Features Frame Engaging Ears



### (2) 6" Stack Adapters

SKU OUTSIDE BUY/EPO CHL10313

- Upgrade for CHLEQ10 Lift

**169<sup>99</sup>**



### 12,000 Lb. 2 Post Heavy Duty Lift Screw-Style Footpad

SKU OUTSIDE BUY/EPO CHLB12162S-12

- Fits Challenger and Quality 12,000 Lb. Heavy Duty 2 Post Lifts
- Single Pad Features Frame Engaging Ears

**99<sup>99</sup>**



### 14,000 Lb. 4 Post Lift

SKU OUTSIDE BUY/EPO CHL4P14EFX

**8,769<sup>99</sup>**

- 20" Wide Runways
- 182.5" Wheelbase
- Minimum Bay Size: 12' x 24'
- Rise Height: 78"



### Air Line Kit

SKU OUTSIDE BUY/EPO CHL40230E

**634<sup>99</sup>**

WARRANTY:  
1 Year Parts and Labor  
Rolling Jacks Sold Separately

### 7,500 Lb. Rolling Jack

SKU OUTSIDE BUY/EPO CHLRJ75

**2,919<sup>99</sup>**



Optional Equipment

WORKS WITH



Customer Responsible For Offloading.

For Outside Buy/EPO, Call 901-300-4878

- Free Delivery in 48 Continental United States
- Specifications Subject to Change without Notice or Liability
- Equipment Lead Times and Shipping May Vary
- Customers Responsible for Offloading Equipment Upon Arrival
- Leasing Terms Available, Ask Your AutoZone<sup>®</sup> Commercial Sales Manager.

# AUTOMOTIVE LIFTS

FOR HELP with Selection, Confirm Availability and Ordering Instructions, Call 901-300-4878

AUTOMOTIVE LIFTS

## Forward Lifts

### 10,000 Lb. I10 2 Post Lift

SKU OUTSIDE BUY/EPO FORI10

**5,749<sup>99</sup>**

- Smooth Lifting and Long Life with Forward's Direct Pull Cylinders
- Spot-Rite™ 3-Stage Front Arms
- 76-1/4" Rise
- Low Profile Oversized Pad with 3.5" and 5" Extensions

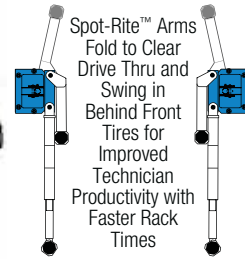

Spot-Rite™ Arms Fold to Clear Drive Thru and Swing in Behind Front Tires for Improved Technician Productivity with Faster Rack Times



**INCLUDES:**  
Truck Adapters

**WARRANTY:**  
1 Year Parts and Labor

### 12,000 Lb. I12 2 Post Lift

SKU OUTSIDE BUY/EPO FORI12N300BL

**10,749<sup>99</sup>**

- 4 Robust 3-Stage Arms with Reach Range from 27-3/4" to 59"
- Includes: 1-3/4", 3-1/2" and 5" Adapter Extenders
- Low Profile 4-3/4" Adapter
- Min. Ceiling Height: 167"
- 77-1/2" Rise



Height Configurations of 11'-10", 12'-10" and 14'-10" are Available at No Extra Charge

**3-Stage Front and Rear Arms**



**INCLUDES:**  
Truck Adapters

**WARRANTY:**  
1 Year Parts and Labor

### 15,000 Lb. DP15N001BL 2 Post Lift - Blue

SKU OUTSIDE BUY/EPO FORDP15N001BL

**15,049<sup>99</sup>**

- 175" Tall
- Single Point Lock Release Design
- Direct Pull Lifting - Smooth Operating, Low Maintenance Technology



**INCLUDES:**  
Truck Adapters

**WARRANTY:**  
1 Year Parts and Labor

### 14,000 Lb. CR14L 4 Post Lift

SKU OUTSIDE BUY/EPO FORCR14L

**9,799<sup>99</sup>**

- Heavy Duty Hydraulic Cylinder
- Single Point Latch Release System
- 78-3/4" Rise
- 18 Lock Positions
- Accommodates 182-1/2" Wheelbase Vehicles
- High Performance Cable and Sheave System



Rolling Jacks Sold Separately

**WARRANTY:**  
1 Year Parts and Labor

### Internal Air Line Kit

SKU OUTSIDE BUY/EPO ROTFC5760-14

**749<sup>99</sup>**

## WORKS WITH

### 7,000 Lb. Rolling Jack

SKU OUTSIDE BUY/EPO FORRRJ70G

**3,899<sup>99</sup>**

Optional Equipment



### Two 7,000 Lb. Rolling Jacks

SKU OUTSIDE BUY/EPO FORRRJ70GB0G

**5,849<sup>99</sup>**

Optional Equipment



Offer Valid Only with Purchase of Forward 4 Post Lift

## Rotary Lifts

### 10,000 Lb. 2-Post Asymmetric Lift with AV Arms - Blue

SKU OUTSIDE BUY/EPO ROTSPA010AVBL

**8,599<sup>99</sup>**

- Easy Spotting and Positioning
- Highest Capacity Low-Profile Lift Available
- Comes Standard with Adjustable Round, Truck and Stackable Adapter Extensions
- Overall Width: 11' 5-1/2"
- Overall Height: 11' 11-1/2"
- Arm Reach: Front: Min. 18-1/2" - Max. 41", Rear: Min. 27-5/8" - Max. 58-1/4"
- Max Rise: 81-1/2"
- Drive-Thru Clearance: 95-1/4"
- Min. Bay Size: 12' x 24'



**WARRANTY:** 1 Year Parts and Labor

Shown with Additional Accessories

### 12,000 Lb. 2 Post Lift

SKU OUTSIDE BUY/EPO ROTSP012

**12,199<sup>99</sup>**

- 3 Stage Front and Rear Arms
- Thread Up Truck Adapters and Stackable Extensions - (4) 3.5" and (4) 5"
- Accommodates Trucks and Most Cars



**WARRANTY:**  
1 Year Parts and Labor

Shown with Additional Accessories

### 14,000 Lb. 4 Post Lift

SKU OUTSIDE BUY/EPO ROTSM14L

**11,099<sup>99</sup>**

- Filter/Regulator/Lubricator Included to Extend the Life of Lift and Tools
- Max. Wheel Base: 182"
- 78" Rise
- Long Lasting Cables and Sheaves



Rolling Jacks Sold Separately

### Internal Air Line Kit

SKU OUTSIDE BUY/EPO ROTFC5760-14

**749<sup>99</sup>**

**WARRANTY:**  
1 Year Parts and Labor

## WORKS WITH

### 7,000 Lb. Rolling Jack

SKU OUTSIDE BUY/EPO ROTRJ700

**5,149<sup>99</sup>**

Optional Equipment



Customer Responsible For Offloading.

For Outside Buy/EPO, Call 901-300-4878

- Free Delivery in 48 Continental United States
- Specifications Subject to Change without Notice or Liability
- Equipment Lead Times and Shipping May Vary
- Customers Responsible for Offloading Equipment Upon Arrival
- Leasing Terms Available, Ask Your AutoZone® Commercial Sales Manager.

Prices subject to change without notice. Prices do not include applicable taxes, vehicles, tires, rims, installation or optional equipment as shown. Please do not return purchases to the store. For information regarding warranty, repair, or any questions or concerns, call 901-300-4878.

AZG0125

# AUTOMOTIVE LIFTS

## BendPak® Lifts

### 10,000 Lb. 2 Post Lifts

- Bi-Metric™ Reversible Triple Telescoping Swing Arms
- Low-Pro™ Swing Arms

- Automatic Arm Restraints
- Expandable Top Beam Accommodates Wide or Narrow Drive-Thru Configurations

**BendPak®**

SKU **OUTSIDE BUY/EPO**  
**BEN10AP**

**5,999<sup>99</sup>**

- 145" Height, 135" to 145" Width, 69" Rise



SKU **OUTSIDE BUY/EPO**  
**BEN10APX**

**6,299<sup>99</sup>**

- 157" Height, 135" to 145" Width, 75.5" Rise



SKU **OUTSIDE BUY/EPO**  
**BEN10AP-168**

**6,399<sup>99</sup>**

- 168" Height, 135" to 145" Width, 69" Rise
- 24" Bolt-On Extension for Increased Vehicle Height Clearance

SKU **OUTSIDE BUY/EPO**  
**BEN10APX-181**

**6,799<sup>99</sup>**

- 181" Height, 135" to 145" Width, 75.5" Rise
- 24" Bolt-On Extension for Increased Vehicle Height Clearance

WARRANTY: 1 Year Parts and Labor

### 12,000 Lb. 2-Post BiMetric Lift

SKU **OUTSIDE BUY/EPO**  
**BEN12APX**

**11,399<sup>99</sup>**

- Adaptable Design: Symmetric or Asymmetric
- Automatic Swing Arm Restraint System
- Includes 4 Frame Cradle Pads, 4 Medium and 4 Tall Stacking Adapters



**INCLUDES:** 4 Frame Cradle Pads, 4 Medium and 4 Tall Stacking Adapters



WARRANTY:  
1 Year Parts and Labor

### 16,000 Lb. 2-Post Lift

SKU **OUTSIDE BUY/EPO**  
**BEN16AP**

**22,399<sup>99</sup>**

- Telescoping Arms Accommodate a Wide Variety of Vehicle Chassis
- Dual Direct-Drive Hydraulic Cylinders for Smoother Operation and Less Maintenance
- Includes 4 Frame Cradle Pads, 4 Medium and 4 Tall Stacking Adapters with Column-Mounted Racks



**INCLUDES:** 4 Frame Cradle Pads, 4 Medium and 4 Tall Stacking Adapters



WARRANTY:  
1 Year Parts and Labor

### 10,000 Lb. Low-Rise Lift

SKU **OUTSIDE BUY/EPO**  
**BENLR-10000**

**4,849<sup>99</sup>**

- Lifting Cap. (Front): 5,000 Lb. - (Rear): 5,000 Lb.
- Dual Voltage Motor: 115/208-230 VAC/ 50/60 Hz/1 Ph
- Lowered Height: 4"

- Lift Height: 15" to 22.75"
- Lift Height + Blocks: 31.5" Overall
- Length: 82.65"
- Overall Width: 85"



15" to 22-3/4"

WARRANTY:  
1 Year Parts and Labor

### 6,000 Lb. Low-Rise Pad Lift

SKU **OUTSIDE BUY/EPO**  
**BENLR-60**

**2,719<sup>99</sup>**

- Max. Height: 23"
- Overall Width: 70"
- Overall Length: 82"

### Portable

SKU **OUTSIDE BUY/EPO**  
**BENLR-60P**

**2,809<sup>99</sup>**

- Max. Height: 23"
- Overall Width: 70-1/2"
- Overall Length: 82"



Lifts Up to 26" with Optional 3" Blocks

WARRANTY:  
1 Year Parts and Labor



Customer Responsible For Offloading.

For Outside Buy/EPO, Call 901-300-4878

- Free Delivery in 48 Continental United States
- Specifications Subject to Change without Notice or Liability
- Equipment Lead Times and Shipping May Vary
- Customers Responsible for Offloading Equipment Upon Arrival
- Leasing Terms Available, Ask Your AutoZone® Commercial Sales Manager.

Prices subject to change without notice. Prices do not include applicable taxes, vehicles, tires, rims, installation or optional equipment as shown. Please do not return purchases to the store. For information regarding warranty, repair, or any questions or concerns, call 901-300-4878.

# AUTOMOTIVE LIFTS

FOR HELP with Selection, Confirm Availability and Ordering Instructions, Call 901-300-4878

AUTOMOTIVE LIFTS

## BendPak® Lifts

**14,000 Lb. 4 Post Lift**  
SKU OUTSIDE BUY/EPO  
BENHDS14

**8,199<sup>99</sup>**

- Overall Width: 130"
- Overall Length: 241"
- Max. Rise: 70"
- Motor: 220 VAC/1 Ph



**14,000 Lb. Extended/Limo Style**

SKU OUTSIDE BUY/EPO  
BENHDS14X

**8,699<sup>99</sup>**

**Air Line Kit**

SKU OUTSIDE BUY/EPO  
BEN5174009

**124<sup>99</sup>**

Shown with Optional Equipment  
Rolling Jacks Sold Separately  
WARRANTY: 1 Year Parts and Labor



**9,000 Lb. 4 Post Lift**  
SKU OUTSIDE BUY/EPO  
BENHD-9

**5,649<sup>99</sup>**

- Overall Width: 110.25"
- Overall Length: 174" (2,235 mm)
- Column Height: 88" (2,235 mm)
- Max. Lifting Height: 74-1/2" (1,892 mm)



**Air Line Kit**

SKU OUTSIDE BUY/EPO  
BEN5174009

**124<sup>99</sup>**

Shown with Optional Equipment  
Rolling Jacks Sold Separately  
WARRANTY: 1 Year Parts and Labor

**WORKS WITH**

**WORKS WITH**

**7,000 Lb. Capacity Rolling Bridge Jack**  
SKU OUTSIDE BUY/EPO  
BENRJ7W

**2,179<sup>99</sup>**



Optional Equipment

**4,500 Lb. Capacity Rolling Bridge Jack**  
SKU OUTSIDE BUY/EPO  
BENRJ45W

**2,109<sup>99</sup>**



Optional Equipment

## Dannmar Lifts

**10,000 Lb. 2 Post Lift Asymmetric**

SKU OUTSIDE BUY/EPO  
DAND2-10A

**4,849<sup>99</sup>**

**SAVE \$500**

REG. \$5,349.99

- Overall Height: 145"
- Overall Width: 143.5"
- Max. Lifting Height (Top Lock): 78.5"
- Power Unit: 220 VAC/60 Hz/Single Phase

**10,000 Lb. 2 Post Lift - Symmetric**

SKU OUTSIDE BUY/EPO  
DAND2-10C

**4,799<sup>99</sup>**

**SAVE \$500**

REG. \$5,299.99

**12,000 Lb. Heavy Duty 2 Post Symmetric Lift with Triple-Telescoping Low Arms**

SKU OUTSIDE BUY/EPO  
DAND2-12C

**6,899<sup>99</sup>**

**SAVE \$1,200**

REG. \$8,099.99

WARRANTY: 1 Year Parts

Offers Good Through March 31, 2025, While Supplies Last



## Parking Lift

**7,000 Lb. High Rise - Wide Car 4 Post Lift**

SKU OUTSIDE BUY/EPO  
BENHD-7W

**5,749<sup>99</sup>**

- Max. Rise: 82"
- Overall Width: 110.25"
- Overall Length: 200.5"
- Drive-Thru Clearance: 86.5"
- Wheelbase: 70" to 115"



Shown with Optional Equipment  
WARRANTY: 1 Year Parts and Labor



Customer Responsible For Offloading.

For Outside Buy/EPO, Call 901-300-4878

- Free Delivery in 48 Continental United States
- Specifications Subject to Change without Notice or Liability
- Equipment Lead Times and Shipping May Vary
- Customers Responsible for Offloading Equipment Upon Arrival
- Leasing Terms Available, Ask Your AutoZone® Commercial Sales Manager.

Prices subject to change without notice. Prices do not include applicable taxes, vehicles, tires, rims, installation or optional equipment as shown. Please do not return purchases to the store. For information regarding warranty, repair, or any questions or concerns, call 901-300-4878.

AZG0125

93

# AUTOMOTIVE LIFTS

## Mid-Rise Lifts

**BendPak**

### 6,000 Lb. Portable Mid-Rise Lift

SKU **OUTSIDE BUY/EPO**  
**BENMD-6XP**

**3,069<sup>99</sup>**

- Portable, Easy to Move from Bay to Bay
- Adjustable Arms



**INCLUDES:**  
Truck Adapters

**Power Unit**  
Plugs into  
**110V Outlet**

**CL Challenger Lifts**

### 6,000 Lb. Capacity Mid-Rise Scissor Lift

SKU **OUTSIDE BUY/EPO**  
**CHLMR6**

**3,499<sup>99</sup>**

- 6 Safety Lock Positions
- Standard High and Low Adapters
- Sliding/Rotating Arm Design Reaches Pick-Up Points on a Wider Range of Vehicles
- Zerk Fittings on Pivot Points for Serviceability



**CL Challenger Lifts**

### 10,000 Lb. Short Rise Lift

SKU **OUTSIDE BUY/EPO**  
**CHLSRM10**

**5,499<sup>99</sup>**

- Raised Height: 22"
- Includes: (4) 2 Position Adapter Blocks



**WARRANTY:**  
1 Year Parts and Labor

## MaxJax Lift

**MAXJAX**

### MaxJax M7K

SKU **OUTSIDE BUY/EPO**  
**MJXM7K**

**4,209<sup>99</sup>**

- Lifting Height: 48"
- Clear Undercar Access
- Portability
- Stow to Go in Less Than 15 Minutes



**WARRANTY:**  
1 Year Parts and Labor

## QuickJack™ Lifts

**QUICKJACK**

### You get it all.

- Complete Package Includes: 2 Jack Frame Assemblies, (2) 150" Hydraulic Hoses, (2) 14" Aux. Hoses, 2 Quick-Mount Handles, (4) 1.5" x 3" x 4" Rubber Lifting Blocks, (4) 3" x 3" x 4" Rubber Lifting Blocks, 1 Mini Hydraulic Power Unit with Pendant Control



### 7,000 Lb. Portable Car Lift System - Extended

SKU **OUTSIDE BUY/EPO**  
**QJK7000TLX**

**2,019<sup>99</sup>**

**12V DC Options Available**

- Capacity: 7,000 Lb. (3,175 kg)
- Lowered Height: 3.5" (89 mm)
- Maximum Height: 24.5" (622 mm)
- Max. Lift Point Spread: 66" (1,676 mm)
- Min. Lift Point Spread: 43" (1,092 mm)
- Frame Length: 76" (1,930 mm)
- Frame Width: 12.5" (318 mm)
- Frame Weight: 103 Lb. (47 kg)
- Total Shipping Weight: 304 Lb. (138 kg)



### QuickJack™ SUV and Light Truck Adapters

SKU **862288**  
**RAN510561**

**234<sup>99</sup>**

- Fits BL-5000 and BL-7000 Series
- Set of 12 Pieces Includes: 4 Low Profile Round Polyurethane Contact Pads, 4 Sliding Receivers That Accommodate the Round Polyurethane Contact Pads and (4) 3" Stackable Adapters



## Motorcycle Lift

**OEM TOOLS**

### Air Hydraulic Motorcycle Lift 1,000 Lb. Capacity

SKU **662742**  
**24859**

**999<sup>99</sup>** REG. \$1,299.99

**SAVE \$300**

#### Our Lift Compares to Top Brand Motorcycle Lifts in Every Way

- 86.5" x 26.75" Platform Deck with 25.5" Long Removable Loading Ramp
- Built-In Casters and Adjustable Stabilizers
- Durable 12 Gauge, Powder Coated Diamond Plate Deck
- Air/Hydraulic Lift System Allows Use with Shop Air or as a Manual Lift
- Tie Down Rings on Deck for Added Stability



Heavy Duty, Positive Shop, Padded Wheel Vise

Rear Dropout Panel (for Rear Tire Maintenance Access)

Offer Good Through March 31, 2025



Customer Responsible For Offloading.

For Outside Buy/EPO, Call 901-300-4878







- Free Delivery in 48 Continental United States
- Specifications Subject to Change without Notice or Liability
- Equipment Lead Times and Shipping May Vary
- Customers Responsible for Offloading Equipment Upon Arrival
- Leasing Terms Available, Ask Your AutoZone® Commercial Sales Manager.

Prices subject to change without notice. Prices do not include applicable taxes, vehicles, tires, rims, installation or optional equipment as shown. Please do not return purchases to the store. For information regarding warranty, repair, or any questions or concerns, call 901-300-4878.

# AUTOMOTIVE LIFTS

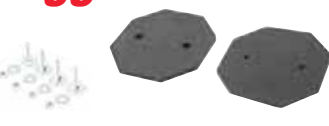
FOR HELP with Selection, Confirm Availability and Ordering Instructions, Call 901-300-4878

AUTOMOTIVE LIFTS

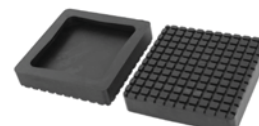
Lift Pads	Fits Models	Replaces
 <p><b>Forward/Eagle/Gemini/Worth/American Hexagon Shaped - 2 Bolt Style Lift Pads (Set of 4)</b> SKU 1137807 <b>74<sup>99</sup></b> SHA51663</p> 	I-DP9, DP09A2, DP09A, DP07A, DP97A, DP7A, Eagle and Other Texas Style 2 Post Lifts	OEM# 994105, 991234, 991222 and LP603
<p><b>Challenger Hexagon Shaped - 2 Bolt Style Lift Pads (Set of 4)</b> SKU 1137812 <b>99<sup>99</sup></b> SHA51661</p> 	20000, 21000, 26000, 27000, 28000, 30000, 31000, 33000, 36000, 37000, 39000	OEM# J0K01D, LP602
<p><b>Rubber Round Slip-on Lift Pad</b> SKU OUTSIDE BUY/EPO <b>99<sup>99</sup></b> CHLB2208</p>  <p>For Outside Buy/EPO, Call 901-300-4878</p>	Challenger CL10, E10, Q10, VS10 and Ammc0 AC21NS	N/A
<p><b>Challenger Octagon Shaped Urethane Snap-On Lift Pads (Set of 4)</b> SKU 1137804 <b>54<sup>99</sup></b> SHA51674</p> 	CL10V3, E10, LE10, VLE10, SA10, CLFP9 and EV1020	OEM# A1140HX
<p><b>Rotary Square Bolt Style Lift Pads (Set of 4)</b> SKU 1137817 <b>119<sup>99</sup></b> SHA51667</p> 	SP09, SPOA9, SPO10, SPOA10, SPO12, SI29, SL19, SL210	OEM# FJ6213, BH-7536-92P, BH7542-73 and LP609
<p><b>BendPak Square Slip-On Lift Pads (Set of 4)</b> SKU 1137805 <b>119<sup>99</sup></b> SHA51666</p> 	MX10AC, MXACX, X10CX, MX10C, XPR-9S, XPR-9S-LP, XPR-9DS, XPR-10S, XPR-10S-LP, XPR-10S-168, XPR-10AS, XPR-10AS-LP, XPR-10AS-168, XPR-12FDL, XPR-12CL, XPR-15CL, XPR-18CL, XPR-12CL-192, XPR-15CL-192, XPR-18CL-192, RJ6, RJ6000, RJ4500	OEM# 5715-365 and LP608

Challenger	CL Challenger Lifts
<p><b>Electric Vehicle Footpad</b> SKU OUTSIDE BUY/EPO <b>674<sup>99</sup></b> CHLTFFK</p> <ul style="list-style-type: none"> <li>Sold in Set of 4</li> <li>Designed Specifically to Work on Electric Vehicles</li> <li>Fits most Challenger 2-Post Lifts</li> <li>For Use with All 10K, 12K, and 16K 2-Post Lifts</li> <li>For Use with EV1020, EV1220, EV1220 and EW1220 In-Ground Lifts</li> </ul> 	
<p><b>Truck Adapter Set for 10,000 Lb. and 12,000 Lb. 2 Post Lifts</b> SKU OUTSIDE BUY/EPO <b>489<sup>99</sup></b> CHL10315</p> <ul style="list-style-type: none"> <li>Stack Adapter Extension Kit Includes:                     <ul style="list-style-type: none"> <li>(4) 3" Stack Extensions,</li> <li>(2) 6" Stack Extensions and</li> <li>2 Organizer Racks with Hardware</li> </ul> </li> </ul> 	
<p><b>GM Wide Frame Footpads (Pair)</b> SKU OUTSIDE BUY/EPO <b>524<sup>99</sup></b> CHLB2280PR</p> <ul style="list-style-type: none"> <li>Fits 2008 and Up Challenger Lifts CL10V3, E10, LE10, VLE10, SA10, CLFP9, E12, CL12 and EV1020 Models</li> <li>Works on 2019 GMC Sierra and Chevrolet Silverado Trucks</li> <li>Drop-In Design Makes Switching Simple and Quick</li> <li>Telescoping Feature Provides Simple Access to Lift Points</li> </ul>  <p>For Outside Buy/EPO, Call 901-300-4878</p>	

BendPak	BendPak
<p><b>Rubber 2 Post Lift Pad/Slip Over (Set of 4)</b> SKU 954179 <b>89<sup>99</sup></b> BEN5700227</p> <ul style="list-style-type: none"> <li>Heat and Cold Resistant</li> <li>Highly Resistant to Gouging</li> <li>Oil and Solvent Resistant</li> <li>Tear Resistant</li> </ul> 	<p><b>Lift Pad Assembly/ 35 mm Pin (Set of 4)</b> SKU 1053947 <b>189<sup>99</sup></b> BEN5215753</p> <ul style="list-style-type: none"> <li>Works with Any BendPak 2 Post Lift</li> <li>Thick Rubber Construction</li> <li>Textured Surface for Extra Grab</li> <li>Will Not Scratch the Vehicle</li> <li>Easy Drop-In Design</li> <li>5" Diameter for Enhanced Stability</li> </ul> 

<p><b>Cradle Pads</b></p> <ul style="list-style-type: none"> <li>Tactile Rubber Pad Reduces Slippage and Protects the Finish</li> <li>Made for Heavy Duty Commercial-Grade Trucks</li> <li>Installs Easily to BendPak 2 Post Lift Arms</li> <li>Sturdy Steel Construction</li> </ul>	<p><b>Frame Cradle Pads 35 mm Pin (Set of 4)</b> SKU 954221 <b>199<sup>99</sup></b> BEN5215754</p> 	<p><b>Wide Frame Cradle Pads 60 mm (Set of 2)</b> SKU 979067 <b>214<sup>99</sup></b> BEN5215848</p> 
--	--	---

• Free Delivery in 48 Continental United States • Specifications Subject to Change without Notice or Liability • Equipment Lead Times and Shipping May Vary • Customers Responsible for Offloading Equipment Upon Arrival • Leasing Terms Available, Ask Your AutoZone® Commercial Sales Manager.

Prices subject to change without notice. Prices do not include applicable taxes, vehicles, tires, rims, installation or optional equipment as shown. Please do not return purchases to the store. For information regarding warranty, repair, or any questions or concerns, call 901-300-4878.

AZG0125

# BendPak®

BendPak's **Pro-Series** offers the ultimate shop upgrade, featuring a 10AP Series lift, adapter package, and air-electric workstation. These units are built for professionals, designed to meet the needs of today's high-volume service centers.

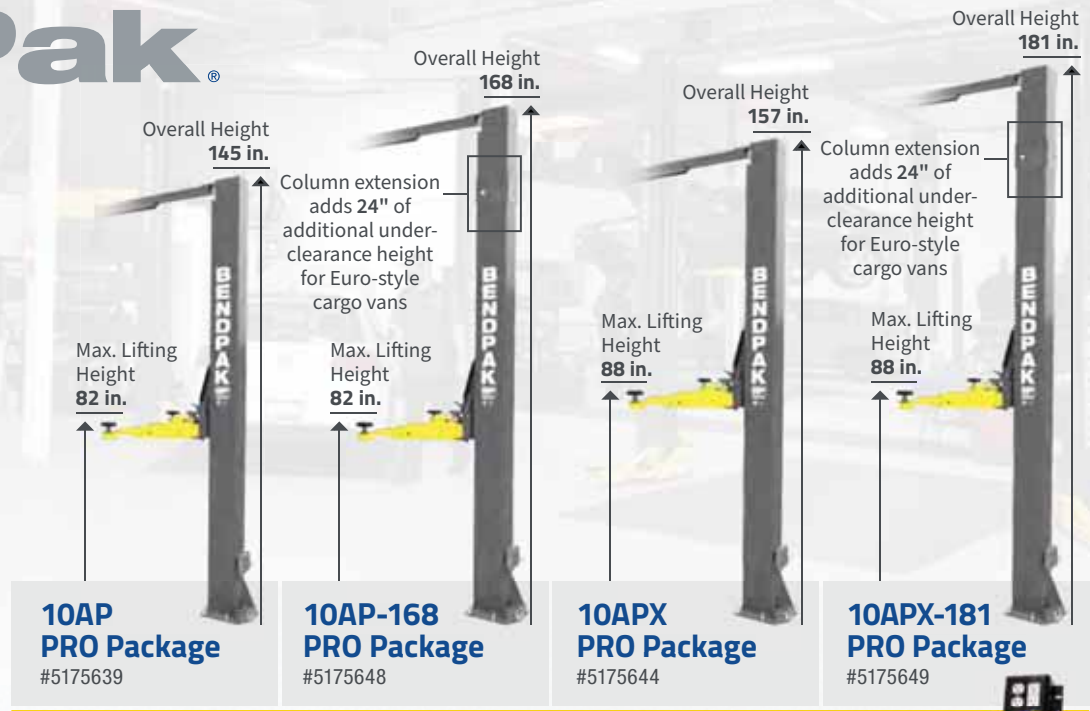

**PRO Packages Include:**

- Medium Adapters
- Tall Adapters
- Frame Cradle Pads
- Air-Electric Workstation

# Ranger® SELECT™

Now available from Ranger, **Ranger Select** provides the same commercial-grade wheel service equipment with *included* set up and training. Expert technicians ensure precise installation, calibration, and testing for optimal performance. With a focus on efficiency and durability, we minimize downtime and keep your equipment running at its best.



\*FREE SHIPPING to direct shipping points within the 48 contiguous United States only.

**BendPak®**

Prices subject to change without notice. Prices do not include applicable taxes, vehicles, tires, rims, installation or optional equipment as shown. Please do not return purchases to the store. For information regarding warranty, repair, or any questions or concerns, call 901-300-4878.



# TIRE SERVICE

FOR HELP with Selection, Confirm Availability and Ordering Instructions, Call 901-300-4878

TIRE SERVICE

## Coats Combos

### RC-45E and 885 Tire Service Combo

SKU OUTSIDE BUY/EPO AMMCOMB05

- External Rim Clamping Range from 6" to 24" (Max. Tire Diameter 50"; Max. Rim Width 10.5")
- Tire Changer Allows Inflation from 0 to 60 psi with a Built-In Pressure Limiter
- RC-45E Drive System: 1 HP Electric Motor
- 885 Balancer - Automatic Distance and Diameter Entry
- Direct Tape-A-Weight® Placement
- Auto Start Hood
- 110V



AMM800885



AMM8560994901

AMM8560994901	\$5,649.99
AMM800885	\$4,499.99
Regular Price	<b>\$10,149.98</b>
<b>COMBO PRICE</b>	<b>\$9,899.99</b>
<b>SAVINGS</b>	<b>\$249.99</b>

### RC-55E and 1300 Series Tire Service Combo

SKU OUTSIDE BUY/EPO AMMCOMB02

- RC-55E Features an External Clamping Range from 6" to 24" (Max. Tire Diameter 50"; Max. Rim Width 10-1/2")
- RC-55E Drive System: 1 HP Electric Motor
- Tire Changer Allows Inflation from 0 to 60 psi with a Built-In Pressure Limiter
- 1300 Series Wheel Balancer is Powered by Direct Drive
- Static-On-Screen® Display Identifies Any Excess Residual Static Imbalance
- Wheel Balancer Automatically Enters 2-D Data for Wheel Diameter and Offset Measurement



AMM80013002D

AMM8560995001	\$7,699.99
AMM80013002D	\$5,949.99
Regular Price	<b>\$13,649.98</b>
<b>COMBO PRICE</b>	<b>\$13,299.99</b>
<b>SAVINGS</b>	<b>\$349.99</b>



AMM8560995001

## DON'T FORGET THESE ACCESSORIES

- Works with Coats Wheel Balancers Listed on This Page



Adjustable Pin Plate Set **2,049.99**

SKU OUTSIDE BUY/EPO | AMM85610104



40 mm Light Truck Cone **449.99**

SKU OUTSIDE BUY/EPO | AMM8113277C

Customize Your Own Combo, Call for Special Pricing **901-300-4878**

## Rotary Combo

### R146P and R155 Tire Service Combo

SKU OUTSIDE BUY/EPO ROTCOMB04

- Includes: R146P Tire Changer and R155 Balancer High Quality Swing Arm Changer and Pro 3D Wheel Balancer at an Economical Price
- Changer Offers 26" Outside and 28.5" Inside Clamping with Tire Diameters Up to 46"
- PLUS91SA Helper Arm Not Installed Prior to Delivery
- Balancer Features Automatic Program, Linked Keyboard, Internal Data Gauge, and Simple Visual Display

#### R146P

- Inside Clamping: 12 to 28.5"
- Outside Clamping: 10 to 26"
- 115V, Single Phase

#### R155

- Rim Diameter: 10" to 30"
- Rim Width: 1.5" to 22"
- 115V, Single Phase
- 8 Piece Collet Kit Included



ROTR146P

ROTR155

ROTR146P	\$8,549.99
ROTR155	\$7,999.99
Regular Price	<b>\$16,549.98</b>
<b>COMBO PRICE</b>	<b>\$15,649.99</b>
<b>SAVINGS</b>	<b>\$899.99</b>

**INCLUDES: Setup and Training**

WARRANTY: 3 Years Parts and 1 Year Labor

## Hofmann Combo

### Geodyna® 7100 Balancer and monty® 1270 Tire Service Combo

SKU OUTSIDE BUY/EPO HOFCOMB01TS

- Economical and Practical Package from a Brand You Can Trust
- Small Footprint Wheel Service Package Great for Low Volume Shops
- Great Choice for Second System in High Volume Shops
- Ergonomic and User-Friendly Design



HOFEWH764AU1

HOFEWB761AE1

HOFEWH764AU1	\$4,849.99
HOFEWB761AE1	\$4,849.99
Regular Price	<b>\$9,699.98</b>
<b>COMBO PRICE</b>	<b>\$6,449.99</b>
<b>SAVINGS</b>	<b>\$3,249.99</b>

WARRANTY: 1 Year Parts and 6 Months Labor



Customer Responsible For Offloading, Liftgate Service Available.

For Outside Buy/EPO, Call 901-300-4878

- Free Delivery in 48 Continental United States
- Specifications Subject to Change without Notice or Liability
- Equipment Lead Times and Shipping May Vary
- Customers Responsible for Offloading Equipment Upon Arrival
- Leasing Terms Available, Ask Your AutoZone® Commercial Sales Manager.

Prices subject to change without notice. Prices do not include applicable taxes, vehicles, tires, rims, installation or optional equipment as shown. Please do not return purchases to the store. For information regarding warranty, repair, or any questions or concerns, call 901-300-4878.

AZG0125

97

# TIRE SERVICE

## CEMB Combo

### EZ10 and SM825EVOPA Swing Arm Tire Changer Combo

SKU OUTSIDE BUY/EPO **10,099<sup>99</sup>**  
**CMBCOMBO3**

- Tire Changer Clamping Range of 13" to 24"
- Max. Tire Diameter 44" and Max. Tire Width 15"
- Powerful and Adjustable Bead Breaker Shovel
- Dual Clamping Cylinders and Semi-Automatic Swing Arm
- 3D Wheel Measurement with Sonar
- Automatic Approach and Auto Adaptive Mode to Save Balancing Time
- Electromagnetic Brake
- 3D Inner Data Entry Arm Eliminates Rim Width Caliper Use
- Direct Measures Input Feature Eliminates Selection of Balancing Modes
- Guided Weight Placement, ALU, Hidden Spoke Modes



CMBEZ10



CMBSM825EVOPA

CMBEZ10	\$4,599.99
CMBSM825EVOPA	\$6,199.99
Regular Price	<b>\$10,799.98</b>
<b>COMBO PRICE</b>	<b>\$10,099.99</b>
<b>SAVINGS</b>	<b>\$699.99</b>

On-Site Training Included

WARRANTY: 2 Years Parts and 1 Year Labor



## Baseline Combo

### BL300 Tire Changer and BL350 Balancer Combo

SKU OUTSIDE BUY/EPO **5,649<sup>99</sup>**  
**AMM8500300350**

- Includes: BL300 Tire Changer and BL350 Balancer
- 10" to 24" External Clamping Capacity
- Bead Sealing Jets to Aid Inflation
- BL350 Balancer Features Self Diagnosis and Calibration
- One Button Split and Hidden Weight Program



AMM85002350



AMM85002300

AMM85002300	\$3,349.99
AMM85002350	\$3,099.99
Regular Price	<b>\$6,449.98</b>
<b>COMBO PRICE</b>	<b>\$5,649.99</b>
<b>SAVINGS</b>	<b>\$799.99</b>

WARRANTY: 1 Year Parts



## Ranger Combos

### R980XR and DST-2420 Tire Service Combo

SKU OUTSIDE BUY/EPO **6,899<sup>99</sup>**  
**RANCOMBO1**

- Includes: R980XR NEXTGEN™ Swing-Arm 30" Tire Changer and the DST-2420 Dynamic Wheel Balancer
- R980XR External Rim Clamping Capacity: 9" to 28", Internal Clamping 10" to 30"
- 3-Position RimGuard™ Wheel Clamps
- DST-2420 Dynamic Wheel Balancer Dependably Ensures an Accurate Result within Hundredths of an Ounce



RANDST2420



RANR980XR

**INCLUDES: 74<sup>38</sup> Value Wheel Weight Starter Kit 100-Piece Silver Roll and 100-Piece Black Roll**

RANR980XR	\$4,099.99
RANDST2420	\$2,999.99
Regular Price	<b>\$7,099.98</b>
<b>COMBO PRICE</b>	<b>\$6,899.99</b>
<b>SAVINGS</b>	<b>\$199.99</b>

WARRANTY: 1 Year Parts and Labor

### R980AT and DST30P Tire Service Combo

SKU OUTSIDE BUY/EPO **9,199<sup>99</sup>**  
**RANCOMBO5**

- Inflation Pressure Regulator/Limiter
- Bead Tool/Tire Iron
- Automatic Braking
- Black and Silver Powder-Coated Surface Helps Eliminate Corrosion and Staining of Expensive Wheels
- Low-Profile Design for Increased Clearance of Close-Proximity Calipers or Brake Components



RANDST-30P



RANR980AT

RANR980AT	\$5,999.99
RANDST-30P	\$3,199.99
Tape Wheel Weights Combo	\$209.99
Regular Price	<b>\$9,409.97</b>
<b>COMBO PRICE</b>	<b>\$9,199.99</b>
<b>SAVINGS</b>	<b>\$209.98</b>

WARRANTY: 1 Year Parts and Labor



**BEFORE PLACING YOUR TIRE SERVICE ORDER:**

Please verify minimum air pressure and CFM along with voltage and phase. See page 2 for delivery information or **Call 901-300-4878.**



Customer Responsible For Offloading, Liftgate Service Available.

For Outside Buy/EPO, Call 901-300-4878

- Free Delivery in 48 Continental United States
- Specifications Subject to Change without Notice or Liability
- Equipment Lead Times and Shipping May Vary
- Customers Responsible for Offloading Equipment Upon Arrival
- Leasing Terms Available, Ask Your AutoZone® Commercial Sales Manager.

Prices subject to change without notice. Prices do not include applicable taxes, vehicles, tires, rims, installation or optional equipment as shown. Please do not return purchases to the store. For information regarding warranty, repair, or any questions or concerns, call 901-300-4878.

# TIRE SERVICE

FOR HELP with Selection, Confirm Availability and Ordering Instructions, Call 901-300-4878

TIRE SERVICE

## Tire Changers

### Maxx 50 Tire Changer, 110V

SKU OUTSIDE BUY/EPO AMM800MAXX50E **6,649<sup>99</sup>**

- Dual Nozzle, Hi-Flow Bead Sealing System for Quick, Easy Bead Sealing
- 110V Electric Operation, Plug In Almost Anywhere
- 6" to 24" Steel Clamps Standard
- Nylon Duckhead Standard
- Expanded Capacity to 16" Wheel Width, and Up to 50" Total Diameter



### Maxx 50

#### Tire Changer, Air

SKU OUTSIDE BUY/EPO AMM800MAXX50A **6,649<sup>99</sup>**

WARRANTY: 3 Years Parts and 6 Months Labor

### Maxx 70 Tire Changer, 110V

SKU OUTSIDE BUY/EPO AMM800MAXX70 **8,699<sup>99</sup>**

- Dual Nozzle, Hi-Flow Bead Sealing System for Quick, Easy Bead Sealing
- 110V Electric Operation, Plug in Almost Anywhere
- Expanded Capacity to 16" Wheel Width and Up to 50" Total Diameter
- 6" to 24" Steel Clamps Standard
- Steel and Nylon Duckheads Standard
- No-Index Tabletop for High Efficiency Use



### Maxx 70

#### Tire Changer, Air

SKU OUTSIDE BUY/EPO AMM800MAXX70A **8,699<sup>99</sup>**

### Maxx 70 Tire Changer, 220V, 2 HP

SKU OUTSIDE BUY/EPO AMM800MAXX70220 **8,699<sup>99</sup>**

WARRANTY: 3 Years Parts and 6 Months Labor

### Maxx 80 Tire Changer, 110V

SKU OUTSIDE BUY/EPO AMM800MAXX80 **10,249<sup>99</sup>**

- Dual Nozzle, Hi-Flow Bead Sealing System for Quick, Easy Bead Sealing
- Dual Control, Hand or Foot Operated Bead Loosener System
- 110V Electric Operation, Plug in Almost Anywhere
- 6" to 24" Steel Clamps and Zinc Plated 6" to 24" Grip Max 2.0 Clamps with Dual Soft Compound Inserts
- Expanded Capacity to 16" Wheel Width and Up to 50" Total Diameter
- Steel and Nylon Duckheads Standard
- No-Index Tabletop for High Efficiency Use
- Includes Storage Cabinet



### Maxx 80

#### Tire Changer, Air

SKU OUTSIDE BUY/EPO AMM800MAXX80A **10,249<sup>99</sup>**

### Maxx 80 Tire Changer, 220V, 2 HP

SKU OUTSIDE BUY/EPO AMM800MX80220 **10,249<sup>99</sup>**

WARRANTY: 3 Years Parts and 6 Months Labor

## Coats Wheel Balancers

### 1600A 3D Wheel Balancer

SKU OUTSIDE BUY/EPO AMM80016003D **10,499<sup>99</sup>**

- Powered by Direct Drive
- Max. Tire Diameter: 44"
- Premium Quicknut
- Behind-the-Spoke Balancing
- 8 Piece Collet Kit
- Automatic 3-D Data Entry
- Touch-Screen
- 220V, 1 Phase



WARRANTY: 3 Year Parts and 6 Months Labor

### 1500A 3D Wheel Balancer

SKU OUTSIDE BUY/EPO AMM80015003D **9,249<sup>99</sup>**

- Powered by Direct Drive
- Max. Tire Diameter: 44"
- Behind-the-Spoke Mode
- Premium Quicknut
- 8 Piece Collet Kit
- Automatic 3-D Data Entry
- 220V, 1 Phase



WARRANTY: 3 Year Parts and 6 Months Labor

## CEMB Wheel Balancer

### Automatic Wheel Balancer with Monitor

SKU OUTSIDE BUY/EPO CMBER65 **6,599<sup>99</sup>**

- Auto-Data Entry of Distance, Diameter and Width
- Laser Pointer for Weight Placement
- 17" Monitor with Intuitive Software
- Auto-Approach Positions Wheel at Correction Point
- On-Site Training Included



WARRANTY: 2 Years Parts and 1 Year Labor



Customer Responsible For Offloading, Liftgate Service Available.

For Outside Buy/EPO, Call 901-300-4878

- Free Delivery in 48 Continental United States
- Specifications Subject to Change without Notice or Liability
- Equipment Lead Times and Shipping May Vary
- Customers Responsible for Offloading Equipment Upon Arrival
- Leasing Terms Available, Ask Your AutoZone® Commercial Sales Manager.

Prices subject to change without notice. Prices do not include applicable taxes, vehicles, tires, rims, installation or optional equipment as shown. Please do not return purchases to the store. For information regarding warranty, repair, or any questions or concerns, call 901-300-4878.

AZG0125

99

# TIRE SERVICE

FOR HELP with Selection, Confirm Availability and Ordering Instructions, Call 901-300-4878

## Ranger

### R76ATR Tilt-Back Tire Changer with Assist Tower

SKU OUTSIDE BUY/EPO  
RANR76ATR

**6,199<sup>99</sup>**

- Motor: 3 HP/220V
- Alloy and Nylon Mount and Demount Heads
- External Rim Clamping Capacity: 9" to 28"
- Power Assist Tower Right Side
- Available in 110V or 220V Power Option



### R980AT RimGuard™ Swing-Arm and Assist Tower Tire Changer

SKU OUTSIDE BUY/EPO  
RANR980AT

**5,999<sup>99</sup>**

- Motor: 3 HP/220V
- Internal Rim Clamping Capacity: 10" to 30"
- External Rim Clamping Capacity: 9" to 28"
- Max. Tire Diameter: 50"
- Power Assist Tower Left Side
- Available in 110V or 220V Power Option

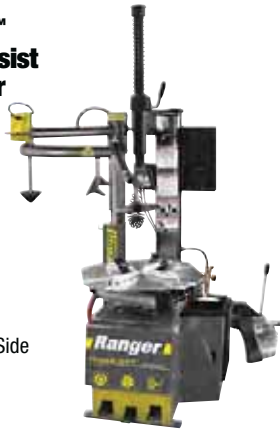

### R980XR NextGen™ Swing-Arm Tire Changer

SKU OUTSIDE BUY/EPO  
RANR980XR

**4,099<sup>99</sup>**

- Motor: 3 HP/220V
- Drive System Type: Electric/Air
- Adjustable RimGuard™ Wheel Clamps
- External Rim Clamping Capacity: 9" to 28"
- Internal Rim Clamping Capacity: 10" to 30"
- Max. Tire Diameter: 50" (1,270 mm)
- Bead Seating System: Turbo Blast/Bead Seating



### DST30P Direct Drive Wheel Balancer

SKU OUTSIDE BUY/EPO  
RANDST-30P

**3,199<sup>99</sup>**

- Ergonomic Control Board and Easy-to-Read LED Display
- Dynamic, Static and Performance Alloy Settings
- Automatic Rolling Wheel Parameter Setting
- Low RPM Balancing Speed
- Automatic Braking
- Quick-Release Hub Nut
- Wheel Width Capacity: 1.2" to 20"
- Max. Wheel Diameter: 8" to 30"



### LS43B Wheel Balancer

SKU OUTSIDE BUY/EPO  
RANLS43B

**4,299<sup>99</sup>**

- Included Cones: 3 Standard, 1 Truck
- Cycle Time: 6 Seconds (Avg.)
- Balancing Modes: Dynamic/Static/3-Alloy
- Max. Tire Diameter: 43" (1,100 mm)
- Max. Tire Weight: 145 Lb. (65 kg)
- Wheel Diameter Capacity: 12" to 26" (304 mm to 660 mm)
- Wheel Width Capacity: 4" to 15" (102 mm to 381 mm)



**INCLUDES: 74<sup>38</sup> Value**  
Wheel Weight Starter Kit 100-Piece Silver Roll and 100-Piece Black Roll

**INCLUDES: 74<sup>38</sup> Value**  
Wheel Weight Starter Kit 100-Piece Silver Roll and 100-Piece Black Roll

User Set-Up Required

WARRANTY: 1 Year Parts and Labor

**Do you work on Trucks, Vans, or SUVs?**  
**DON'T FORGET THIS ACCESSORY**

### 40 mm Truck Cone Kit

SKU OUTSIDE BUY/EPO | RAN5150032

**489<sup>99</sup>**

Works with Ranger Wheel Balancers Listed on This Page



## Hofmann

### Monty® 3550EM Tire Changer with smartSpeed™

SKU OUTSIDE BUY/EPO  
HOFEWH747B

**12,349<sup>99</sup>**

- smartSpeed™ Technology Automatically Controls Turntable Speed and Torque to Minimize Tire and Wheel Damage
- Push-Button Controlled Mount/Demount Head Pneumatically Lowers and Locks into Position. Automatically Indexing Away from the Wheel to Prevent Contact and Damage
- Fast and Ergonomic Pneumatic Vertical Arm Automatically Re-Positions the Mounting Head to Minimize Wheel Damage
- High Capacity Tire Changer Allows for Broadest Tire and Wheel Assembly Coverage
- Clamping Range: Inside 12" to 28"; Outside 12" to 26"
- Max. Tire Diameter: 47"
- Max. Tire Width: 17"



WARRANTY: 1 Year Parts and 6 Months Labor

## HOFMANN

### Geodyna® 7600P with Laser and Power Clamp

SKU OUTSIDE BUY/EPO  
HOFEWB765AP

**9,049<sup>99</sup>**

- Power Clamp Clamps Wheel Accurately with Constant Force
- Smart Sonar™ Delivers Automatic, Non-Contact Rim Width
- Acquisition Split Weight Mode, Allows Exact Placement of Weights Behind Spokes



WARRANTY: 1 Year Parts and 6 Months Labor

## Manatec



### DL-65 DSP C Wheel Balancer

SKU OUTSIDE BUY/EPO  
MANDL65-DSPC

**1,499<sup>99</sup>**

- Static and Dynamic Balancing
- Automatic Start with Wheel Guard Closure
- Unbalance Recalculation
- Self-Calibration
- 7 Modes of Alloy Wheel Functions
- Normal and Fine Measurement
- Motor Power: 0.35 HP
- Maximum Wheel Diameter: 39"



WARRANTY: 1 Year Parts



Customer Responsible For Offloading, Liftgate Service Available.

For Outside Buy/EPO, Call 901-300-4878

- Free Delivery in 48 Continental United States
- Specifications Subject to Change without Notice or Liability
- Equipment Lead Times and Shipping May Vary
- Customers Responsible for Offloading Equipment Upon Arrival
- Leasing Terms Available, Ask Your AutoZone® Commercial Sales Manager.

## TPMS Tools

### VT37 TPMS Sensor Activation and Programming Tool

SKU 1343925 **279<sup>99</sup>**  
ATEVT37-0000

- Search TPMS Sensor Replacement Part Numbers
- Test Keyfob Signal Strength/Battery Status
- Install and Service TPMS Retrofit Kits

Includes 2 Years Software Updates and 1 Year Warranty



### VT67 TPMS and Tire Management Diagnostic Tablet

SKU OUTSIDE BUY/EPO **1,399<sup>99</sup>**  
ATESM67-8BLE

- Secure Gateway (SGW) Ready for Stellantis Vehicles
- Save, Manage and Edit Customer Jobs and Reports on the Cloud
- Program and Clone 20+ Aftermarket Sensor Brands
- Export and Send Complete Customer Reports via Email
- TPMS Sensor and Service Kit Image Library for Easy Reference
- ID Match Functionality to Troubleshoot and Repair TPM Systems
- Tire Management: Tread Reading, Wheel Inspection, Tire Registration
- Built-In HD Camera for Accurate Vehicle and Wheel Inspection

Includes 8 Bluetooth Sensors

**VALUE: \$479.92**

Includes 1 Year Software Updates and 1 Year Warranty



### VT47 TPMS Programming Tool

SKU OUTSIDE BUY/EPO **729<sup>99</sup>**  
ATESM47-12SC

- TPMS Sensor Part Number Look-Up (OE and Aftermarket)
- Change Placard Values When Swapping Tire Sizes
- Includes: 12 Dual Band Sensors with Both Metal and Rubber Valve Stems

Includes 12 Dual Band Sensors

**VALUE: \$299.88**

Includes 5 Years Software Updates and 1 Year Warranty



### VT57 TPMS and Tire Management Tool

SKU OUTSIDE BUY/EPO **1,099<sup>99</sup>**  
ATESM57-20SC

- All-New Updated User Interface
- Touch-Screen Capability
- Includes: 20 Sensors Dual Band Sensors with Both Rubber and Metal Valve Stems

Includes 20 Dual Band Sensors

**VALUE: \$499.80**

Includes 5 Years Software Updates and 1 Year Warranty



### Dual Band TPMS Sensor

SKU OUTSIDE BUY/EPO **24<sup>99</sup>**  
SIMSM-1SC

- Dual Band TPMS
- Aluminum and Rubber Valve Included
- 98% Coverage Tested and Validated in USA
- Live Tech Support



### Bluetooth Pre-Programmed Sensors

SKU OUTSIDE BUY/EPO **59<sup>99</sup>**  
SIMSM-BLE

- Tesla, OE Like
- Future Proof, OE Like
- Plug and Play
- Black Valve
- Live Tech Support



### TPMS Tool Kit Assortment

SKU OUTSIDE BUY/EPO **134<sup>99</sup>**  
XTS17-168

- Features All the Small TPMS Tools Necessary for TPMS Service
- Includes: Valve Core Torque Tool, Grommet Removal Tool, Nut Torque Wrench with Sockets, T-10 Torque Tool and Grommet Removal Pick
- Comes in a High Quality Blow Mold Storage Case



For Outside Buy/EPO, Call 901-300-4878

## FUNCTIONALITY

	VT37	TS47	TS57	VT67
Reads, Diagnoses and Activates 100% of OE and Aftermarket Sensors, Including 2022 Coverage	✓	✓	✓	✓
VIN Barcode Scanner to Select Make, Model and Year			✓	✓
Wi-Fi and Real-Time Updates Powered by Live Sensor™		✓	✓	✓
Programs Aftermarket Sensors (Including EZ-Sensor® and All Leading Brands)	✓	✓	✓	✓
Secure Gateway (SGW) Ready for Stellantis Vehicles and Others				✓
Provides Direct (OBD, Auto, Manual) and Indirect TPMS Relearn Procedures	✓	✓	✓	✓
98.6% TPMS Reset Coverage, Including Bonus ECU Reset Coverage in <2 Min. (OBD Connectivity)		✓	✓	✓
ECU Unlock for Toyota, Scion and Lexus Models (Closed Loop)		✓	✓	✓
OE and Aftermarket TPMS Sensors and Service Kits Part Number Look-Up	✓	✓	✓	✓
Save, Manage and Edit Customer Jobs and Reports on the Cloud				✓
Retrieves, Decodes and Clears TPMS DTCs		✓	✓	✓
Tire Management, DOT, Tread Reading and More		✓	✓	✓

## Wheel Stud Tools

### 8 Piece Wheel Stud Alignment Guide Kit

SKU 818715 **41<sup>99</sup>**  
24233

- Makes the Job Faster and Easier Allowing the Tech to Safely Position the Wheel Prior to Installing the Wheel Bolts
- Applications: Mercedes-Benz, BMW, Audi, VW, Porsche, Fiat and Dodge
- Sizes Included:  
12 mm x 1.5, 12 mm x 1.25, 14 mm x 1.25 and 14 mm x 1.75



### Wheel Stud Installers

SKU 339123 **12<sup>99</sup>**  
24234

- Works with Hubs, Rotors and Axles on Both Front and Rear Wheel Drive Vehicles
- Prevents Damage to Lug Nut or New Stud
- Designed to Fit Studs Up to 14 mm or 9/16"



### Truck Wheel Stud Installer

SKU 339117 **15<sup>99</sup>**  
24235

- Designed to Work on Truck Wheel Studs Up to 22 mm (7/8") in Diameter
- Use with an Impact Wrench or Ratchet



### Wheel Stud Installer Set for Cars and Trucks

SKU 339125 **22<sup>99</sup>**  
24236

- Set Includes Both 24234 and 24235



**OEM TOOLS**

**22<sup>99</sup>**  
REG. \$28.98

**SAVE OVER \$5**

When You Buy the Set

# TIRE SERVICE

CALL FOR PRICE

**Tesla-ready & programmable for new vehicles with Bluetooth TPMS for smarter, more connected tires**

**Adjustable-Angle Sensor**  
15°-34° for a more secure fit for a broader range of vehicles.



**MaxiTPMS® MX-Sensor BLE**  
SKU 1366285 Part #300100

- Pre-programmed Bluetooth Low Energy TPMS sensors for Tesla 3/Y/S/X models
- Tesla-ready: Just Fit and Go
- Future-proof: programmable with Autel TPMS tools for the latest BLE-equipped vehicles

**MaxiTPMS® TS508 WiFi Kits**  
SKU 1328117 Part #700180

- Update software directly from tool-enabled Wi-Fi
- Quick Mode & Advanced Mode Options
- Read/Activate/Relearn All Known Sensors
- Detect & Display TPMS System Faults
- Display Vehicle-Specific Relearn Procedures; Perform OBDII Relearns
- Placard Value Reset on Supported Vehicles
- 2 Programming Options: MX-Sensors Only
- FREE Software for lifetime of tool
- 4 1-Sensors & Metal Valve Included
- SKU 1413611 Part #700190
- 20 1-Sensors Included



AUTEL MAXI TPMS

CALL FOR PRICE

**MaxiTPMS® 1-Sensor**  
SKU 317455 Part #1SENSOR

- Combined Frequency: 315MHz & 433MHz
- Interchangeable Valve Stems (rubber included)
- Program to Replace 99% of OE Sensors
- Fast valve stem swap



**MAXI TPMS® 1-SENSORM**  
SKU 1064478 Part #1SENSORM

- Same as 1-Sensor with Aluminum stem



**MaxiTPMS® 1-Sensor 20-Pack (R)**  
SKU 370328 Part #300010

- Bulk pack of 20 1-Sensors with Rubber Valves



**MaxiTPMS® 1-Sensor 20-Pack (M)**  
SKU 1107286 Part #300060

- Bulk pack of 20 1-Sensors with Aluminum Valves

**MaxiTPMS® 1-Sensor 240 Pack**  
SKU 1089240 Part #300050

- Bulk pack of 240 1-Sensors with Rubber Valves



**MaxiTPMS® 1-Sensor 100 Pack**  
SKU 1128315 Part #300070

- Bulk pack of 100 1-Sensors with Rubber Valves

**MaxiTPMS® TS900** SKU 1337325 Part #TS900

- Activate, Read, and Relearn ALL known TPMS sensors, including Tesla OE sensors
- Program universal Autel 1-Sensors to replace 99% TPMS sensors
- Compatible with BLE TPMS sensors and Autel BLE Sensor for Tesla vehicles
- Features Android 11 operating system and 64GB storage memory
- All Systems Diagnostics with bi-directional controls, Active Tests & Special Functions



**MaxiSYS® MS906PRO-TS**  
SKU 1207797 Part #MS906PROTS

- AutoVIN 2006+ /AutoSCAN
- 21 Service Functions
- Wi-Fi Software Updates
- Eligible for ADAS Software Upgrade
- Advanced Coding & Adaptations

**MaxiTPMS® ITS600PRO1**

SKU 1140847 Part #ITS600PRO1

- Complete TPMS Service and Diagnostics Tablet
- 5.5 Inch Color Touchscreen/Android 9.0 OS
- Activates, Reads and Relearns All Known Sensors
- On-Tool DOT Tire Registration
- 2 MX-Sensor Program Modes



USE TOGETHER TO CREATE A COMPLETE TPMS SYSTEM HEALTH REPORT



**MaxiTPMS® TBE200**  
SKU 1129878 Part #TBE200

- Tire Tread and Brake Disc Wear Examiner
- Laser-Enabled; No Need to Remove Tire
- 1.65" AMOLED Super Retina, Color Touchscreen Display
- Full Color Graphical Display Illustrates Wear
- Displays Recommendations for Tire and Brake Disc Replacement, 4-wheel Alignment and Tire Rotation
- 4-megapixel, 4 cm Macro Camera and 8-megapixel Zoomable Camera to Document Tire Damage

AUTEL

## Inflators

OEM TOOLS

### Digital Tire Inflator

SKU 802198 24412 **69<sup>99</sup>**

- Easy-to-Read Backlit LCD Display
- 4 Units of Measure (psi, Bar, KPa, kgf)
- Measuring Range: 0 to 175 psi (0 - 12 Bar)
- Accuracy: +/-1.2 psi Up to 58 psi, +/-2.3 Between 58 psi and 145 psi Inclusive, +/-3.6 psi Greater Than 145 psi
- High Air Flow Saves the Technician Time
- Includes: 2 AAA Batteries



### Dial Tire Inflator

SKU 301772 24380 **59<sup>99</sup>**

- Clear and Easy-to-Read 80 mm 180 psi Gauge
- 3-In-1 Function: Inflate, Deflate and Measure Tire Pressure
- Increased Accuracy to Improve Tire Performance and Prevent TPMS Comebacks



OEM TOOLS

### 3.5" Digital Tire Inflator with Hose

SKU 1268419 AST3018 **129<sup>99</sup>**

- 21" Stainless Braided Hose
- Dual AAA Battery Powered Design
- Backlit LCD Digital Read-Out
- Includes Batteries



Astro

### Inflator Gauge, Dual Head Chuck Tire Inflator Gauge

SKU OUTSIDE BUY/EPO MILS506 **74<sup>99</sup>**

- Heavy Duty Construction Provides for Long Life Even Under Heavy Use and Extreme Conditions
- Gauge and Valve Cartridges are Replaceable
- Equipped with Magnifying Lens for Full View of Scale



For Outside Buy/EPO, Call 901-300-4878

MILTON INDUSTRIES, INC.

## Bead Seater

OEM TOOLS

### 5 Gallon Bead Seater

SKU 526505 24449 **99<sup>99</sup>**

- Seats Beads on All Tires, from Small 4" Tires to 24-1/2" Truck Tires
- Operates on Standard Shop Air; Max. 120 psi



## Air Chuck

### Dual Foot Air Chuck with Comfort Grip Handle

SKU 802201 24413 **24<sup>99</sup>**

- Comfortable Screwdriver Style Handle
- 30° Reverse Angle Chuck Can Be Used on Outside Tires
- Tilt Lock Feature Locks onto the Valve



### Air Chuck with Comfort Grip Handle

SKU 802200 24414 **19<sup>99</sup>**

- Durable, OEMTOOLS Screwdriver Style Handle for Comfort and a Positive Grip
- Sealed-Ball Air Chuck is Extended 1" from Handle to Allow Access to Tight Areas







OEM TOOLS

# TIRE SERVICE

TO ORDER, contact your Commercial Sales Manager or go to [AutoZonePro.com](http://AutoZonePro.com)

TIRE SERVICE

Mount/Demount Heads	Fits	Models	OE Part Number		Fits	Models	OE Part Number
<b>Red Nylon Mount/Demount Head</b> SKU 1137811 <b>39<sup>99</sup></b> SHA35034 	Hunter	TC250, TC300, TC325, TC350, TC2000, TC3250, TC3500, TC3000 and TC3100 Series	221-615-2-13	<b>Nylon Mount/Demount Head without Hardware</b> SKU 1125892 <b>44<sup>99</sup></b> SHA35033 	Accuturn	3602, 3602HP, 4260, 4560MR, 4602, 5602 and 5602 HP	2002433, 14024784
	Accuturn	(Requires Adapter) 220A, All Other Models Require 102765 Adapter	SM102529		Hofmann	1520, 1565, 1620, 1625EM, 3300, 3300EM, 1270, 2300, 3000 and 3000GP	4024784, ST0024335
	Ranger	R980X Rev A Models, R980XR/NXT, R30XLT, RX-850/950-B Models, R23/23ST, R26ST/26EX, R745 and R710 Models ONLY. Require RAN5150524 Adapter	5150523		John Bean	EHP System IVE, IV, III, IIE	2433, EAA 0247G20A
<b>Nylon Mount/Demount Tapered Hole Head with Hardware</b> SKU 1137818 <b>39<sup>99</sup></b> SHA38306 	Coats	5030, 5040, 5045, 5050, 5060, 5065, 6050, 6060, 6065, 7050, 7055, 7060, 7065, 7660, 7665, 50X, 60X, 70X, 80X, GTS, RC45, RC55, Maxx50, 70 and 80	8183061	<b>Nylon Mount/Demount Head with Hardware</b> SKU 1442589 <b>54<sup>99</sup></b> TMRTC14024784 	Accuturn	3602, 3602HP, 4260, 4560MR, 4602, 5602 and 5602 HP	2002433
	Baseline	BL200, BL300, BL400 and BL500	8183061		Hofmann	1520, 1565, 1620, 1625EM, 3300, 3300EM, 1270, 2300, 3000 and 3000GP	4024784
<b>Low Profile Mount/Demount Head</b> SKU 1125869 <b>59<sup>99</sup></b> SHA35038 	Coats	Replacement for Coats 8184432. For use on Models RC100, RC150, RC200, 5030, 5035, 5040, 5045, 5050 Series, 5060 Series, 5065 Series, 6050, 6060, 6065, 7050, 7055, 7060, 7065, 7655, 7660, 7665, BL200, BL300, BL400 and BL500	8184432	<b>Nylon Mount/Demount Head with Round Hole Kit</b> SKU 1137815 <b>99<sup>99</sup></b> SHA35030 	John Bean	EHP System IVE, IV, III, IIE	24335
	Coats				Snap On	All Models	24335
<b>Nylon Mount/Demount Head</b> SKU 1125877 <b>39<sup>99</sup></b> SHA35031 	Coats (Early)	5060, 50601, 5063, 5060AX, 5060EX and 9010A, 9010E, 9024E-PAX and Many RC Models	8300843	All Tool	All Models	2008401	
	CEMB	All Models	3008403, 2008402	Coats	RC1, 5, 10, 15, 20, Early 5060, 9010, 9024 and APX90	83008402, 83008403	
	Hofmann	12SE, 22SE, 1510, 1610, S410 Not for Use on Hofmann 1550, 1620 and 1625	8314813	Corghi	All Rim Clamp	250309, 450310	
	Other	Fits Many Hunter TCX Series, Fits Giuliano and SICE Machines	Various	Hofmann	Earlier Models Except 1550, 1620 and 1625	8314813	
				Sice	M39, S40, S42, S43, S45, S408MAXI, S435, S436 and S436TC	8314813	

## Bead Lifting Tool



### 20" Bead Lifting Tool - 3 Pack

SKU 1142616 **19<sup>99</sup>**  
26036

- For Use with Any Make of Tire Changer and Tire Combination
- Curved End to Prevent Tire Damage
- Can Be Used for Both the Removal and Mounting of Tires
- Heat-Treated for High Strength and Durability



## Rim Protectors



### 12 Pack Plastic Insert Rim Protectors for Coats Stainless Steel Mount/Demount Head

SKU 1400044 **19<sup>99</sup>**  
TMRT1182963

- For Coats Stainless Steel Mount/Demount Head Coats 8182961 (2 Pk.) RC1, 5, 10, 15, 20 8182963 (12 Pk.) Early 5060, 5030, 5040, 5050, 5060, 5065 5070, 6050, 6060, 6065, 7050, 7055, 7060 7065, 7655, 7660 and 7665



## Hybrid Duckhead Tail - 2 Pack



SKU 1442586 **44<sup>99</sup>**  
AMM8560896102

- Designed to Float Across the Rim, Decreasing the Stretching of the Bead
- Compatible with Hybrid Duckhead® Mount/Demount Tool (85608959)
- Compatible with All X-Series and RC Series That Have Hybrid Duckhead® Mount/Demount Tools



Prices subject to change without notice. Prices do not include applicable taxes, vehicles, tires, rims, installation or optional equipment as shown. Please do not return purchases to the store. For information regarding warranty, repair, or any questions or concerns, call 901-300-4878.

# TIRE SERVICE

## Non-Marring Lug Nut Sockets

### 1/2" Drive 17 mm Mercedes-Benz® Flower Lug Bolt Impact Socket

SKU 081308  
24469 **13<sup>99</sup>**

- Designed Specifically for 17 mm, Convex "Flower" Shaped Mercedes Lug Bolts



**OEM TOOLS®**

### 9 Piece Thin-Wall Wheel Protector Impact Socket Set

SKU 965856  
24224 **74<sup>99</sup>**

- Sizes: 3/4", 7/8", 13/16", 15/16", 1", 1-1/16", 17 mm, 19 mm and 21 mm

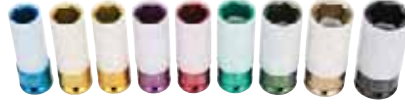

## Lug Nut Sockets

**OEM TOOLS®**

### Master Lug Nut Kit

SKU 1190208  
68919

- Includes: 2 Socket Sets for Removing, Locking, Damaged and Undamaged Lug Nuts on Most Vehicles
- Ideal for Removal of Warped and Mangled Chrome-Cap Style Lug Nuts
- Easily Removes Locking Lug Nuts on Most Aftermarket Wheels



**89<sup>99</sup>**

REG. \$109.98

**SAVE OVER \$19**  
When You Buy the Kit

### 3 Piece Extra Thin-Wall Wheel Nut Protector Impact Socket Set

SKU 094646  
25583 **24<sup>99</sup>**

- Blue - 17 mm/11/16", Gold - 19 mm/3/4" Red - 21 mm/13/16"



### 1/2" Drive Non-Marring Lug Nut Socket Set

SKU OUTSIDE BUY/EPO  
68945

- Services 17 mm, 19 mm, 21 mm and 22 mm Lug Nuts
- Non-Marring Sleeve Prevents Damage of Lug Nuts and Wheel Rims
- CR-MO Steel Construction for Strength and Durability



Impact Wrench Not Included

**29<sup>99</sup>**

REG. \$59.96

**SAVE OVER \$29**  
When You Buy the Kit

### 16 Piece Locking Lug Master Key Set

SKU 626107  
24447 **79<sup>99</sup>**

- Easily Removes Locking Lug Nuts on Most Aftermarket Wheels
- Thin-Wall Sockets Prevent Damaging Wheels and Lugs
- Hex-Head Design Fits Most Lug Wrenches as well as 13/16" and 7/8" Sockets



### 4 Piece Deep Thin-Wall SAE and Metric Impact Flip Socket Set

SKU 965857  
24223 **29<sup>99</sup>**

- Includes: 3/4" to 13/16", 19 mm to 21 mm and 7/8" to 15/16" Sockets and 3" Extension

Flip Sockets



### 5 Piece 1/2" Drive Flip Socket Set

SKU 1125891  
25555 **29<sup>99</sup>**

#### Half Metric Sizes for Removal of Warped and Mangled Chrome-Cap Style Lug Nuts

- Durable CR-MO Flip Socket Set
- Includes: 18.5 mm x 19.5 mm, 19 mm x 21 mm, 21 mm x 21.5 mm, 22 mm x 22.5 mm and 1/2" Drive Extension



### 3 Piece Super Strength Wheel Nut Impact Socket Set

SKU 347212  
24227 **29<sup>99</sup>** REG. \$39.99

- Blue - 17 mm/11/16" Gold - 19 mm/3/4" Red - 21 mm/13/16"



**SAVE \$10**

Offer Good While Supplies Last Through  
March 31, 2025

## Torque Limiting Set

**OEM TOOLS®**

### 5 Piece 1/2" Drive Torque Limiting Extension Set

SKU 965858  
24220 **54<sup>99</sup>**

- Quick, Simple and Accurate
- Helps Prevent Lug Stud/Nut Damage and Warped Rotors
- Includes 1/2" Drive Extensions: 65 Ft/Lb., 80 Ft/Lb., 100 Ft/Lb., 120 Ft/Lb. and 140 Ft/Lb.
- Made with Flexible Chromoly Steel that Stops Turning When the Required Torque is Reached
- Comes in a Sturdy Blow Mold Case



## Torque Wrenches

### 3/8" Drive 10-80 Ft/Lb.

SKU 177722  
25694 **59<sup>99</sup>**

### 1/2" Drive 10-150 Ft/Lb.

SKU 012651  
25689 **69<sup>99</sup>**

### 1/2" Drive Undercar Torque Wrench

SKU OUTSIDE BUY/EPO  
CEN97354A **319<sup>99</sup>**

- Unique One-Way Design Cannot Be Used as a Breaker Bar (thus Preventing Damage)
- High Contrast Laser Markings for Easier Reading
- Rubber Over-Mold Lock Ring for Better Grip
- Head and Handle Covers for Increased Durability
- Range: 25 to 250 Ft/Lb. (43.4 to 348.4 Nm)
- Length: 23.3"

For Outside Buy/EPO, Call 901-300-4878

### 1/2" Drive 25-250 Ft/Lb.

SKU 177715  
25695 **99<sup>99</sup>**



25695

**OEM TOOLS®**

**Central TOOLS, Inc.**  
QUALITY AND INNOVATION SINCE 1988





# TIRE SERVICE

TO ORDER, contact your Commercial Sales Manager or go to [AutoZonePro.com](http://AutoZonePro.com)

TIRE SERVICE

## Tire Service Tools



### 2 Piece Tire Valve Core Tool Set

SKU 1209377  
22589 **12<sup>99</sup>**

- Designed for Removal and Installation of Schrader Style Valve Cores
- Includes: 2" and 5" Tools
- Extra-Long 5" Tool for Hard-to-Reach Applications
- Tough Impact and Solvent-Resistant Acetate Handle



### Spare Tire Removal Set

SKU 749919  
24219 **69<sup>99</sup>**

- 32" Reach Allows Access to Spare Tires Stored on the Undercarriage of Pickups, Vans and SUVs
- Includes: 6 Zinc-Plated Steel Attachments That Fit a Range of Vehicle Types, Hand Crank and Heavy Duty Nylon Pouch
- No Additional Tools Needed



Attachments Included



### Quick Change Wheel Stud Cleaner Kit

SKU 666299  
CAL16 **69<sup>99</sup>**

- Kit Includes: 1/2" Drive Adapter and 6 Brushes
- Brush Sizes: 7/16" (12 mm), 1/2" (13 mm), 9/16" (14 mm), 5/8" (16 mm), 7/8" (22 mm) and 1-1/8" (28 mm)



## Tire Repair

### Puncture Repair Set

SKU OUTSIDE BUY/EPO  
XTS14-662 **179<sup>99</sup>**

- Includes Puncture Repair Procedures Guide and 20" x 32" Shop Poster
- Enough Supplies to Provide More Than 70 Complete Repairs



For Outside Buy/EPO, Call 901-300-4878

### Tire Repair Cabinet Assortment

SKU OUTSIDE BUY/EPO  
XTS14-603 **649<sup>99</sup>**

- Deluxe Wall-Mount Cabinet
- Loaded to Complete Over 110 Industry Standard Puncture Repairs
- All the Tools Plus XLIGHT Air Powered Vacuum Carbide Cutters and More



For Outside Buy/EPO, Call 901-300-4878

### Euro-Paste (White) 6-1/2 Lb. Tub

SKU OUTSIDE BUY/EPO  
XTS14-700 **18<sup>99</sup>**

- Very Slippery
- No Mixing or Water Required
- Dries Tacky
- Rust Inhibitors



For Outside Buy/EPO, Call 901-300-4878

### Mounting/Demounting Compound (2 Pack)

SKU OUTSIDE BUY/EPO  
XTS14-708EPK **49<sup>99</sup>**

- Very Slippery
- No Mixing or Water Required
- Dries Tacky
- Rust Inhibitors
- Works Great with Low Pro, Run Flat and Alloy Wheel Applications
- Mounting and Demounting Compounds to Prevent Damage to Tire Bead



For Outside Buy/EPO, Call 901-300-4878

### 11" Cotton Tire Swab (6 Pack)

SKU 666324  
XTS14-378PK **21<sup>99</sup>**

- Professional Quality Tire Repair Tool
- Use to Spread Mount/Demount Lube on Bead of Tire

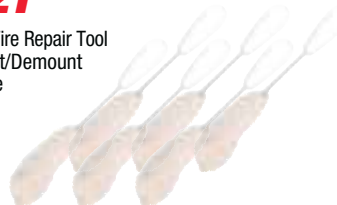

### Xtra Slick Tire Bead Lube (2 Pack)

SKU 1281603  
XTS14-753PMPK **23<sup>99</sup>**

- Ready-to-Use Mounting and Demounting Compounds to Prevent Damage to Tire Bead
- Pre-Mixed



### 8 Oz. Vulcanizing Cement (3 Pack)

SKU 666342  
XTS14-008PK **24<sup>99</sup>**

- Fast Drying
- Can Be Used with Heat Vulcanization



### Tire Buffing Cone

SKU 1142704  
24479 **15<sup>99</sup>**

- Tungsten Carbide Wheel for Fast and Effective Surface Preparation
- 3/8" Quick Disconnect Arbor
- Max. RPM: 5,000



### 57 Piece Tire Repair Kit

SKU 213119  
26686 **29<sup>99</sup>**

- Includes: T-Handle Plug Insert Tool, T-Handle Reaming Tool, Replacement Insert Needle, Long Nose Pliers, Hex Keys, 30 Repair Plugs, Utility Knife, Lubricant, Valve Cores, Valve Caps, Valve Stems and a Valve Core Tool



### Refill Plugs for Any OEMTOOLS® Tire Repair Kit

#### Repair Plug Refill Sets

- For Use with 26680, 26682, 26683 and 26686

**30 Pack**  
SKU 477063  
26684 **8<sup>99</sup>**

**100 Pack**  
SKU 477176  
26685 **14<sup>99</sup>**



Prices subject to change without notice. Prices do not include applicable taxes, vehicles, tires, rims, installation or optional equipment as shown. Please do not return purchases to the store. For information regarding warranty, repair, or any questions or concerns, call 901-300-4878.

# TIRE SERVICE

## Tire Spreaders



### 5025 Tire Spreader

SKU 757051  
BRA00-0161

**429<sup>99</sup>**

- Self-Locking Spread Arms
- 4 Horizontal and 2 Vertical Adjustments
- Handles Any Passenger Tire, Including Low Profiles
- Quick Pin Adjustment with Lanyard



### Heavy Duty Tire Spreader

SKU OUTSIDE BUY/EPO  
XTS14-987

**299<sup>99</sup>**

- Simple and Durable Design Makes Tire Service Faster and Easier
- Height Adjustment for Stabilizing Low-Profile Tires
- Adjustable Range to Handle All Passenger and Light Truck Tires



For Outside Buy/EPO,  
Call 901-300-4878



## Test Tank



### Tire Tube Test Tank

SKU 291382  
LIS19822

**99<sup>99</sup>**

- Tank Features Reinforcement Ribs for Extra Support
- Will Handle Passenger Tire Sizes to Wide Oval and Light Duty Truck Tires
- Dimensions: 31" (L) x 12" (W) x 12" (H)



CALL YOUR COMMERCIAL SALES MANAGER TO ORDER YOUR WHEEL WEIGHTS TODAY

## Wheel Weight Kits

- Steel Weights are More Environmentally Friendly Compared to the Lead Weight Alternative
- Premium Powder Coated Finish Resists Chips and Scratches Which Helps Prevent Damage and Corrosion to Wheels



### Complete Wheel Weight Kit with Floor Rack

SKU 1392466  
68953A

- Includes 78 Boxes of Coated Clip-On Wheel Weights
- ALFE, LHFE, MCFE, PFE, TFE, ENFE, FNFE and IWFE
- 25 Weights per Box
- All Metal Floor Rack

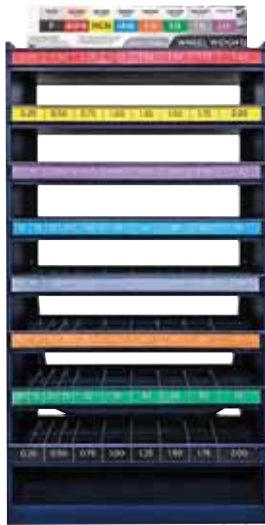

- ALFE Steel
- LHFE Steel
- MCFE Steel
- PFE Steel
- TFE Steel
- ENFE Steel
- FNFE Steel
- IWFE Steel

**999<sup>99</sup>**

REG. \$1,579.21

**SAVE OVER \$579**

When You Buy the Kit

### Adhesive Wheel Weight Starter Kit with Stand

SKU 1392467  
68955A

- Includes: 4 Boxes and 2 Rolls of Adhesive Wheel Weights
- 3 Boxes of Strips, .25 Oz, .50 Oz. and 1.00 Oz.
- 1 Box of .25 Oz. Strips, Black
- (2) 10 Lb. Rolls of .25 Oz. and .50 Oz.
- Wheel Weight Dispenser Stand



**349<sup>99</sup>**

REG. \$467.93

**SAVE OVER \$117**

When You Buy the Kit

## Wheel Weights Only



### Complete Wheel Weight Kit, Weights Only

SKU 1392468  
68954A

- Includes 78 Boxes of Coated Clip-On Wheel Weights
- ALFE, LHFE, MCFE, PFE, TFE, ENFE, FNFE and IWFE in the Most Popular Sizes
- 25 Weights per Box

- ALFE Steel
- LHFE Steel
- MCFE Steel
- PFE Steel
- TFE Steel
- ENFE Steel
- FNFE Steel
- IWFE Steel

**599<sup>99</sup>**

REG. \$1,209.22

**SAVE OVER \$609**

When You Buy the Kit

### Wheel Weight Starter Kit, Weights Only

SKU 1392326  
68952

- Includes: 18 Boxes of Coated Clip-On Wheel Weights
- ALFE, MCFE and PFE in the Most Popular Sizes
- 25 Weights per Box

- ALFE Steel
- MCFE Steel
- PFE Steel

**129<sup>99</sup>**

REG. \$231.72

**SAVE OVER \$101**

When You Buy the Kit

### Wheel Weight Starter Kit with Floor Rack

SKU 1339729  
OEMREPLENKITA

- Includes: 18 Boxes of Coated Clip-On Wheel Weights
- ALFE, MCFE and PFE in the Most Popular Sizes
- 25 Weights per Box
- All Metal Floor Rack

- ALFE Steel
- MCFE Steel
- PFE Steel

**499<sup>99</sup>**

REG. \$601.00

**SAVE OVER \$101**

When You Buy the Kit



# BRAKE SERVICE

FOR HELP with Selection, Confirm Availability and Ordering Instructions, Call 901-300-4878

## Brake Lathe Kit



### Combination Bench Lathe Kit

SKU OUTSIDE BUY/EPO **13,449<sup>99</sup>**  
PCTB-17K

- Features Adapters and Accessories for All Passenger Vehicles and Light Trucks
- Resurfaces Brake Drums and Discs to Exceed OEM Specs for Surface Finish in 1 Pass
- Switch from Drums to Rotors in Seconds
- Includes: Dust Collection System and Side Work Table

On-Site Installation and Training Included

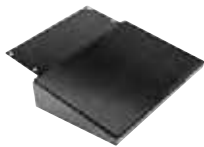

PCT50-4720



PCT50-4280



PCTB-17

**BONUS VALUE: \$1,099.99**



### Quick Chuck Kit

PCT50-4250K

With Purchase of PCTB-17K

Offer Good While Supplies Last Through March 31, 2025

## Lathe Kit with Trolley



### On Car Brake Lathe for Car and Light Truck

SKU OUTSIDE BUY/EPO **15,299<sup>99</sup>** REG. \$16,449.99  
PCTX15-6ADP

- Plug In, Variable Speed 48v DC Motor
- Performance Plus Cutting Head
- New PFM 2.0 Electronics
- Patented One Touch Lateral Run Out (LRO) Compensation
- Cross Platform Compatible Computer and Wiring Harness
- 6 LED On-Board Work Light
- 4 Wheel, 4 Axis, Adjustable Trolley

SAVE **\$1,150**

On-Site Installation and Training Included

Offer Good While Supplies Last Through March 31, 2025

WARRANTY: 2 Year Parts and Labor

### Performance Plus Cutting Tips

SKU OUTSIDE BUY/EPO **109<sup>99</sup>**  
PCT50-778

- Includes: 6 Tips with Screws

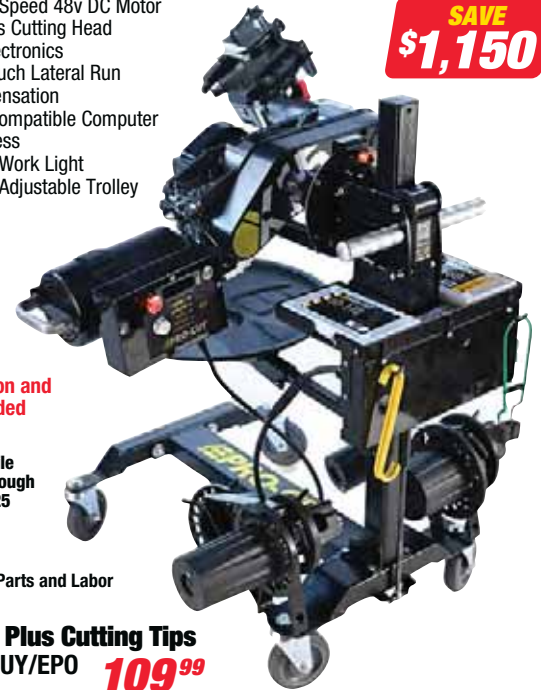

**TEST DRIVE BEFORE YOU PURCHASE!**

**901-300-4878**

## Ranger®

### RL-8500 Combination Brake Lathe with Bench and Standard Tooling

SKU OUTSIDE BUY/EPO **9,199<sup>99</sup>**  
RANRL8500

- Complete Kit Includes Lathe, Standard Adapters and Bench
- Provides a Faster, More Accurate and Easier Resurfacing Capability Than Any Other Brake Lathe in Its Class
- Infinitely Variable Speed Controller Able to Turn Rotors and Drums
- Quick-Change Adapter-Plus System with Built-In Springs Eliminates the Need for Conventional Bell Clamps and Cones
- Independent DC Servo Motors Control the Cross-Feed and Spindle-Feed Drives
- One-Cut Micro Finish
- 150 or 200 RPM Spindle

### RL-8500XLT HD Combination Brake Lathe with Bench and Standard Tooling

SKU OUTSIDE BUY/EPO **10,399<sup>99</sup>**  
RANRL8500XLT

WARRANTY: 1 Year Parts and Labor

Leasing Terms Available, Ask Your AutoZone® Commercial Sales Manager.



RANRL8500

Shown with Optional Equipment. Accessories Not Included.



### Truck Adapter Package

SKU OUTSIDE BUY/EPO **2,599<sup>99</sup>**  
RAN150161

- Super-Duty Truck Tooling Package Consists of an Upgraded 1-7/8" Arbor and a Wide Variety of Adapters
- 32 Piece Set Allows Expanded Coverage to Handle Any Vehicle Up to 1 Ton Trucks
- Fits RL-8500 and RL-8500XLT



Customer Responsible For Offloading, Liftgate Service Available.

For Outside Buy/EPO, Call 901-300-4878



# BRAKE SERVICE

## Brake Bleeding Tools

OEM TOOLS

### Vacuum Pump Tester, Power Steering and Brake Bleeder Kit

SKU 1103570 37070 **39<sup>99</sup>**

- Includes: Vacuum Pump Reservoir Jar with Transfer Lid, Storage Lid, Brake Bleeding Adapter Package, Steering Pump Adapters and Tubing Pump with Vacuum Gauge and Accessories



### 1 Liter Pneumatic Vacuum Brake Bleeder with Refill Bottle

SKU 1282750 22505 **47<sup>99</sup>**

- Convenient Single-Person Operation
- Effective for Use on Disc/Drum Brakes and Clutches
- Auto-Refill Kit to Simplify the Master Cylinder Refill
- Uses a Standard Workshop Air Supply



### Universal Fluid Dispensing Bottle

SKU 568477 24443 **39<sup>99</sup>**

- Refill the Master Cylinder During Vacuum or Manual Hydraulic Brake or Clutch Bleeding and Flushing
- Mounts Securely to Master Cylinder and Clamps
- Capacity: 50 Oz.



**BONUS VALUE: \$9.99**

### Brake Bleeder Wrench (8 and 10 mm)

25317

With Purchase of: 24443

Offer Good While Supplies Last Through March 31, 2025

### 2 Liter Pneumatic Vacuum Brake Bleeder with Refill Bottle

SKU 1361989 22506 **59<sup>99</sup>** REG. \$69.99

- For Use on Brakes and Hydraulic Clutches
- Convenient Single-Person Operation
- Uses Standard Workshop Air Supply
- Includes: Auto-Refill Kit to Simplify the Master Cylinder Refill and Adapters to Fit Most US and Domestic Vehicles
- Standard and ABS Brake Systems

**SAVE \$10**



### DIY Reverse Brake and Clutch Bleeder

SKU 459112 PHO2104-B **64<sup>99</sup>**

- Easily Bleeds ABS
- Removes Trapped Air
- Attachments to Fit All Vehicles



### V-12 Economy Professional Reverse Brake and Clutch Bleeder

SKU 289898 PHO2003 **199<sup>99</sup>**

- Bleed the Brakes on Any Vehicle in 10 Minutes or Less, Including ABS
- Save Time and Money on Good Parts Not Properly Bled
- One Man Operation



Offer Good While Supplies Last Through March 31, 2025

### 1.3 Quart Vacuum Brake Bleeder

SKU 459166 MITMV6870 **139<sup>99</sup>**

- 1.3 Quart Reservoir
- Applications: Brake Bleeding, Hydraulic Clutch Bleeding
- Universal Bleed Screw Adapter Fits Most Common Sizes
- Includes Two Replacement Bleed Screw Adapters



### Silverline Elite Test Kit

SKU 988888 MITMV8500 **139<sup>99</sup>**

- Provides Either Vacuum or Pressure with Equal Precision and Convenience
- Performs Engine Performance Diagnostics, Brake Bleeding, Fluid Transfer, Evacuation, Sampling and More
- Includes Components Needed to Perform Hundreds of Diagnostic and Mechanical Tests



### Brake Bleeding Kit

SKU 604208 MITMV6830 **229<sup>99</sup>**

- Compressed Air Operation
- 1.9 Quart Capacity
- Swivel Air Inlet with Quick Disconnect



### Pressure Brake Bleeding System

SKU 383099 MITMV6840 **499<sup>99</sup>**

- Large 1.2 Gallon Capacity Dispenser
- Includes 7 Master Cylinder Adapters That Connect to Most U.S., Asian and European Cars and Light Trucks
- Pressure Gauge Indicates Dispensing Pressure
- Utilizes Push-to-Connect, Quick-Change Adapters
- Integrated Manual Relief Valve for Safety



### 2.5 L Pressure Brake Bleed Kit

SKU 1361996 MITMV7840 **549<sup>99</sup>**

- Utilizes Shop-Air to Produce Pressure for Dispensing and Vacuum for Extracting
- Pressure Control System Safely Maintains Output Pressure Between 20 and 25 psi
- Includes 7 Master Cylinder Adapters That Connect to Most Domestic and Import Cars and Light Trucks
- Conveniently Located On/Off and Flow Control Valve



### 5 Piece Brake Bleeder Wrench Set

SKU 1442597 VIMBB500 **59<sup>99</sup>**

- Includes: 7 mm to 11 mm
- True Size Hex Openings for Tight Fit
- Satin Chrome Plated High Alloy Steel
- Angles are Designed to Access Bleeder Screws without Removing the Wheel

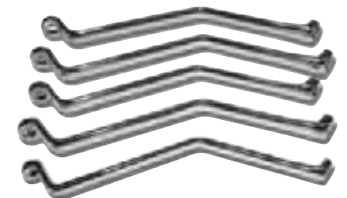

# BRAKE SERVICE

TO ORDER, contact your Commercial Sales Manager or go to [AutoZonePro.com](http://AutoZonePro.com)

BRAKE SERVICE

## Disc Brake Tools

OEM TOOLS®

### 18 Piece Disc Brake Caliper Set

SKU 94798 **42<sup>99</sup>**  
27113

- Includes Caliper Adapters from 1-3/16" to 2-1/2" – Some Specifically to Service Nissan, Saab and Honda Models
- Includes Right and Left Hand Caliper Rotation Tools
- Left Hand Thread is Useful When Working on 2004-2007 Ford Freestyle, 500, 2008 Taurus and Taurus X Models
- Rust Resistant Finish



### 37 Piece Disc Brake Service Kit

SKU 1125858  
25107

- Includes: Disc Brake Caliper Tool Set, Pad Spreader, Brake Caliper Brush, 8 Brake Caliper Hangers, 3 Bleeder Wrenches and One-Man Brake Bleeder Kit



OEM TOOLS®

**69<sup>99</sup>**

REG. \$156.92

**SAVE \$86**

When You Buy the Kit

### Pneumatic Brake Caliper Tool Set

SKU 1053954 **219<sup>99</sup>**  
MSC43050

- Durable Non-Impact Single Piston Shaft
- O-Ring Protected Shaft to Maintain Proper Pressure
- Magnetic Base to Secure Press Adapters
- 15 Piece Press Adapter Set



Mastercool®  
"World Class Quality"

### Dual Piston Press

SKU 900811 **54<sup>99</sup>**  
25741

- Designed to Press-In Single and Dual Piston Brake Calipers
- Universal Application on Cars, Light and Heavy Trucks
- Rugged Design for Longer Tool Life



OEM TOOLS®

### Dual Speedy Pad Spreader

SKU 291420 **84<sup>99</sup>**  
LIS25750

- Compresses Dual Brake Pistons Simultaneously
- Makes Dual Piston Pad Replacement a Simple Job



Lisle®

### Speedy Pad Spreader

SKU 291417 **64<sup>99</sup>**  
LIS24300

- Compresses Disc Brake Pistons in Seconds
- Makes Brake Pad Replacement Easier



Lisle®

### Quick Quad Pad Spreader

SKU 080553 **99<sup>99</sup>**  
LIS29100

- A Quick Way to Spread Brake Pads and Compress Disc Brake Pistons for Pad Replacement on Single, Double and Quad Piston Calipers
- Simultaneously Compress All 4 Pistons on Quad Piston Applications
- Can Be Used While Caliper is on the Vehicle or Hanging Free



Lisle®

### Brake Caliper Press (Standard Size)

SKU 954224 **99<sup>99</sup>**  
LNG279

- Size Range is 1.7" to 3"
- Works on Various Single, Dual and Quad Piston Calipers
- 360° Ratchet Swing Allows Access at Any Angle



LANG

### Brake Caliper Press (Small Size)

SKU 1400043 **89<sup>99</sup>**  
LNG277

- Size Range is 1" to 2.25"

### Brake Caliper Piston Rewind Tool

SKU 1368620 **44<sup>99</sup>**  
35058 REG. \$54.99

- Includes a Standard Two-Pin Adapter Compatible with Any Piston Adapter
- Includes a Fully Adjustable 3/8" Drive 2 and 3 Pin Adapter Tool That Fits Most Vehicles
- Powerful Internal Spring to Apply Stable Pressure to the Caliper Piston

**SAVE \$10**



OEM TOOLS®

Offer Good While Supplies Last Through March 31, 2025

### Brake Hub Resurfacing Tool

SKU 013590 **15<sup>99</sup>**  
24686

- Quickly Remove Rust on Lug Studs and Rotors on the Hub Assembly
- Use with Drill for a Quick and Easy Job
- Fits All Passenger Cars, Light Trucks and SUVs
- Includes 4 Pads



OEM TOOLS®

**BONUS VALUE: \$19.99**

### Large Replacement Pads - 5 Pack

65688

- Replacement Brake Hub Resurfacing Pads for 24686 Includes (5) 2" Pads



With Purchase of: 24686

Offer Good Through March 31, 2025

### 2 and 3 Pin Brake Rewind Tool

SKU 13592 **24<sup>99</sup>**  
24693

- 2 Fully Adjustable to Fit Thousands of Vehicles
- No Need for Multiple Tools
- 3/8" Drive Adapters



3 Pin Side

2 Pin Side

Prices subject to change without notice. Prices do not include applicable taxes, vehicles, tires, rims, installation or optional equipment as shown. Please do not return purchases to the store. For information regarding warranty, repair, or any questions or concerns, call 901-300-4878.

AZG0125

111

# BRAKE SERVICE

## Sprayers

### Red Powder Coated Aluminum Sprayer

SKU 186463  
MSMB8000PL **46<sup>99</sup>**

- 16 Oz. Capacity
- Not for Use with Chlorinated Solvents
- Pressurize Up to 200 psi

### Complete Repair Kit for B8000PL

SKU 186467  
MSMBK50 **29<sup>99</sup>**



### Red Powder Coated Steel Sprayer

SKU 186459  
MSMA1000R **79<sup>99</sup>**

- 32 Oz. Capacity
- Not for Use with Water-Based Products
- Pressurize Up to 200 psi



### Repair Kit

SKU 186465  
MSMK10 **26<sup>99</sup>**

- Used for MSMA1000R
- Includes All Parts That Can Be Replaced
- All Chemical Resistant Seals



### Filler Cap Assembly

SKU 186466  
MSMP156 **26<sup>99</sup>**

- For Model "A" Sprayers
- Hand Removable

## Hones and Stones

### Rotor Flex-Hone®

**64<sup>99</sup>** each

- Lowers Harmonic Vibrations
- Ideal for New and Resurfaced Rotors and Flywheels

#### Fine

SKU 341310  
BRMRMFH240Z25

#### Medium

SKU 341298  
BRMRMFH120Z25

#### Coarse

SKU 341314  
BRMRMFH60Z25



### Adjustable Disc Brake or Small Engine Hone

SKU 531707  
25030 **15<sup>99</sup>**

- Includes 3 Medium (220) Grit 3/4" Stones



## Brake Fluid Testers

### Brake Strip + 100 Ct. Coolant Strip Double Ended with Customer Cards

SKU 1089037  
PHO3006-PLUS **89<sup>99</sup>**

- Double Ended Test Strips for Brake Fluid and Coolant
- Use on DOT 3 or 4 Brake Fluid
- Compatible with All Coolant Colors
- Includes: 100 Double Ended Strips and 100 Rating Scale Cards



### Double Ended Brake Fluid + Coolant Test Strips, 100 Ct.

SKU 666577  
PHO3001-PLUS **84<sup>99</sup>**



### BrakeStrip Brake Fluid Copper Test Kit

SKU 289905  
PHO3006 **79<sup>99</sup>**

- Everything Needed to Test Brake Fluid
- Know within 60 Seconds if it's Time for a Change
- Includes: 1 Tube of 100 Test Strips and 100 Color Pop Rating Cards



### Brake Fluid Tester - DOT 3, DOT 4, DOT 5.1

SKU 850067  
25269 **27<sup>99</sup>**

**Built-In LED Light to Ensure Tips are in Proper Contact with Fluid**

- Easily, Quickly and Precisely Checks the Water Content of 8 Types of Polyglycol-Based Brake Fluids (DOT 3, DOT 4, DOT 5.1, ACDelco DOT 3, Pennzoil, Prestone, Motorcraft and Toyota DOT 3)



### Electronic Brake Fluid Tester

SKU 191687  
25267 **19<sup>99</sup>**

- Checks Moisture Content in Any Brake Fluid
- Multi-Colored LED Panel for Easy Recognition
- Automatic Shut-Off
- Calibrated for DOT 4 Fluid
- 1 AAA Battery Included



## Fluid Exchanger

### Premium Brake Fluid Exchange System

SKU 1407509  
MVC500-8100

**3,479<sup>99</sup>**

- Includes Brake Adapter Kit
- Pressure and Vacuum Assist
- Portable - Operates on 12 Volt DC
- Complete Brake System Exchange in 10 Minutes
- Adjustable Pressure Regulator Controls Operating Pressure
- Performs Brake Flush Using Pressure and Vacuum Simultaneously



## Brake Service Tool

### Heavy Duty Hub Drum and Rotor Puller Kit

SKU 1125878  
25106 **139<sup>99</sup>**

**Use with Impact Wrench to Remove Hubs, Drums and Brake Rotors**

- Includes 3 Hub Adapters for Use with Most Common Hub Sizes and Types
- Jaw Spread Up to 12-3/4" with 5" Reach
- Durable Forged Frame Rated to 7 Tons of Pulling Force for the Toughest Jobs
- Drum and Rotor Pulling Arms Feature with Raised Stops for Use with Ratchet Straps (Not Included)
- Easily Adjust the Arms and Set Puller in Place for Tough Pulling Jobs in Tight Spaces
- Includes: Sturdy Blow Mold Case





## Scan Tools

### TEXA Diagnostic Kits

**NEW**

TEXA

- World Class US-Based Support, with the Most Complete Vehicle Coverage
- Lifetime Repair or Replacement Equipment Warranty with Current Software Subscription
- Continual Updates on All Makes and Models with Current Software Subscription

- Fast, Powerful Hardware for Maximum Shop Efficiency
- Wiring Diagrams, Repair Procedures, Dashboards, Advanced Resets, Activations and More

#### Axone Light Truck Diagnostic Kit

SKU OUTSIDE BUY/EPO **5,999<sup>99</sup>**  
TEXAXLTHDTRK

- Advanced Diagnostics and OE-Level Coverage for Heavy-Duty Truck, Trailer, and Light Commercial Vehicles
- Includes: AXONE NEMO LIGHT, Suitable for a Large Range Of Environments and the TXT Multihub



#### Axone Plus Truck Diagnostic Kit

SKU OUTSIDE BUY/EPO **7,499<sup>99</sup>**  
TEXAXPLHDTRK

- Advanced Diagnostics and OE-Level Coverage for Heavy-Duty Truck, Trailer, and Light Commercial Vehicles
- Includes: AXONE NEMO PLUS, Suitable for a Large Range Of Environments and the TXT Multihub



#### Axone Plus Master Fleet Package for Truck/OHW/Car

SKU OUTSIDE BUY/EPO **11,999<sup>99</sup>**  
TEXAXPLMFP

- Provides Advanced Diagnostics and OE-Level Coverage for Diverse Fleets Including Car, Truck, Agriculture and Construction Equipment
- Includes: AXONE NEMO PLUS, Suitable for a Large Range Of Environments, the TXT Multihub and the Off-Highway Essential Cable Case



For Outside Buy/EPO, Call 901-300-4878

## Smoke Leak Detector



### Dual Evap Smoke Machine\*

SKU OUTSIDE BUY/EPO **1,649<sup>99</sup>**  
MSC43065

- For Evap, Turbo/Intake and Heavy Duty Truck Testing\*
- For Evap and High Pressure Diagnostic Testing
- Multiple Options for Smoke Injection Include Built-In Internal Compressor, Shop Air and Inert Gases
- Accessories Include: Smoke Hose, Block Off Caps, Exhaust Cone, Schrader Valve Remover/Installer, Evap Service Port Adapter Hose, Smoke Illuminating Flashlight, Smoke Producing Fluid and Bladder



\* Heavy Duty Truck Testing Requires MSC43062 Adapter Kit, Not Included (Sold Separately)

## Cooling System



### Heavy Duty Cooling Kit

SKU 954231 **479<sup>99</sup>**  
MSC43306

- Includes Heavy Duty Vehicle Adapters, Pressure Test Regulator, Vacuum Refill Attachment with Tubing in a Plastic Case
- For Use with Freightliner, International, Kenworth, Peterbilt, Mack, Volvo, GMC and Sterling Cooling Systems
- Uses Shop Air to Pressure Check and Vacuum Refill
- 4 Quick-Disconnect Vacuum Attachments Provide Quick Refilling of the Cooling System and Eradicates Airlocks



## Recovery Machine



### Fully-Automatic Heavy Duty R134a Refrigerant Management System

SKU 1407805 **6,949<sup>99</sup>**  
CPSMXHD

- For Commercial and Heavy Duty Applications
- 6 CFM Dual-Stage Vacuum Pump
- Compressor
- Comes Standard with a 50 Lb. Tank; Upgradeable to 90 Lb.
- Wi-Fi and Bluetooth Enabled



# HEAVY DUTY

## Specialty Tools

### NAVISTAR® MAXXFORCE® Fuel Line Disconnect Tool Set - 4 Piece

SKU 004112 **34<sup>99</sup>**  
25031

- For Series 11 and 13 Engines
- Sized to Depress Fuel Release Tabs for Efficient Fuel Line Removal
- 1 Straight and (1) 90° Tool for 11.8 mm Fuel Lines; 1 Straight and (1) 90° Tool for 16 mm Fuel Lines



### Heavy Duty U-Joint Puller

SKU 041474 **124<sup>99</sup>**  
24538

- Easily Removes Seized U-Joint Cups on Most Class 7 and 8 Trucks
- Safely Disassemble Drivelines without Hammering or Heating Components
- Does Not Damage the Driveshaft, Yokes, Joints or Bearing Cups
- Bearing Cup Outside Diameter: 1.5" to 2.2"



### Automatic Slack Adjuster Release Tool and Wrench

SKU 1207889 **24<sup>99</sup>**  
25252

- 5/16" Double Square Ratchet Has an Angled Head to Give Extra Clearance for Hands
- Side-Mounted Forward/Reverse Lever for Easy Operation
- Speeds Up Installation on Meritor® Heavy Duty Truck Brake Slack Adjusters to Simplify Brake Service



### Brake Anchor Pin Press

OEM TOOLS®

SKU 1361998 **124<sup>99</sup>**  
27090

- For Removal of Brake Anchor Pins and Bushings on 16-1/2" S-Cam Trailer and Tractor Q Brake Systems
- No Need to Remove the Hub or Dust Shield
- Rigid C-Frame with 10 Ton Capacity
- Manufactured from High Grade Steel for Strength and Durability
- Manual, No Hydraulics Required



## Heavy Duty Wheel and Tire Service

### Heavy Duty Truck Tire Changer

SKU OUTSIDE BUY/EPO **16,549<sup>99</sup>**  
ROTR511

- Designed to Fit Trucks, Buses, Agriculture Applications and Super Single Tires
- Handle Wheels from 10" to 26", 12" to 28", 14" to 30"
- Locking System Suitable for Reverse Rims
- Quick Locking Wheel Centering Adapter
- Full Range of Bead Clamps and Adapter
- Easy Roller Bead-Breaking Feature
- Max. Tire Diameter: 45"
- 220V, 1Ph



**INCLUDES: Set Up and Training**

WARRANTY: 3 Years Parts and Labor

### Heavy Duty Wheel Balancer

SKU OUTSIDE BUY/EPO **10,749<sup>99</sup>**  
ROTR540

- Designed to Fit Commercial Truck, Light Truck and Passenger Vehicles
- Balance Compact Cars to HD Trucks
- Auto Stop on Top for Weight Position
- Auto Entry of Distance and Diameter
- Integrated Wheel Lift Up to 441 Lb.
- Max. Rim Diameter: 30"
- Max. Tire Diameter: 51"



**INCLUDES: Set Up and Training**

WARRANTY: 3 Years Parts and Labor

### Coats® CHD-6330 Heavy Duty Tire Changer

SKU OUTSIDE BUY/EPO **20,499<sup>99</sup>**  
AMM8006330

- Motor: 2 HP
- Max. Tire Diameter: 63"
- Rim Diameter: 13" to 27"
- 4-Jaw Chuck Allows for Fast and Easy Clamping of Virtually All Rim Styles
- Features Portable Control Station
- Solid, Single Piece Frame for Added Capacity and Dependability



**INCLUDES: Manufacturer's Set Up**

WARRANTY: 1 Year Parts and 6 Months Labor

### Coats® 6450-3D Heavy Duty Balancer

SKU OUTSIDE BUY/EPO **18,449<sup>99</sup>**  
AMM64503DKT1P

**Kit Includes Wheel Lift Plus Lug and Hub Centered Budd Style Adapters**

- Dual Calibration Software Stores and Runs Two Independent Sets of Calibrations
- Powerful 1.5 HP Direct Drive Motor Shaves 20 Seconds Off of a Typical 22.5" Spin
- Designed for High Volume Balancing, the Perfect Machine for Delivery Vehicles and Tractor Trailers
- Max. Tire Diameter: 52"
- Max. Tire Weight: 500 Lb.



**INCLUDES: Manufacturer's Set Up**

WARRANTY: 1 Year Parts and 6 Months Labor



Customer Responsible For Offloading, Liftgate Service Available.

For Outside Buy/EPO, Call 901-300-4878

## Low Profile Oil Drains

### 17 Gallon Low Profile Truck Drain

SKU 526486 **449<sup>99</sup>**  
LIN3665

- 6' Hose Extends from the Bottom of the Reservoir and Can Be Connected to a Pump to Evacuate Fluid from the Drain



LINCOLN®

## Truck Tire Tools

### Tubeless Truck Tire Iron

SKU 394384 **99<sup>99</sup>**  
KTL34645

**Includes: 1 Tire Iron**

- Tip Ends Insert Easily and Will Not Cut or Rip Bead or Sidewall
- Length: 37"
- Stock Diameter: 3/4"

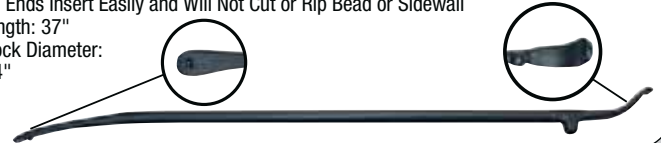

Ken-Tool®  
WHEREVER TIRES ARE CHANGED™

• Free Delivery in 48 Continental United States • Specifications Subject to Change without Notice or Liability • Equipment Lead Times and Shipping May Vary • Customers Responsible for Offloading Equipment Upon Arrival • Leasing Terms Available. Ask Your AutoZone® Commercial Sales Manager.

# HEAVY DUTY

FOR HELP with Selection, Confirm Availability and Ordering Instructions, Call 901-300-4878

HEAVY DUTY

## Heavy Duty Lifts

**CL Challenger Lifts**

### 56,000 Lb. Mobile Lift System/Set of 4

SKU OUTSIDE BUY/EPO  
CHLCLHM-140-4

**47,999<sup>99</sup>**

- 110 Volt Charging System
- Completely Wireless System
- Adjustable Wheel Carriage Adapts from 5" to 24.5"
- Integrated Touch-Screen Control Console at Each Column Allows Operation from Any Unit
- 14,000 Lb. Capacity per Column

Includes: Batteries, Fluids and Factory Training



### 27,000 Lb. Heavy Duty Truck Lift

SKU OUTSIDE BUY/EPO  
BENHDS27

**24,299<sup>99</sup>**

- Runways Include Rail-Kit for Optional Accessories
- Runways Adjust for Different Tread Widths
- Electric/Hydraulic Power System
- Fully Enclosed Lifting Cables, Safety Locks and Sheaves
- Pneumatic Push-Button Safety Release
- Length: 297"

WARRANTY: 1 Year Parts and Labor



Customer Responsible For Offloading.

For Outside Buy/EPO, Call 901-300-4878

## Lifting Equipment

### 6,000 Lb. Heavy Duty Engine Crane

SKU 1267948  
AFF3584

**1,399<sup>99</sup>**

- 4 Different Boom Settings: 3, 2, 1.5 and 1 Ton
- Rear of Crane: 61.5" Tall and 33" Wide
- Distance Between Front of Legs: Retracted 23", Extended 28.5"



### 35 Ton Air Hydraulic Axle Jack

SKU 954200  
AFF536

**1,749<sup>99</sup>**

- Unique Motor Design Advances Ram to Load Faster
- Air Assisted Lowering and Dual Return Springs Provide Controlled and Easy Descent
- Safety Overload System Prevents Jack from Being Used Beyond its Rated Capacity
- Corrosion Resistant Aluminum and Nylon Composite Air Motor



## Locknut Sockets

OEM TOOLS

### 7 Piece Wheel Bearing Locknut Set

SKU 1207886  
37385

**114<sup>99</sup>**

- Includes: 55 mm 6PT, 2-3/8" 6R, 2-3/8" 6PT, 2-1/2" 6R, 2-1/2" 6PT, 2-9/16" 6R and 2-3/4" 6R
- Comes with Standard Hex (6PT) and Rounded (6R) Hex Sockets to Fit Many Applications
- For Use with 1/2" Square Drive Ratchet, Breaker Bar or Torque Wrench



### 5 Piece Budd Wheel Socket Set

SKU 1207878  
37384

**119<sup>99</sup>** REG. \$139.99

- 35 mm, 38 mm, 41 mm and 1-1/2" Sockets Feature a Dual Socket Design with a Hex to Remove the Lug Nut and an Internal Square Drive to Remove the Inside Wheel
- 38 mm, 41 mm and 1-1/2" Sockets Each Have a 13/16" Internal Square
- 35 mm Socket Has a 11/16" Internal Square
- For Use with 1" Drive Ratchet, Breaker Bar, Torque Wrench and Impact Wrench



SAVE \$20

Offer Good While Supplies Last Through March 31, 2025

### Truck Axle Wheel Bearing Sockets

- 3/4" Square Drive
- Constructed with High-Grade Steel for Strength



#### 4", 6 Pt.

SKU 466541  
25482

**34<sup>99</sup>**

#### 2-9/16", 8 Pt.

SKU 466534  
25473

**29<sup>99</sup>**

#### 4-1/8", 6 Pt.

SKU 265085  
25483

**39<sup>99</sup>**

#### 4-3/8", 8 Pt.

SKU 466543  
25485

**44<sup>99</sup>**

## Heavy Duty Stands

OEM TOOLS

### 22 Ton Heavy Duty Axle Stands (Pair)

SKU 757098  
24854

**179<sup>99</sup>**

- Min. Height: 12-1/4"
- Max. Height: 19-3/4"
- Adjustable Pin Design
- Features Handle for Transport and Positioning
- Large V-Shaped Saddles Center Lift Points for Secure Placement



## Heavy Duty Truck Oil Filter Wrenches

OEM TOOLS

### Small

SKU 344322  
25231

**19<sup>99</sup>**

- Range: 4-1/8" to 4-5/8" (104 to 118 mm)

### Medium

SKU 344323  
25232

**19<sup>99</sup>**

- Range: 4-5/8" to 5-1/4" (118 to 134 mm)

### Large

SKU 344324  
25233

**21<sup>99</sup>**

- Range: 5-1/4" to 5-3/4" (134 to 142 mm)



- Free Delivery in 48 Continental United States
- Specifications Subject to Change without Notice or Liability
- Equipment Lead Times and Shipping May Vary
- Customers Responsible for Offloading Equipment Upon Arrival
- Leasing Terms Available. Ask Your AutoZone® Commercial Sales Manager.

Prices subject to change without notice. Prices do not include applicable taxes, vehicles, tires, rims, installation or optional equipment as shown. Please do not return purchases to the store. For information regarding warranty, repair, or any questions or concerns, call 901-300-4878.

AZG0125

115

# TOOL STORAGE



- 24" Deep Drawers
- 100/200 Lb. Drawer Capacity
- Non-Slip PVC Drawer Liners
- UV Protected Finish
- Constructed with 16 G Steel Frame
- Lift Latch Drawer Pulls

ALSO AVAILABLE IN



**Homak**



**72" 16 Drawer Rolling Cabinet with Stainless Steel Top – Green**

SKU 1267935  
HOM72RSPRCSG

**1,799<sup>99</sup>**

• 72"(W) x 24"(D) x 40"(H)



**54" 10 Drawer Rolling Cabinet with Stainless Steel Top – Blue**

SKU 1343816  
HOM54RSCABSBL

**1,799<sup>99</sup>**

• 54.5"(W) x 24"(D) x 40.375"(H)



**72" 3 Drawer Hutch – Black**

SKU OUTSIDE BUY/EPO  
HOM72RSPHUTBK

**1,599<sup>99</sup>**

• 71.5"(W) x 23.5"(D) x 24.375"(H)



**54" Top Hutch – Blue**

SKU 1343820  
HOM54RSPHUTBL

**1,099<sup>99</sup>**

• 54"(W) x 23.5"(D) x 24.375"(H)



**72" 12 Drawer Top Chest – Blue**

SKU OUTSIDE BUY/EPO  
HOM72RSPCHSTOBL

**1,699<sup>99</sup>**

• 72"(W) x 23.5"(D) x 21.375"(H)



**54" 8 Drawer Top Chest – Black**

SKU OUTSIDE BUY/EPO  
HOM54RSCHSTBK

**1,199<sup>99</sup>**

• 54"(W) x 23.5"(D) x 21.375"(H)

**72" 16 Drawer Roller Cabinet – Blue**

SKU OUTSIDE BUY/EPO  
HOM72RSPRCBBL

**2,419<sup>99</sup>**

• 72"(W) x 24"(D) x 39.25"(H)

**54" 10 Drawer Rolling Cabinet – Black**

SKU OUTSIDE BUY/EPO  
HOM54RSPCABBK

**1,699<sup>99</sup>**

• 54.5"(W) x 24"(D) x 40.375"(H)



Customer Responsible For Offloading, Liftgate Service Available.

For Outside Buy/EPO, Call 901-300-4878

- Free Delivery in 48 Continental United States
- Specifications Subject to Change without Notice or Liability
- Equipment Lead Times and Shipping May Vary
- Customers Responsible for Offloading Equipment Upon Arrival
- Leasing Terms Available, Ask Your AutoZone® Commercial Sales Manager.

# TOOL STORAGE

FOR HELP with Selection, Confirm Availability and Ordering Instructions, Call 901-300-4878

TOOL STORAGE



- 24" Deep Drawers
- 100/200 Lb. Drawer Capacity
- Non-Slip PVC Drawer Liners
- UV Protected Finish
- Constructed with 16 G Steel Frame
- Lift Latch Drawer Pulls

ALSO AVAILABLE IN



### 41" Top Hutch - Orange

SKU OUTSIDE BUY/EPO  
HOM41RSPHUTO

**849<sup>99</sup>**

- 40.75"(W) x 23.5"(D) x 24.375"(H)

### 41" 9 Drawer Rolling Cabinet - Orange

SKU OUTSIDE BUY/EPO  
HOM41RSPRCO

**1,249<sup>99</sup>**

- 41"(W) x 24"(D) x 39"(H)



**NEW**

### 35" 7 Drawer Flip-Top Service Cart - White

SKU 1343819  
HOM35FTSCWH

**899<sup>99</sup>**

- 31"(W) x 22.5"(D) x 38.875"(H)



### 35" Professional 4 Drawer Flip Top Service Cart - Red

SKU 1343822  
HOM35PSCR

**599<sup>99</sup>**

- 35"(W) x 20.5"(D) x 39.375"(H)



### 35" 4 Drawer Slide Top Cart - Blue

SKU 1343821  
HOM35STCBL

**599<sup>99</sup>**

- 35"(W) x 20.625"(D) x 42"(H)

### 32" Professional 1 Drawer Service Cart - Blue

SKU 1343817  
HOM32PSCBL

**399<sup>99</sup>**

- 31.5"(W) x 17.5"(D) x 35.625"(H)



### 34" Professional 3 Drawer Service Cart - Black

SKU 1267944  
HOM34PSCBK

**649<sup>99</sup>**

- 34.5"(W) x 16.75"(D) x 39.38"(H)

### Professional Plastic Service Cart

SKU 1414408  
HOMPP06032031

**249<sup>99</sup>**

- Four 4" x 1" Swivel Casters
- Load Capacity Up to 300 Lb.
- Tray-to-Tray Distance of 16.1" for Maximum Storage



Customer Responsible For Offloading, Liftgate Service Available.

For Outside Buy/EPO, Call 901-300-4878

- Free Delivery in 48 Continental United States
- Specifications Subject to Change without Notice or Liability
- Equipment Lead Times and Shipping May Vary
- Customers Responsible for Offloading Equipment Upon Arrival
- Leasing Terms Available, Ask Your AutoZone® Commercial Sales Manager.

Prices subject to change without notice. Prices do not include applicable taxes, vehicles, tires, rims, installation or optional equipment as shown. Please do not return purchases to the store. For information regarding warranty, repair, or any questions or concerns, call 901-300-4878.

AZG0125

117

# TOOL STORAGE

## 44" 8 Drawer Power Service Cart – Gray

SKU 1282738  
HOMRSPRO44G **1,299<sup>99</sup>**

- Top Till Includes Full-Extension Gas Struts and a Lockable Security Compartment with an Additional Power Strip to Store and Charge Phones, Laptops and Other Devices
- Equipped with High Security Locking System to Keep Valuables Safe and Secure
- 40.5"(W) x 23.9"(D) x 40.2"(H)

**Features 4 Electric Outlets and 2 USB Ports to Efficiently Charge, Store and Organize Power Tools in One Place**

**Homak**



## 54" 7 Drawer Rolling Workstation - Blue

SKU OUTSIDE BUY/EPO  
HOM54RWSBL **1,264<sup>99</sup> NEW**

- Durable Stainless Steel Work Surface
- Power Tool Drawer with Power Strip Includes 4 Electric Outlets and 2 USB Ports
- Four (4) 5x2 inch Casters with a Weight Capacity of 520 Lb. Each: 2 Swivel Locking and 2 Fixed
- 57.5"(W) x 29"(D) x 41"(H)

For Outside Buy/EPO, Call 901-300-4878

**Homak**



## 72" 31 Drawer Professional Chest and Cabinet Set

SKU 662880  
24741

**4,599<sup>99</sup>** **SAVE \$299**  
When you buy the combo  
Total Loading Capacity: 4,750 Lb.  
Casters Rated to 880 Lb. Each

- Overall Dimensions: 72"(W) x 24"(D) x 67"(H)
- Storage Space: 52,299 Cubic Inches
- Drawer Space: 13,906 Sq. Inches

**OEM TOOLS**



## 57" 22 Drawer Professional Combo

SKU 662893  
24738

**3,599<sup>99</sup>** **SAVE \$199**  
When you buy the combo  
Total Loading Capacity: 2,697 Lb.  
Casters Rated to 880 Lb. Each

- Overall Dimensions: 57"(W) x 24"(D) x 66.5"(H)
- Storage Space: 41,466 Cubic Inches
- Drawer Space: 13,404 Sq. Inches

**OEM TOOLS**



Part #	Description	Dimensions	Storage Space	Price
24740	72" 15 Drawer Professional Chest	72"(W) x 24"(D) x 26"(H)	23,076 Cu. In.	\$2,299.99
24739	72" 16 Drawer Professional Cabinet	72"(W) x 24"(D) x 41"(H)	29,223 Cu. In.	\$2,599.99
	Regular Price			\$4,899.98
24741	<b>COMBO PRICE</b>			<b>\$4,599.99</b>
	<b>SAVINGS</b>			<b>\$299.99</b>

Part #	Description	Dimensions	Storage Space	Price
24737	57" 10 Drawer Professional Chest	57"(W) x 24"(D) x 26"(H)	18,938 Cu. In.	\$1,699.99
24736	57" 12 Drawer Professional Cabinet	57"(W) x 24"(D) x 40.5"(H)	22,528 Cu. In.	\$2,099.99
	Regular Price			\$3,799.98
24738	<b>COMBO PRICE</b>			<b>\$3,599.99</b>
	<b>SAVINGS</b>			<b>\$199.99</b>

## 72" 15 Drawer Professional Chest

SKU 666312  
24740 **2,299<sup>99</sup>**

## 72" 16 Drawer Professional Cabinet

SKU 662767  
24739 **2,599<sup>99</sup>**

## 57" 10 Drawer Professional Chest

SKU 666333  
24737 **1,199<sup>99</sup>**

## 57" 12 Drawer Professional Cabinet

SKU 666300  
24736 **1,499<sup>99</sup>**

## 36" Slide Top 3 Drawer Tool Cart - Green

SKU 666298  
24731 **699<sup>99</sup>** REG. \$749.99

**SAVE \$50**

- Constructed with a 19 Gauge Steel Shell and 21 Gauge Steel Drawers
- Full Length Anodized Aluminum Drawer Pull
- Shallow Drawer Dimensions: 30"(W) x 18"(D) x 2.9"(H)
- Deep Drawer Dimensions: 30"(W) x 18"(D) x 6.1"(H)
- Overall Dimensions: 36"(W) x 21"(D) x 46"(H)

Offer Good Through March 31, 2025

**OEM TOOLS**



Access Your Most Used Tools with an OEMTOOLS Slide Top Tool Cart

## Service Cart with Locking Lid and Drawer

SKU 512948  
24961 **159<sup>99</sup>** REG. \$249.99

**SAVE \$90**

- Total Load Capacity: 350 Lb.
- Drawer Loading Capacity of 75 Lb.
- Easy to Maneuver with 4 Swivel Casters: 2 Standard and 2 Locking
- Stays Securely in Place with 2 Locking Casters
- Durable Powder Coated Finish
- Raise-and-Release Safety Drawer Latches to Prevent Drawer from Drifting Open
- Dimensions: 36"(H) x 18"(D) x 30"(L)

Offer Good Through March 31, 2025

**OEM TOOLS**



Customer Responsible For Offloading, Liftgate Service Available.

- Free Delivery in 48 Continental United States • Specifications Subject to Change without Notice or Liability • Equipment Lead Times and Shipping May Vary
- Customers Responsible for Offloading Equipment Upon Arrival • Leasing Terms Available, Ask Your AutoZone® Commercial Sales Manager.

# TOOL STORAGE

FOR HELP with Selection, Confirm Availability and Ordering Instructions, Call 901-300-4878

TOOL STORAGE

## 72" Stainless Steel 11 Drawer Cabinet and Upper Cabinet

SKU 1168659  
OEM24615

**1,599<sup>99</sup>**

### Features:

- Dimensions: 72"(W) x 18"(D) x 71.5"(H)
- Upper Cabinet is 12"(H) x 18"(D)
- Drawer Liners Included



OEM TOOLS®

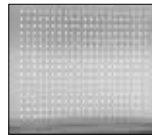

18" Tall Pegboard



Full Extension 100 Lb. Capacity Slides



Heavy Duty Casters 5" x 2"



PVC Coated MDF Top

**BONUS VALUE: \$159.99**

**Service Cart with Locking Lid and Drawer**  
24961



With Purchase of:  
OEM24615

Offer Good While Supplies Last  
Through March 31, 2025

## Steel Workbenches

- Black Powder Coat Finish
- Engineered for Quick Assembly
- Built-In Leg Levelers

### 59" Steel Workbench

SKU 1392321  
HOMGW00550150

**479<sup>99</sup>**

- Weight Capacity: 880 Lb.



### 79" Steel Workbench with 3 Drawers and Wood Top

SKU 1392314  
HOMGS00579030

**599<sup>99</sup>**

- 1.5" Wood Work Surface with Top Mat
- Weight Capacity: 440 Lb.



Howak

### 59" Steel Workbench with 2 Drawers

SKU 1392318  
HOMGW00550170

**629<sup>99</sup>**

- High Security Tubular Lock System
- Ball-Bearing Drawer Slides
- Weight Capacity: 1100 Lb.



### 79" Steel Workbench with 3 Drawers

SKU 1392331  
HOMGW00550160

**799<sup>99</sup>**

- High Security Tubular Lock System
- Ball-Bearing Drawer Slides
- Weight Capacity: 1100 Lb.



## Tear Down Tray



### Adjustable Mobile Work Table 200 Lb. Capacity

SKU 1485038  
VIK52200

**164<sup>99</sup>**

- Adjustable Tray
- Heavy Duty 2" Rubber Composite Swivel Casters
- Multiple Storage Slots, Trays and Insert Grooves Keeps Tools and Parts Organized and Within Reach
- 1" Drawer with Roller Bearing Slides Offer Additional Storage Capacity



Tools Not Included

## Field Boxes

SHEFFIELD®

### XL Field Box

- 4 Locking Options for Security
- Compression Fit Lid with Rubber Gasket for Water and Dust Resistance
- Internal Dimensions: 12-5/8"(L) x 6-5/8"(W) x 8"(H)
- Manufactured with Impact, Abrasion and Crack Resistant Copolymer Plastics
- Food Safe and Resistant to Most Acids and Solvents

#### Olive Drab Green

SKU 989218  
12710

**27<sup>99</sup>**

#### Black

SKU 1392313  
12700

**27<sup>99</sup>**



### XL Field Box with Lift Out Storage Tray

- Lift-Out Tray with 8 Compartments

#### Olive Drab Green

SKU 989216  
12712

**34<sup>99</sup>**

#### Black

SKU 1392328  
12701

**34<sup>99</sup>**

#### White

SKU 1392312  
12721

**34<sup>99</sup>**



## Gear Bag



### All-Purpose Gear Bag

SKU OUTSIDE BUY/EPO  
CLC1111

**74<sup>99</sup>**

- Perfect for Carrying Power Tools, Extension Cords, etc.
- Outside Pockets Hold Small Tools or Accessories
- Abrasion-Resistant Rubber Feet
- Reinforced Padded Carrying Handles for Comfortable Carrying
- Dimensions: 24"(L) x 12"(W) x 12"(H)



For Outside Buy/EPO,  
Call 901-300-4878

Prices subject to change without notice. Prices do not include applicable taxes, vehicles, tires, rims, installation or optional equipment as shown. Please do not return purchases to the store. For information regarding warranty, repair, or any questions or concerns, call 901-300-4878.

AZG0125

119

# TOOL ORGANIZATION

## 2 Post Socket Trays

### 6 Piece Socket Tray Sets

- Metric Socket Range: 4 mm to 15 mm (1/4" Drive), 6 mm to 20 mm (3/8" Drive), 10 mm to 27 mm (1/2" Drive)
- SAE Socket Range: 1/8" to 5/8" (1/4" Drive), 1/4" to 1" (3/8" Drive), 3/8" to 1-1/4" (1/2" Drive)
- Includes: 6 Trays - 1/4", 3/8" and 1/2" Drive in Both Metric and SAE



Tools Not Included

**Metric** **Black and Green**  
SKU 949573  
22233  
**SAE** **23<sup>99</sup>** REG. \$33.99  
**SAVE \$10**

**Metric** **Black and Orange**  
SKU 1142583  
22418  
**SAE** **23<sup>99</sup>** REG. \$33.99  
**SAVE \$10**

**Metric** **Gray and Red**  
SKU 477209  
22413  
**SAE** **23<sup>99</sup>** REG. \$33.99  
**SAVE \$10**

Offers Good Through March 31, 2025

### 3 Piece Socket Trays

- Includes: 3 Trays - 1/4", 3/8" and 1/2" Drive

**SAE** **Green** SKU 749921  
22207  
**24<sup>99</sup>**

**Metric** **Black** SKU 749937  
22211  
**24<sup>99</sup>**



Tools Not Included

## Magnetic Socket Tray Sets

### 3 Piece Magnetic Socket Tray Set Metric or SAE

- Includes: 3 Trays - 1/4", 3/8" and 1/2" Drive in Metric or SAE



**Blue (Metric)** **Metric**  
SKU 1149155  
22486  
**59<sup>99</sup>**

**Black (Metric)** **Metric**  
SKU 1149156  
22487  
**59<sup>99</sup>**

**Red (SAE)** **SAE**  
SKU 1149183  
22484  
**59<sup>99</sup>**

**Green (SAE)** **SAE**  
SKU 1149165  
22485  
**59<sup>99</sup>**



OEM TOOLS

### 6 Piece Magnetic Socket Tray Set - Metric and SAE

- Includes: 6 Trays - 1/4", 3/8" and 1/2" Drive in Both Metric and SAE



**Black and Green**  
SKU 1331490  
22488  
**99<sup>99</sup>** **Metric** **SAE**

**Black and Red**  
SKU 1485048  
22460  
**99<sup>99</sup>** **Metric** **SAE**



**Blue and Green** **Metric** **SAE**  
SKU 1392463  
22461  
**99<sup>99</sup>**

**Blue and Red** **Metric** **SAE**  
SKU 1331485  
22489  
**99<sup>99</sup>**

- SAE**
- 1/4" Tray Holds 2 Sets of Sockets 1/8" to 5/8"
  - 3/8" Tray Holds 2 Sets of Sockets 3/8" to 7/8"
  - 1/2" Tray Holds 1 Set of Sockets 3/8" to 1-1/4"

- METRIC**
- 1/4" Tray Holds 2 Sets of Sockets 4 mm to 14 mm
  - 3/8" Tray Holds 2 Sets of Sockets 6 mm to 20 mm
  - 1/2" Tray Holds 1 Set of Sockets 10 mm to 27 mm

Tools Not Included

## Pro Socket Organizers

### Magnetic Socket Tray

SKU 082922  
22389  
**34<sup>99</sup>**

- Store Up to 36 Total Sockets - 1/4", 3/8" and 1/2" Drive
- Removable Back Panel Allows Magnets to Adhere to Any Magnetic Surface

OEM TOOLS

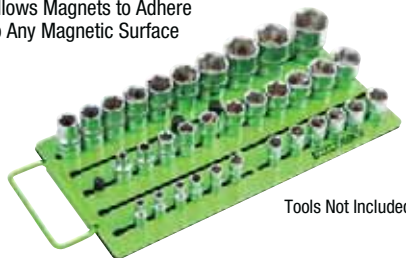

Tools Not Included

## Magnetic Socket Organizers

OEM TOOLS

### Portable Magnetic Socket Organizers

- Holds Up to 28 Sockets
- Powerful Magnets Hold Sockets Securely and Attach Organizer to Any Magnetic Surface
- Low-Profile Design Fits Most Toolbox Drawers



**3/8" Drive**  
SKU 1442590  
23117  
**29<sup>99</sup>**

**1/2" Drive**  
SKU 1414403  
23118  
**29<sup>99</sup>**



Tools Not Included

## Tool Holder

OEM TOOLS

### Magnetic Tool Holder

SKU 749848  
22212  
**31<sup>99</sup>**

- 18" Rail with 16 Sliding Clips
- Multipurpose Clips Hold a Variety of Tools
- Great for Screwdrivers, Ratchets, Wrenches, Pliers and Other Small Tools
- Powerful Magnet for Secure Hold
- Foam Shield to Protect Paint Finishes

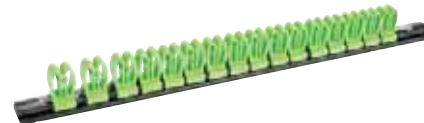



# TOOL ORGANIZATION

TO ORDER, contact your Commercial Sales Manager or go to [AutoZonePro.com](http://AutoZonePro.com)

TOOL ORGANIZATION

## Flexi-Trays

**3 Piece Set**  
SKU 943130  
22217

**59<sup>99</sup>**

- Includes: 10-1/2" x 5-1/4", 10-1/2" x 8-1/2" and 21" x 11-1/2" Trays
- Withstands Motor Oil and Non-Corrosive Fluids
- Anti-Static, Silicone Material Protects Work Surfaces from Damage and Scratching



Tools Not Included

**OEM TOOLS**



UP TO 500° HEAT RESISTANT



## Organizers

**16 Piece Pliers Holder**  
SKU 765589  
22215

**13<sup>99</sup>**

- 16 Extra-Wide Spaces for Pliers with Rubber Grips
- Vinyl Coating for Lasting Dependability
- Dimensions: 14.0" (L) x 5.2" (W) x 2.5" (H)

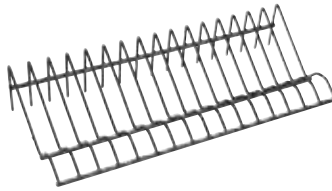

Tools Not Included

## Drawer Organizer Tray

SKU 749932  
22213

**19<sup>99</sup>**

- Rolled Bottom Edges Allow Easy Removal of Small Parts
- Low-Profile Fits in Shallow Toolbox Drawers
- 10-Compartment Tray
- Stackable Design
- Dimensions: 16" (L) x 11" (W) x 1.5" (H)



## Magnetic Trays

### 4 Piece Magnetic Foldable Tray

SKU 1207890  
26052

**24<sup>99</sup>**

- Collapsible Tray Expands from 3/4" to 2" Deep
- Holds Up to 2 Lb.
- Multiple Color Set Keeps You Organized
- Dimensions: 4-1/2" x 4-1/2"



Tools Not Included

**OEM TOOLS**

## Magnetic Bit Holders

### 4 Piece Magnetic Hex Bit Trays

SKU 1284964  
24142

**39<sup>99</sup>**

- Each Tray Holds 36 Hex Bits
- Coated Magnetic Trays Adhere to Most Metal Surfaces



## Magnetic Trays

- Trays Stick to Most Metal Surfaces
- Ideal for Holding Small Parts and Tools
- Heavy Duty Stainless Steel



**5" x 9"**

SKU 965834  
25117C

**14<sup>99</sup>**

- 2 Powerful Magnets with Protective Rubber Coating to Resist Scratching

**10" x 11"**

SKU 965835  
25119

**24<sup>99</sup>**

- 4 Powerful Magnets with Protective Rubber Coating to Resist Scratching



Tools Not Included

## Paper Towel Holder

### Magnetic Paper Towel Holder

SKU 280376  
24952

**17<sup>99</sup>**

- Adjusts to Fit Different Size Rolls
- 3 Rubber-Faced Magnets Won't Scratch Metal Surfaces



Towel Roll Not Included

**OEM TOOLS**

## Wrench Organizers

### 4 Piece Magnetic Wrench Rails

- Holds 40 Wrenches
- Includes: 4 Rails
- Rail Dimensions: 16.6" (L) x 1.9" (H)

**Green**  
SKU 749850  
22217

**21<sup>99</sup>**

**Black**  
SKU 765514  
22219

**21<sup>99</sup>**

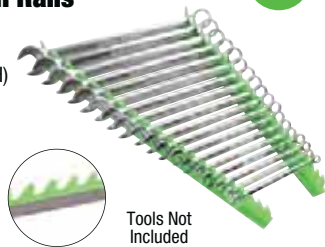

Tools Not Included



### 2 Piece Wrench Organizing Rails - Black

SKU 213161  
22218

**16<sup>99</sup>**

- Holds 35 Wrenches
- Slotted Design Will Fit a Variety of Wrench Types and Sizes
- Rail Dimensions: 23.4" (L) x 1.0" (H)

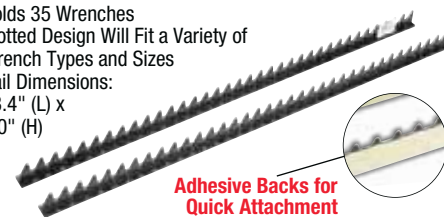

Adhesive Backs for Quick Attachment

### Magnetic Wrench Holder and Organizer

- Holds 10 SAE or Metric Wrenches
- Magnetic Base Attaches to Your Tool Box, Tool Chest, Cart or Metallic Peg Board
- 9-1/4" (L) x 1-1/4" (W) x 2" (D)

**Green**  
SKU 1331491  
22512

**18<sup>99</sup>**



### Magnetic Wrench Organizer

SKU 662782  
22177

**16<sup>99</sup>**

- Organize Up to 12 Wrenches
- Strong Magnets Will Hold Organizer Upright at Full Capacity
- Non-Marring Foam Backing
- Durable Coated Steel Construction



Tools Not Included



### Pro Magnetic Wrench Organizer (Black)

SKU 213098  
22176

**29<sup>99</sup>**

- Organize Up to 12 Wrenches
- Strong Magnets Will Hold Organizer Upright at Full Capacity
- Non-Marring Foam Backing
- Durable Coated Steel Construction



**Black**  
SKU 1331501  
22513

**18<sup>99</sup>**



Tools Not Included

Prices subject to change without notice. Prices do not include applicable taxes, vehicles, tires, rims, installation or optional equipment as shown. Please do not return purchases to the store. For information regarding warranty, repair, or any questions or concerns, call 901-300-4878.

# SHOP EQUIPMENT

## Shop Presses

### 10 Ton Hydraulic Benchtop Shop Press

SKU 666327 **499<sup>99</sup>**  
25088

- Removable Press Cap with 25 mm Hole to Accept OEMTOOLS Press Pin Set (#24813)
- Double Speed Pump Greatly Reduces Set-Up and Press Time
- Movable Press Head for Added Flexibility in Working Position
- Liquid Filled Pressure Gauge

**BONUS VALUE: \$114.99**

#### Shop Press Pin Set

SKU 544794 | 24813

With Purchase of: 25088

- Works with OEMTOOLS 24811, 24812, 25087 and 25088
- Includes: Set of 8 Press Pins, 2-20 Ton Capacity, with Ram Adapter

Offer Good While Supplies Last Through March 31, 2025

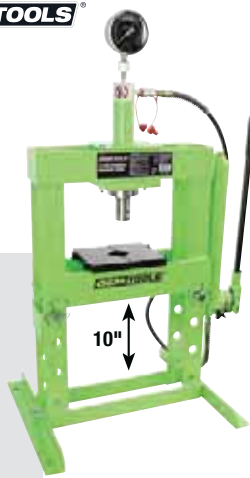

### 20 Ton Air Hydraulic Shop Press

SKU 662928 **799<sup>99</sup>**  
25087

- Removable Press Cap with 25 mm Hole to Accept OEMTOOLS Press Pin Set (#24813)
- Air/Hydraulic Pump Provides Added Versatility
- Double Speed Pump Greatly Reduces Set-Up and Press Time
- Movable Press Head for Flexibility of Working Positions
- Liquid Filled Pressure Gauge for Accurate Pressure Readings
- Durable Powder Coated Steel Frame
- Includes Press Blocks



Liquid Filled Dual Scale Gauge

Removable Press Cap with 25 mm Hole

### 20 Ton Shop Press

SKU 300134 **699<sup>99</sup>**  
24810

- Stronger Compared to Similar Lighter Weight Shop Presses on the Market
- Includes Press Plates
- Remove and Install Bearings, Gears, U-Joints, Bushings, Ball Joints and Pulleys
- Multi-Position Bed for Work Height Adjustment
- Max. Height: 31.5"
- Max. Width: 21.75"

**Super Heavy Duty**



H-Frame Press Weighs Over 250 Lb.



1-3/4" Diameter Ram

Manually Adjustable Table

### 30 Ton Super Duty Shop Press

SKU 954213 **2,349<sup>99</sup>**  
AFF852ASD

- Shatter Resistant Polycarbonate Shield Provides Maximum Protection Against Shrapnel and Debris
- Includes: 2 Piece Press Plate Set and 10 Piece Press Pin Adapter Set
- Glycerin Filled Gauge Accurately Shows Pressing Force
- Double Pump Air Motor for Faster Speeds
- 7 Position Bed Height Configuration



### 50 Ton Super Duty Shop Press

SKU 954201 **3,749<sup>99</sup>**  
AFF854ASD

## Bearing Separators

### 5 Ton Bar-Type Puller/Bearing Separator Set

SKU 347218 **99<sup>99</sup>**  
27236

- Separator Tools are Used with Bar Puller and Legs for a Wide Variety of Pulling Jobs
- Set Includes: 2" and 3" Bearing Splitters, 4 Sets of Hex Push-Puller Legs and a Bar-Type Puller Head with a 9/16" Forcing Screw



### Bearing Splitter 1/4" to 15/16"

SKU 514005 **29<sup>99</sup>**  
27231

- Maximum Spread: 15/16"
- Minimum Spread: 1/4"
- Thread of Tapped Holes in Adapter: 5/16" to 18"
- Distance Between Adjusting Screws: 1-11/16"



### Bearing Splitter 1/2" to 4-5/8"

SKU 514006 **59<sup>99</sup>**  
27232

## Press Support

### Universal Press Support

SKU 804487 **199<sup>99</sup>**  
24809

- Will Make Your Shop Press Safe and Easy to Use
- Supports in 3 Points to Ensure Safe Support without Any Wobbling
- Numerous Holes on Main Block and Swivel Element for Easy Set-Up
- Swivel Element and Removable/Height Adjustable Anvil Bolts Allow Adjustment to Individual Requirements
- Dimensions: 7-3/4" (W) x 9-3/4" (L) x 1-1/2" (H)



## Vises

### 4.5" Light Duty Bench Vise with Swivel Base

SKU 751645 **39<sup>99</sup>**  
24216

- Clamping Strength: 100 Lb.



### 4" Heavy Duty Bench Vise with Swivel Base

SKU 751643 **49<sup>99</sup>**  
24217

- Clamping Strength: 200 Lb.



### 6" Heavy Duty Bench Vise with Swivel Base

SKU 751654 **119<sup>99</sup>**  
24218

- Polished Replaceable Steel Jaws
- Polished Anvil, Permanent Pipe Jaws
- Full 360° Swivel Base
- Clamping Strength: 300 Lb.



### 6-1/2" Professional Workshop Vise

SKU 394648 **399<sup>99</sup>**  
KTL64065

- Jaw Width: 6-1/2"
- Jaw Opening: 9" Replaceable, Reversible Jaws



Prices subject to change without notice. Prices do not include applicable taxes, vehicles, tires, rims, installation or optional equipment as shown. Please do not return purchases to the store. For information regarding warranty, repair, or any questions or concerns, call 901-300-4878.

## Aqueous Parts Washers

OEMTOOLS® aqueous parts washers give you all the cleaning power of a solvent parts washer but use cleaning solutions that are non-toxic and biodegradable. (These washers are not compatible with solvent based solutions.)



### Parts Washers

- Works with Safe Water-Based Cleaning Solutions Only (Not for Use with Solvents)
- 325 GPH Pump
- Includes a Drain Shelf
- Fully Flexible Nozzle
- Tank is Made of Powder-Coated 20 Gauge Steel for Durability and Rust Resistance

#### 3.5 Gallon Bench Top

SKU 300128 24800 **99<sup>99</sup>**

- Dimensions: 18" (L) x 13-1/2" (W) x 9" (H)



#### 20 Gallon Mobile

SKU 750449 24805 **329<sup>99</sup>**

- 4" Casters for Maneuverability
- Drain Tray with 2.9 Gallon Collection Reservoir
- Dimensions: 38" (L) x 21.5" (W) x 37" (H)



#### 20 Gallon

SKU 300117 24801 **299<sup>99</sup>**

- Small Parts Tray
- Dimensions: 31" (L) x 21" (W) x 34.5" (H)



#### 40 Gallon

SKU 300118 24803 **479<sup>99</sup>**

- Small Parts Tray
- Dimensions: 44.75" (L) x 20.5" (W) x 35" (H)



### Pneumatic Heated Parts Washer Cabinet

SKU 1330681 24677 **679<sup>99</sup>**

- Uses Compressed Air to Spray Heated Cleaner for Maximum Cleaning Effectiveness
- Fully Enclosed Chamber Keeps Cleaning Solution and Debris Contained
- Thermostat Controlled Heating Element Heats Cleaning Solution Up to 140°F (60°C)
- Fluorescent Lighting Inside Cabinet Illuminates Work Area
- Built-In Vent Fan Improves Visibility Inside Chamber While Cleaning
- Built-In Air Pressure Regulator and Gauge
- Adjustable Leveling Pads for Added Stability on Uneven Floors
- Holds Up to 3.5 Gallons of Cleaning Solution



### 4 Gallon Mobile Parts Washer

SKU 546660 24804 **179<sup>99</sup>**

- Lid Has Positive Seal and Latches for Mobility
- 4 GPM Pump
- Dimensions: 26" (L) x 18" (W) x 9.5" (H)



### Portable Bucket-Top Parts Washer

SKU 003759 24816 **59<sup>99</sup>**

- Fits Most Standard 5 Gallon Buckets
- Includes: Submersible Pump, 40" Hose and Flow-Through Brush
- Pumping Rate: 1 GPM



Does Not Include 5 Gallon Bucket



## Biological Parts Washers

### Ocean Sunset 3.0 Pack

SKU OUTSIDE BUY/EPO SRIPAF0000623

**3,349<sup>99</sup>**

- 26 Gal. Tank Capacity
- Environmentally Friendly and Solvent Free
- Soak Sink for Cleaning of Heavy Soiled Parts
- Multi-Stage Heater
- Sealed Lid
- Includes: (5) 5 Gallon Containers of Bluesolution and 4 Tablets



### Gravity X2 Mobile Pack

SKU OUTSIDE BUY/EPO SRIPAF0000717

**2,199<sup>99</sup>**

- 10 Gal. Tank Capacity
- Heating Speed of 15 Minutes
- Regulated to 100°F
- Easy to Move Around
- Environmentally Friendly and Solvent Free
- Simple Controls
- Easy Maintenance
- Air or Electric
- Includes: (2) 5 Gallon Containers of Bluesolution and 4 Tablets



For Outside Buy/EPO, Call 901-300-4878

### BlueTablets SRBT

SKU 1485037 SRIOFOMB1100

**89<sup>99</sup>**

- Simple Small Tablets
- Convenient
- Qty: 4 Tablets



### BlueLiquid SRBLPE+ Aqueous Solution

SKU 1485035 SRIPF0L2P-100

**159<sup>99</sup>**

- Designed for Industrial Cleaning
- Concentrated Cleaning Solution for Biological Parts Cleaning
- Water Based
- ECO friendly



## Washer Accessories

### Straight Handle Flow Thru Parts Washer Brush

SKU 1368637 BRMPWA **39<sup>99</sup>**

- Made with Synthetic Filaments to Resist Solvent Cleaners
- Works with Most Popular Recirculating Parts Washers
- For Use in Either Petroleum-Based or Water Based Solutions



### Parts Washer Brush without Tube

SKU 1368624 BRMPWANT **34<sup>99</sup>**

### Air Operated Sprayer

SKU 222507 LIN5983 **74<sup>99</sup>**

- 1/4" NPT (F) Inlet
- Max. Operating Pressure: 150 psi
- Can Be Used with Solvents or Detergent Solutions



## Abrasive Blasting

### Bench Top Abrasive Blast Cabinet

SKU 300119 24815 **274<sup>99</sup>**

- Easily Remove Paint, Rust and Oxidation
- Fits on the End of Any Bench or Cabinet
- Overall Height: 19.3"
- Exterior Width: 19.3"
- Work Area: 3.18 Cubic Ft.
- Includes: 10 Replaceable Window Underlays



### 25 Lb. Glass Bead Blasting Media

- Ideal for Many Uses
- Removes Surface Rust
- Paint and Body Applications

#### Coarse

SKU 010136 SHA13077 **184<sup>99</sup>**

#### Medium

SKU 010139 SHA13078 **184<sup>99</sup>**

# SHOP EQUIPMENT

## Spray Wash Cabinets

- Heavy Duty Steel Construction
- Removable Parts Tree
- Brass Nozzles
- Heavy Duty Rubber Casters
- Stainless Oil Skimmer
- Removable Tank Screen

Each Cabinet Includes: 20 Lb. Aluma-Klean Soap Bucket

**VALUE:**  
**\$129.99**



Inside Height 43"



### Aluma-Klean Soap Bucket

20 Lb.  
SKU 751966  
RAN5155096

**129<sup>99</sup>**



50 Lb.  
SKU 1442593  
RAN5155100

**274<sup>99</sup>**

## Solvent-Free Cleaning Solution



### Heavy Duty Degreaser Concentrate (5 Gallons)

SKU 227558  
WWSHD-5G **279<sup>99</sup>**

Designed to Effectively Replace Hazardous Solvent in Water-Based Parts Washers

- Quickly Removes Grease, Oil, Carbon and Grime While Safe for the Technician



SKU	Part #	Product	Tank Capacity	Load Capacity	Price
OUTSIDE BUY/EPO	RANRS500DS	Stainless Steel	50 Gallon	500 Lb. Load	<b>10,799.99</b>
OUTSIDE BUY/EPO	RANRS750DS	Stainless Steel Truck	53 Gallon	1,000 Lb. Load	<b>11,499.99</b>
OUTSIDE BUY/EPO	RANRS500D	Professional	50 Gallon	500 Lb. Load	<b>7,399.99</b>
OUTSIDE BUY/EPO	RANRS750D	Truck	53 Gallon	1,000 Lb. Load	<b>7,899.99</b>



Customer Responsible For Offloading, Liftgate Service Available. For Outside Buy/EPO, Call 901-300-4878

## Better for the Environment and the Bottom Line



**Toucan Pack**<sup>®</sup>  
The absorbent recycling pack



### All-in-One Cleaning Concept

The **Toucan Pack** is an all-in-one mobile cart that distributes and recycles Fibercan+<sup>®</sup> Absorbent. Clean up oils, coolant, solvents and water **while saving money** by reusing the absorbent up to eight times.

- 1 Effective**  
Instant absorption safely dries floors. Leaves no greasy film and eliminates dust.
- 2 Economical**  
Ideal for small and large clean ups. Absorbs up to 8 times more spills than traditional sawdust and granules.
- 3 Efficient**  
Cart includes tools, sifting tray, Fibercan+ Absorbent and space for mats, gloves, etc.

### 8 Times More Savings

Traditional Absorbents **VS** Fibercan+ Absorbents

Consumption

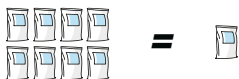

**Toucan Pack**<sup>®</sup>  
SKU OUTSIDE BUY/EPO  
SRIPFPAF00015 **999<sup>99</sup>**

- Includes: Mobile Cart, (1) 20 Lb. Bag of Fibercan+ Absorbent, Easy to Reach Collection Tray, Ergonomic Sifting System, Broom, Dust Pan and Tool Holder

**Fibercan+ Absorbent**  
SKU 1414395  
SRI0PEAFIC001

**69<sup>99</sup>**  
• 20 Lb. Bag



Scan for video

## Pipe Bender

**BB-2 Pipe Bender with 302 Die Package**  
SKU OUTSIDE BUY/EPO BENBB2

**10,349<sup>99</sup>**

- Knee Control and Depth-of-Bend Degree Plate for Manual Bending Operations
- Includes: BB-2 Tooling Package, Quick Release Bending and Finishing Dies, High-Speed Clampless Swager and Internal Expander

**1302 Automatic with 302 Die Package**  
SKU OUTSIDE BUY/EPO BEN1302BAS302

**11,149<sup>99</sup>**



## BendPak



**Large 3" Die Package - Optional**

SKU OUTSIDE BUY/EPO BEN300-1

**1,439<sup>99</sup>**

- Optional Die Package Extends the Bending Capabilities of Your BendPak Pipe Bender

For Outside Buy/EPO, Call 901-300-4878

## Drill Press

OEM TOOLS

**15" 16 Speed Floor Drill Press**

SKU 082857 24992

**SAVE \$50**

**449<sup>99</sup>** REG. \$499.99

- Drilling Depth: 3-5/16"
- 16 Speed Spindle: 240 to 3,200 RPM
- Dimensions: 15" x 25-1/3" x 63-1/3"
- Distance from Spindle to Table: 27"
- Distance from Spindle to Base: 47"

Offer Good While Supplies Last Through March 31, 2025



Chuck Size: 5/8" JT3 Taper

Swings: 15"

## Shop Vacuums

**8 Gallon Wet/Dry Vacuum**  
SKU 750618 BIG55271

**BigVac**  
**134<sup>99</sup>**

- Positive Lock on Hose System Eliminates Unexpected Disconnections
- Swiveling Casters for Ease of Movement in All Directions
- 5.5 HP Peak Motor



**Air Blow and Suction Gun**

SKU 1168663 26038 **39<sup>99</sup>** REG. \$49.99

OEM TOOLS

**SAVE \$10**

- One-Touch Button That Changes the Gun from Blow to Suction
- Standard Shop Vacuum Power for Quick and Easy Clean Up
- Lightweight Gun
- High Filtration Collection Bag
- Rugged and Durable Metal Construction and Easy-to-Use Trigger
- 1/4" PT/NPT Inlet and 90 psi



Offer Good While Supplies Last Through March 31, 2025

## Headlight Aimer

SYMTECH

**Headlight Aiming System**  
SKU OUTSIDE BUY/EPO SYMHBA5

**2,629<sup>99</sup>**

- Certified in Maryland and Virginia
- Laser Floor Slope Measurement (Accurate, Precise and Easy to Achieve)
- Photosensor Positioning



For Outside Buy/EPO, Call 901-300-4878

## Key Programmer

**Smart Pro Lite Vehicle Key Programmer**  
SKU 1414393 KABSMARTPROLT

Ilco

**1,999<sup>99</sup>**

- Includes: OBDII Cable, Main Cable, Charger and Hard Body Case
- Wi-Fi and Bluetooth Connectivity
- 75% Vehicles in Operation Coverage
- Compatible with the ADC245 Smart Aerial Plus+ and MyKeysPro (MKP)
- No Need to Purchase Tokens, Software or Standard UTP
- Free Updates for 1 Year
- Only Works with Ilco Remotes and Keys, Not Compatible with Other Brands



## Key Machines

- Includes Three Functions: Copy by Original, Decode and Cut by Code
- Fast Key Search - Enter Make/Model/Year and the Software Guides You Through the Process
- US Based Tech Support Available

**Futura Auto Electric Key Machine**

SKU 1267953 KABFUTURAAUTO

**4,649<sup>99</sup>**

- User Friendly Software with Step-By-Step Instructions
- Multiple Language Support
- Step-By-Step Calibration
- Automatic Tip Detection for Tip Gauged Keys



**Futura Pro Electric Key Machine**

SKU 1267950 KABFUTURAPRO

**10,649<sup>99</sup>**

- Two Cutting Stations - One for Edge and One for Laser and Dimple Keys



## Popular Remote Assortment Kits

Ilco

**35 Piece Most Popular**

SKU 1267947 KAB0221-35

**1,449<sup>99</sup>**

**100 Piece Most Popular**

SKU 1267939 KAB0221-100

**3,399<sup>99</sup>**

**35 Piece Most Popular Late Model**

SKU 1267965 KAB0221-35LM

**1,559<sup>99</sup>**

Go to [AZTOOL1.com](http://AZTOOL1.com) for Remote Kit Component List and Application Chart



# SHOP EQUIPMENT

## Pressure Washers

### 3100 psi 2.2GPM Gas Cold Water Pressure Washer

SKU OUTSIDE BUY/EPO CHM100780

**459<sup>99</sup>**

- Onboard Storage for the High Pressure, Hose, Trigger Gun and Spray Wand
- High-Performance Annovi Reverberi Axial Cam Pump Provides Consistent Cleaning for Everyday Jobs
- Includes: 5 Quick-Connect Nozzles, Storage Strap, High Pressure Hose (25'), Trigger Gun, Detergent Hose, Oil Funnel, Spray Wand and Engine Oil



WARRANTY: 2 Years Limited



### Electric Pressure Washer

SKU OUTSIDE BUY/EPO MTMCW3004SME1

**5,049<sup>99</sup>**

- Diesel or Kerosene Fired Burner
- Fuel Consumption: 1.3gph
- 3000 psi, 3.9 GPM
- 8.0 HP, 230V
- Includes: Quick Connect Nozzles - 0°, 15°, 25° and 40°, 50' x 3/8" High Pressure Hose, Insulated Trigger Gun, Adjustable Pressure Insulated Dual Lance and 35' Power Cord

WARRANTY: 1 Year Electric Motor and 7 Year General Pump



**NEW**



### Wall Mount Electric Pressure Washer

SKU OUTSIDE BUY/EPO MTMCW2004ME1

**3,549<sup>99</sup>**

- Pump Accepts Incoming Water Up to 165°F
- 2000 psi, 3.9 GPM
- 6.0 HP, 230V
- Includes: Quick Connect Nozzles - 0°, 15°, 25° and 40°, 50' x 3/8" Hose and 36" Adjustable Pressure Dual Lance

WARRANTY: 1 Year Electric Washers and 7 Year General Pump



**NEW**



## Hot Water Pressure Washers

### HSE 1400 psi Hot Water Pressure Washer

SKU OUTSIDE BUY/EPO MTMHSE1400M11

**3,149<sup>99</sup>**

- Diesel or Kerosene Fired Burner
- 1400 psi, 2.0 GPM
- 1.5 HP, 120V
- Includes: 50' x 3/8" Wire Braided Hose, Adjustable Pressure Insulated Dual Lance with 15° Fixed and Detergent Nozzle



WARRANTY: 1 Year Electric Motor, 3 Years Coil and 7 Years Mi-T-M Pump

### HSE 1500 psi Hot Water Pressure Washer

SKU OUTSIDE BUY/EPO MTMHSE15020MM

**3,899<sup>99</sup>**

- Diesel or Kerosene Fired Burner
- Fuel Consumption: 1.2gph
- 1500 psi, 2.0 GPM
- Temperature Rise: 150°F (66°C); Max. Outlet Temperature: 200°F (93°C)
- Includes: Quick Connect Nozzles - 0°, 15°, 25° and 40°, 50' x 3/8" Wire Braided Hose and Adjustable Pressure Insulated Dual Lance



WARRANTY: 1 Year Electric Motor, 3 Years Coil and 7 Years Mi-T-M Pump



## Floor Scrubbers

### Battery Powered 14" Floor Scrubber

SKU OUTSIDE BUY/EPO IPCCT15

**4,674<sup>99</sup>**

- Height-Adjustable Handle
- Removable Recovery Tank
- 1.5 Hour Run Time
- Includes: Lithium Battery, Charger and Brush



**NEW**

### Battery Powered 20" Floor Scrubber

SKU OUTSIDE BUY/EPO IPCCT50

**4,914<sup>99</sup>**

- 13 Gallon Tank Capacity
- 2.5 Hour Run Time
- For Up to 10 Bay Shop
- Includes: Self-Leveling Brush Head and Cast Aluminum Squeegee Assembly, 2 AGM Maintenance Free Batteries and Charger



**NEW**



### Cleaner/Degreaser 1 Quart Bottle (6 Pack)

SKU OUTSIDE BUY/EPO IPTC80451

**84<sup>99</sup>**

- High Performance Concentrated Formula Quickly Cuts through Grease, Oil and Tough Carbon Soils

To Confirm Price, Availability and Ordering Instructions on Outside Buy/EPO Call 901-300-4878

## Dual Fuel Powered Generator

### 7500 Watt Portable Gasoline Generator

SKU OUTSIDE BUY/EPO CHM201182

**999<sup>99</sup>**

- Gasoline Starting Watts: 9375
- Gasoline Running Watts: 7500
- Outlets: GFCI 120V Duplex (5-20R), (2) 120/240V (L14-30R), 120/240V (14-50R)
- Wireless Remote Start
- Free Lifetime Technical Support



WARRANTY: 3 Years Limited

CARB Compliant



## SHOP OWNERS, WE LOAN SPECIALTY TOOLS FOR SPECIAL JOBS!

### AUTOZONE® LOAN-A-TOOL® PROGRAM

Over 90 Specialty Tools for Loan or Sale

We offer the most complete selection of tools for a variety of jobs, from steering and suspension, air conditioning, engine repair and more.

The best part is Loan-A-Tool® products are free to use! Leave a deposit at the store when you pick up the tool. When you're through just bring it back within 90 days, and we'll refund the deposit, or keep the tool.

See your Commercial Sales Manager for a complete list of loaner tools.



Ford Triton Spark Plug Porcelain Extractor Master Set



A/C Flush Kit



Fuel Injector Puller Kit - VW/Audi

## Dent Repair

### Adjustable Bumper Stand

SKU **OUTSIDE BUY/EPO**  
ATD6572 **219<sup>99</sup>**

- Holds Any Plastic Bumper Cover without Touching the Painted Surface
- Cover Can Be Rotated 90° to Ensure Proper Paint Coverage
- 5 Locking Positions
- Protective Rubber Boots Keep Critical Areas Free of Overspray
- 4 Industrial Grade Casters with 2 Locking for Zero Movement



### 3-Shelf Parts Cart

SKU **OUTSIDE BUY/EPO**  
ATD6569 **334<sup>99</sup>**

- 3 Adjustable Shelves and Support Arms Provide Mobile Parts Storage
- Weight Capacity per Shelf: Bottom and Middle Shelf: 99 Lb., Top Shelf: 66 Lb.
- 6 S-Hooks
- (4) 4" Polyurethane Casters (2 Locking)



For Outside Buy/EPO, Call 901-300-4878

## Dent Puller

### Slide Hammer Dent Puller Set

SKU **265148**  
25922 **129<sup>99</sup>**

- 12 Lb. Hammer, Slide Hammer Shaft, Slide Hammer Handle, Slide Hammer Adapter, Deep Hook, Short Hook, Door Edge Tool, Claw, Straight Driver, Hook and Chain, Sheet Metal Screw and Holder, Nose Piece with Screw
- Comes in a Blow Mold Case



OEM TOOLS

### Uni-Vac™ Vacuum PDR Pulling Tool

SKU **1485044**  
HSADTK-7700 **29<sup>99</sup>**

- Pull Dents on Painted Panels without Glue
- Portable, No Compressed Air Required
- 3", 4" and 5" Rubber Suction Cups
- Chrome Plated 28" Steel Bar
- Rubber-Sleeved Hammer Spool



## Windshield Tool

### 18" Professional Windshield Knife

SKU **480782**  
CAL53100 **29<sup>99</sup>**

- Constructed of Heavy Duty Steel and Aluminum with a Padded Ergonomic Handle

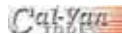

## Door Tools

### Door Spring Tool

SKU **447118**  
25336 **11<sup>99</sup>**

- Quickly and Easily Remove or Install Door Hinge Springs
- Designed for GM Cars and Light Trucks



OEM TOOLS

### 5 Piece Door Panel and Trim Remover Set

SKU **989263**  
25312 **39<sup>99</sup>** REG. \$45.99

- Comprised of 3 Door Panels and 2 Trim Tools
- Textured, Comfortable Grips with Thumb Stop and Hanging Hole

Offer Good Through March 31, 2025



### 6 Piece Door Panel and Trim Removal Set

SKU **003868**  
25301 **49<sup>99</sup>** REG. \$59.99

- Includes: V-Notch Clip Remover, U-Notch Clip Remover, 2 Door Panel Removal Tools, C-Type Clip Removal Tool and Handle Clip Removal Tool

Offer Good Through March 31, 2025



### Door Hinge Adjuster

SKU **447144**  
25946 **84<sup>99</sup>**

- Adjusts Door Hinge Position on Most Vehicles
- 2-Head Adapter Works with Large and Small Latches
- Excellent Grip for Ease of Use
- Provides Leverage to Get the Job Done



## Body Repair

### Fast Action Body Repair Kit

- Includes: Hydraulic Pump, Hydraulic Ram, 4 Extension Rods, a Rubber Ball Foot and a Duckbill Hydraulic Spreader
- Features a Faster Double-Action Hydraulic Pump
- Includes: Blow Mold Case

**4 Ton**  
SKU **301327**  
24820 **179<sup>99</sup>**

**10 Ton**  
SKU **301328**  
24821 **199<sup>99</sup>**



### 3 Piece Body Seam Splitter Set

SKU **265129**  
25337 **38<sup>99</sup>**

- Includes: Straight, 30° Offset and 90° Angle Seam Splitters
- Tough Chrome Vanadium Steel
- GoThru® Shafts
- Shock Dampening Grip Provides Comfort



OEM TOOLS

## Hood Props

### Telescopic Hood Support

SKU **420337**  
24211 **19<sup>99</sup>**

- Simple Turn Locks and Unlocks the Support in Place
- Rubber End Caps Protect Vehicle's Finish
- 21" When Closed and Almost 48" When Fully Extended
- Compact and Easy to Store, Easy to Use



48" REACH

### Universal Lift Support Clamp

SKU **191671**  
25307 **29<sup>99</sup>**

- Securely Holds Weak Lift Supports in the Extended Position to Allow Access to the Engine Compartment or Luggage Area



OEM TOOLS

## Headlight Tools

### Headlamp/Taillight Removal Tool Set

SKU **1485047**  
HSAUNI-7800 **39<sup>99</sup>**

- Features Two Lever Arms and Two Feeler Locator Strips
- Allows Removal of Modules Without Breaking Off Tabs
- Won't Scratch Surface Paint
- Allows for Quick Removal and Snap-In Replacement



NEW

## Trim Tools

### Air Bag Release Tool for GM

SKU **191678**  
25310 **19<sup>99</sup>**

- Fits Most GM Cars, Minivans and Light Trucks
- Tips are Tapered to Make Removal Easier



OEM TOOLS

### Trim Fastener and Molding Remover Set

SKU **900801**  
25314 **14<sup>99</sup>**

- Includes: 5 Tools for Easy Removal of Fasteners, Molding, Wheel Hubs and More
- For Use on Internal and External Vehicle Molding and Trim Fasteners



### 3 Piece Light Duty Smoothing/Prying Kit

SKU **004111**  
25084 **22<sup>99</sup>**

- Pry Dashboard Parts and Vents without Damaging Interior
- Clean Crevices and Joints in Small Electronics
- Disassemble Key Fobs and Other Remotes
- Evenly Smooth Epoxy and Adhesives

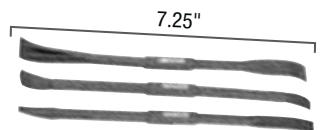

7.25"

# WELDING & CUTTING

## Welding

### Spot Welder 120V

SKU 814396 **169<sup>99</sup>**  
24819

- Convenient 120V AC Input Power
- Spot Welds Uncoated Mild Steel Including Galvanized and Stainless
- Output Current: 13.5A
- Rated Duty Cycle: 50% @ 1.5kVA

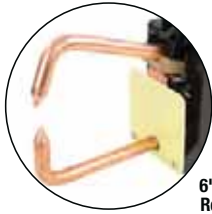

Includes  
6" Tongs and  
Replacement  
Tips



OEM TOOLS

### Stick Welder 110V (70 Amp)

SKU 814387 **129<sup>99</sup>**  
24818 REG. \$149.99

- DC Inverter Powered for Improved Efficiency and Control
- Lightweight and Portable
- Welds Mild Steel, Stainless and Cast Iron
- Includes: 5' Ground Cable and Clamp, 6.5' Electrode Cable and Rod Holder, Shoulder Strap Mask and Combo Brush/Hammer

SAVE  
**\$20**



Offer Good While Supplies Last Through  
March 31, 2025

OEM TOOLS

### Flux Core Welder 110V (70 Amp)

SKU 814197 **249<sup>99</sup>**  
24817

- Rated Duty Cycle: 20% @ 70 Amps
- Adjustable Wire Feed Speed
- High and Low Output Settings
- Includes: Welding Gun and Cable, Ground Cable with Clamp, Chipping Hammer/Brush, 1 Spool of .035" Flux Core Wire and Protective Face Shield with Welding Lens



OEM TOOLS

### MIG and Flux-Core Welder (130 Amp)

SKU OUTSIDE BUY/EPO **589<sup>99</sup>**  
HSAHSW-6213

- Features Wire Speed and Power Settings by Material/Wire Thickness
- Rated Duty Cycle: 20% @ 130 Amps
- Includes: Inverter, Power Supply, Torch, Earth Clamp, Gas Regulator, Spool of .030" FluxCore Wire and Spool of .030" MIG Wire



H&S  
AUTOSHOT

For Outside Buy/EPO,  
Call 901-300-4878

## 3-in-1

### Multi-MIG Welder 140A Synergic with Opt. TIG, Stick, Spool Gun

SKU OUTSIDE BUY/EPO **824<sup>99</sup>**  
HSAHSW-6215

- 140A Synergic with Opt. TIG, Stick, Spool Gun
- Output Power 140 Amps at 35% Duty-Cycle
- Large 7" LCD Display and Touch Pad Select
- Compact High-Efficiency Inverter Design
- Aluminum Spool Gun Ready
- #15 Mig Gun 10 Ft. and Earth Clamp Cable 10 Ft.
- Includes: Multi-MIG Welder, SMART MIG, TIG, Stick and Spool Gun



HSAHSW-6215

H&S  
AUTOSHOT

### Multi-MIG Welder 200A Synergic with Opt. TIG, Stick, Spool Gun

SKU OUTSIDE BUY/EPO **1,029<sup>99</sup>**  
HSAHSW-6222

- 200A Synergic with Opt. TIG, Stick and Spool Gun
- Output Power: 200 Amps at 35% Duty-Cycle
- Large 7" LCD Display and Touch Pad Select
- Includes: Multi-MIG Welder, SMART MIG, TIG, Stick and Spool Gun

NEW



### 200A Multi MIG Synergic, TIG & Stick Welder (115-230VAC)

SKU OUTSIDE BUY/EPO **2,199<sup>99</sup>**  
HSAHSW-6420

- Welds MIG, DG TIG & Stick up to 3/8" Mild Steel 115V or 230V
- High-Powered Inverter CSA/UL Rated 200A @ 35% DC
- 16 Program LCD Synergic Input
- Includes: Welder, 3-Guns, Earth Clamp Cable, Foot Pedal, 115V Adapter, Gas Regulator, Wire and TIG Kit. AL Spool Gun Ready

**BONUS VALUE: \$214.99**

### Welding Cart with Cylinder Support

SKU OUTSIDE BUY/EPO  
HSAHSW-7000

- Works with Plasma Cutters HSW-6213, HSW-6215, HSW-6222, HSW-6420 and HSW-6422

With Purchase of:

HSAHSW-6215, HSAHSW-6222 or HSAHSW-6420

Offer Good While Supplies Last Through March 31, 2025



To Confirm Price, Availability and Ordering Instructions on Outside Buy/EPO,  
Call 901-300-4878

## Plasma Cutter

### 40A Plasma Cutter (115-230VAC)

SKU OUTSIDE BUY/EPO **1,499<sup>99</sup>**  
HSAHSW-6004

- Genuine Cut 1/2" and Severance Cut 1" Mild Steel 115V or 230V
- High-Powered Inverter CSA/UL Rated 40A @ 50% DC
- LCD Display Output Power, Air Pressure, Grid or Standard Cut
- Includes: Plasma with Regulator-Filter, 48 Gun, Earth Clamp Cable, 115V Adapter and Spare Contact Drag Tips and Electrodes



H&S  
AUTOSHOT

For Outside Buy/EPO, Call 901-300-4878



# WELDING & CUTTING

TO ORDER, contact your Commercial Sales Manager or go to [AutoZonePro.com](http://AutoZonePro.com)

WELDING & CUTTING

## Welding Helmets

### Auto Darkening Welding Helmet

SKU 1089051 **199<sup>99</sup>**  
HSAHSW-7030

- Large Visibility Auto Darkening Lens (4.5" x 5.25")
- Adjustable Grind/Weld, 9 to 13 DIN, Sensitivity and Delay
- Solar Cell and Lithium Battery Power
- Spare Inner and Outer Protective Lenses
- Helmet Bag Included



### Auto Darkening Welding Helmet

SKU 362974 **54<sup>99</sup>**  
24357

- TIG Rated Variable Shade 9 to 13
- Viewing Area: 3.54" x 1.37"
- Battery Powered with Solar Assist
- Includes Replacement Cover Lenses



### Auto Darkening Welding Helmet with Grinding Function

SKU 347233 **69<sup>99</sup>**  
24358

- TIG Rated Variable Shade 9-13
- Variable Sensitivity and Delay Controls
- 2 Independent Arc Sensors
- Grinding Function
- Lens Darkening is 1/25,000
- Battery Powered with Solar Assist
- Includes Replacement Cover Lenses
- Viewing Area: 3.62" x 1.65"



### Premium Welding Helmet - Gray Matter

SKU 1400038 **119<sup>99</sup>**  
JAS47102

- 6.24 Sq. Inch Viewing Area
- Auto Darkening Filter Meets 1/1/1/1 Optical Clarity Standard, the Highest in the Industry
- Powered By Solar Technology and (1) CR2032 Lithium Battery



## Welding Accessories

### Welder's Combo Pack

SKU 459159 **54<sup>99</sup>**  
SHA14526

- Includes: Heavy Duty Welding Gloves, Quilted Welder's Skull Cap and Oxy-Acetylene Lighter



### Premium TIG/MIG Welding Gloves

SKU 1137810 **29<sup>99</sup>**  
HSAHSW-9007

- Premium Glove for TIG Welding; Also Suitable for MIG
- Wing Thumb and 6" Split Leather Extended Cuff
- Kevlar-Stitched for Extra Durability
- Used for Maximum Dexterity and Protection
- 14" Glove Length



## Mini-Ductor

### Mini-Ductor II

SKU OUTSIDE BUY/EPO **559<sup>99</sup>**  
IDIMD-700

- Ergonomic Cylinder
- No-Slip Grenade Grip
- LED Illumination
- Push Button Activation
- Operates on 120 Volts/1000 Watts of Power
- Includes: Pre-Formed Coil, U-Form Coil, Bearing Buddy Coil and Carrying Case



For Outside Buy/EPO,  
Call 901-300-4878

## Soldering

### Butane Torch

SKU 1189064 **12<sup>99</sup>**  
20910

- Butane Flow Regulator for Flame Adjustment
- Dual Flame Mode for Controlled or Continuous Flame Output
- Safety Feature Allows User to Lock Torch When Not in Use



Butane Not Included

### Mechanics Butane Torch

SKU 802236 **22<sup>99</sup>**  
24354

- Heavy Duty Piezo Ignition with Strong Flame



Butane Not Included

### Professional 3-in-1 Butane Micro Torch Kit

SKU 420339 **39<sup>99</sup>**  
24356

- 3-in-1 Design Can Be Used as a Soldering Iron, Torch or Hot Air Blower without Iron Tip
- Micro Torch Kit Includes: Torch, Metal Tip Wicking Cup with Sponge, Heat-Shrink Deflector, Chisel Point Tip, Anvil Solder Tip, Needle Tip and Hot Air/Soldering Tip and Base
- Ideal for Use with Electrical Repair, Tin and Plastic Melting, Heat-Shrinkable Tubing, Auto Repair, Hobby Repair and Jewelry Repair
- Power Range: 30W to 125W



Butane Not Included

### Mechanics Butane Mini Torch

SKU 804655 **17<sup>99</sup>**  
24353

- Adjustable Flame Lights Upside Down
- Auto Ignition, Refillable
- Safety Lock When Not in Use



Butane Not Included

### Professional 3-in-1 Butane Soldering Iron Kit

SKU 420338 **34<sup>99</sup>**  
24355

- Includes: Soldering Iron, Metal Tip Wicking Cup with Sponge, Solder Wire, Protective Tip Cap, Heat-Shrink Deflector, Chisel Point Tip, Anvil Solder Tip, Needle Tip and Hot Air/Soldering Tip
- Cable Free



### Professional Soldering Gun Kit

SKU 1362003 **39<sup>99</sup>**  
24773 REG. \$49.99

- Includes: Heavy Duty 230/150-Watt Soldering Gun, General Purpose Soldering Tip, Plastic Cutting Tip and 0.5 Oz. (14g) Rosin Core Solder
- Reaches Max. Temperature of 937°F at Low Power
- Reaches Max. Temperature of 1400°F at High Power
- 120V, 150/230W, 60 Hz

SAVE \$10



Offer Good While Supplies Last  
Through March 31, 2025

## Consumables



SKU	Part #	Wire	Diameter	Weight	Price
459164	SHA12003	MIG Solid Wire E70S6	.030	11 Lb.	<b>49.99</b>
459175	SHA12008	Flux Core Welding Wire	.030	2 Lb.	<b>34.99</b>
459180	SHA12009	Flux Core Welding Wire	.035	2 Lb.	<b>32.99</b>



Prices subject to change without notice. Prices do not include applicable taxes, vehicles, tires, rims, installation or optional equipment as shown. Please do not return purchases to the store. For information regarding warranty, repair, or any questions or concerns, call 901-300-4878.

AZG0125

129

# HAND TOOLS

## Combo Wrench Sets

### RingStop® Reversible Ratcheting Wrench Set

- Patented RingStop® Design Makes One-Hand Use Easy
- Posi-Grip No-Slip® Design
- Jaw is 15° Offset
- Made with Chrome Vanadium Steel



Go Thru Ratcheting Head



## Flex Head Flare Nut Wrench Set **OEM TOOLS®**

### 5 Piece (SAE)

SKU 749849 **69<sup>99</sup>**  
22063

- 1/4" x 5/16", 3/8" x 7/16", 1/2" x 9/16", 5/8" x 11/16", 3/4" x 7/8"



10" Width x 7.8" Depth

**BONUS**  
**VALUE: \$9.99**

**Medium Fuel Line Hose Clamp**  
25379



With Purchase of 22063 or 22064

**Offer Good While Supplies Last Through March 31, 2025**

### 8 Piece Set (SAE)

SKU 803139  
23989 **99<sup>99</sup>**

- SAE Sizes: 5/16", 3/8", 7/16", 1/2", 9/16", 5/8", 11/16" and 3/4"



10" Width x 7.8" Depth

### 12 Piece Set (Metric)

SKU 803140  
23988 **149<sup>99</sup>**

- Metric Sizes: 8, 9, 10, 11, 12, 13, 14, 15, 16, 17, 18 and 19 mm



15" Width x 10" Depth

**BONUS VALUE: \$21.99**

### 8 Piece Go Thru Socket Set (SAE)

22979



With Purchase of 23989

**Offers Good While Supplies Last Through March 31, 2025**

**BONUS VALUE: \$29.99**

### 12 Piece Go Thru Socket Set (Metric)

22978



With Purchase of 23988

## Combo Wrench Sets

### 14 Piece (SAE)

SKU 802222 **99<sup>99</sup>**  
23993 REG. \$119.99

- 1/4", 5/16", 3/8", 7/16", 1/2", 9/16", 5/8", 11/16", 3/4", 7/8", 15/16", 1", 1-1/16" and 1-1/8"

**Offer Good Through March 31, 2025**

**SAVE \$20**

### 16 Piece (Metric)

SKU 802224 **119<sup>99</sup>**  
23994

- 6, 7, 8, 9, 10, 11, 12, 13, 14, 15, 16, 17, 18, 19, 21 and 22 mm



## 10 Piece Combination Wrench Set (Metric)

SKU 127920 **54<sup>99</sup>**  
22995

- Includes: 10 to 19 mm
- Posi-Grip No-Slip® Design Provides Off-Corner Loading for Greater Torque with More Socket-to-Fastener Contact
- Marked on All 4 Sides for Easy Identification

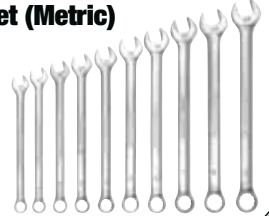

# JUMBO WRENCHES

Jumbo wrenches are made of high quality drop forged steel and are precision machined to prevent fastener damage.

**Individual Jumbo Wrenches Available on AZTOOL1.COM**

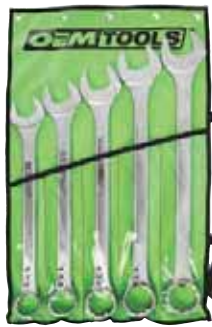

Sets Include Roll-Up Storage Bag

SKU	Part #	Metric or SAE	Size	Price
338830	22100	SAE	1-1/16", 1-1/8", 1-1/4", 1-5/16", 1-3/8" and 1-7/16"	<b>89.99</b>
338833	22101	SAE	1-1/2", 1-5/8", 1-3/4", 1-7/8" and 2"	<b>119.99</b>
338852	22120	Metric	21 mm, 22 mm, 24 mm, 25 mm, 27 mm, 29 mm, 30 mm and 32 mm	<b>74.99</b>
338858	22121	Metric	33 mm, 34 mm, 35 mm, 36 mm, 40 mm, 42 mm, 46 mm, 50 mm	<b>139.99</b>

Box End Offset 15° for Work in Tight Spaces

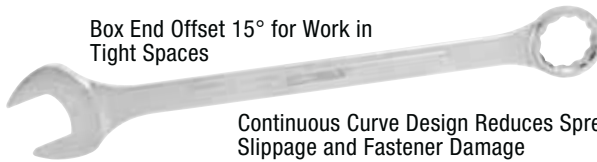

Continuous Curve Design Reduces Spreading, Slippage and Fastener Damage

SKU	Part #	SAE Size	Price
338859	22102	1-1/16"	<b>15.99</b>
338864	22103	1-1/8"	<b>17.99</b>
338866	22104	1-1/4"	<b>19.99</b>
338868	22105	1-5/16"	<b>21.99</b>
338877	22106	1-3/8"	<b>23.99</b>
338890	22107	1-7/16"	<b>25.99</b>
338896	22108	1-1/2"	<b>27.99</b>
338898	22109	1-5/8"	<b>29.99</b>
338903	22110	1-3/4"	<b>31.99</b>
338935	22111	1-7/8"	<b>34.99</b>



## Ratcheting Combination Wrenches



### 16 Piece 12 Pt. Ratcheting Combination Wrench Set (Metric)

SKU 213125 **189<sup>99</sup>**  
KDT9416

- Includes: 8, 9, 10, 11, 12, 13, 14, 15, 16, 17, 18, 19, 20, 21, 22 and 24 mm
- Ratcheting Box End Requires Only 5° to Move Fasteners
- 12 Point Design Providing More Positions to Engage the Fastener



## Wrench Extender



### Wrench Extender

SKU 1368628 **36<sup>99</sup>**  
22656

- Safely Provides Extra Leverage to Loosen Rusted Bolts, Jammed Fasteners or Over-Tightened Nuts
- Great for Use on Those Hard to Reach Fasteners



# HAND TOOLS

TO ORDER, contact your Commercial Sales Manager or go to [AutoZonePro.com](http://AutoZonePro.com)

HAND TOOLS

## Ratcheting Screwdriver

### Pivot-Grip Ratcheting Screwdriver

SKU 004103 22557 **21<sup>99</sup>**

- Pivoting Handle Provides Ergonomic Gripping Positions
- Forward and Reverse Ratcheting
- Magnetic Bit Shaft for a Secure Fit
- Overall Length: 10"
- Internal Bit Cartridge for Convenient Storage
- Includes: 6 Bits: Phillips (#1, #2), Slotted (4 mm, 6 mm) and Robinson (#1, #2)

Internal Bit Storage Pivoting Handle Rotates from Straight-Grip to Pistol-Grip



OEM TOOLS

## Screwdrivers

### 19 Piece Screwdriver Set

SKU 1142325 73775 **29<sup>99</sup>**

- Slotted: 3/32" x 1.5", 1/8" x 2.5", 3/16" x 4", 3/16" x 8" (Cabinet Tip), 1/4" x 1.5" (Stubby), 1/4" x 4", 1/4" x 6", 5/16" x 6", 3/8" x 8"
- Phillips: #0 x 1.5", #0 x 2.5", #1 x 3", #2 x 1.5" (Stubby), #2 x 4", #2 x 8", #3 x 6", #4 x 8"
- Offset: 3/16" x #1, 1/4" x #2
- Magnetic Shafts Hold Fasteners in Place
- Square Shafts Can Be Used with Wrench for More Torque
- Hexagon Shaped Handles Prevent Roll Off
- Color Coded Fluting Defines Driver Type



GreatNeck



Impact Resistant Acetate Handle (Fluted for Better Grip)



## Long Reach Screwdrivers

- High Performance Hex Shaped Shaft for More Torque and Less Flex
- Precision Machined and Sand Blasted Tips That Reduce Cam-Out
- Durable Ergonomic Handles are Made of Hardened Resin

### 5/16" x 20" Slotted Screwdriver

SKU 1142473 22555 **19<sup>99</sup>**

### #2 x 20" Phillips Screwdriver

SKU 1142485 22574 **16<sup>99</sup>**

3-Sided Comfort Handle

Extra Long Blades for Hard to Reach and Recessed Fasteners in Tight Spaces

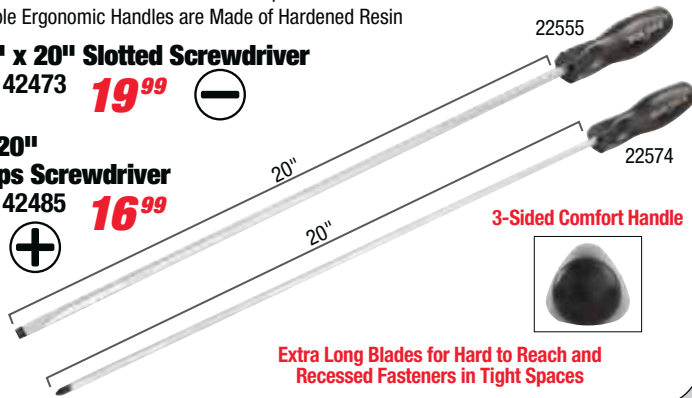

OEM TOOLS

### 8 Piece Mechanics Screwdriver Set

SKU 802208 23999 **59<sup>99</sup>** REG. \$69.99

- EVA Tray with Custom Cut Contrast Soft Foam and Sizes Marked for Easy Identification, Designed to Fit Securely in a Cabinet or Tool Box
- Features a Hard Chrome™ Finish, an Easy-to-Clean Smooth Satin Finish That Won't Show Prints and Keeps Rust Away
- Custom Cut of the Tool is a Hi-Vis Green Making it Visible if a Tool is Missing
- Slotted: 1/4" x 1-1/2", 3/16" x 3", 1/4" x 4", 5/16" x 6" and 3/8" x 8"



Offer Good Through March 31, 2025

## Star Screwdrivers

### 5 Piece Star Screwdriver Set

SKU 1142630 73721 **18<sup>99</sup>**

- Star (T10 x 4", T15 x 4", T20 x 4", T25 x 5", T30 x 6")



### 7 Piece Torx® Dual Material Screwdriver Set

SKU OUTSIDE BUY/EPO KDT80071H **99<sup>99</sup>**

- Torx® Sizes Included: T10, T15, T20, T25, T27, T30, T40
- "Speed Zone" Handle Design for Faster Rotation in Low-Torque Applications
- Non-Slip Black Oxide Tip for More Secure Fit in Fastener
- 6" Laser Etched Blades with Part Number and Size for Quick Identification



For Outside Buy/EPO, Call 901-300-4878

GEARWRENCH

## Hex Key Sets

### 27 Piece Star and Hex Key Set (Metric and SAE)

SKU 1209375 24299 **59<sup>99</sup>**

- Extra Long Arm for Accessing Hard-to-Reach Spots
- Each Tool is Color Coded and Marked with Sizes for Easy Identification
- SAE and Metric Hex Keys Have Ball-End Design for Reaching at Angles Up to 25°



OEM TOOLS

S2 STEEL



- Manganese Phosphate Finish Resists Corrosion
- 25° Entry Angle for Better Work Near Obstructions
- Long Arms Provide for Increased Torque and Extra Reach

S2 STEEL

### 35 Piece SAE, Metric and Star

SKU 1168819 24249 **31<sup>99</sup>**

### 26 Piece SAE and Metric

SKU 1168833 24248 **24<sup>99</sup>**



### 9 Piece Magnetic Long Arm Hex Key Set Long - SAE

SKU 978109 24261 **22<sup>99</sup>** REG. \$27.99

- Includes SAE Sizes: 1/16", 5/64", 3/32", 1/8", 5/32", 3/16", 1/4", 5/16" and 3/8" Color Coded Red - SAE Magnetic Tips Hold Fasteners in Place and Prevents Them from Slipping

SAVE \$5



Offer Good Through March 31, 2025

## Gasket Scraper Set

### 3 Piece Gasket Scraper Set

SKU 1069069 26501 **24<sup>99</sup>**

- Includes: 3/4", 1" and 1-1/2" Gasket Scrapers



OEM TOOLS

Prices subject to change without notice. Prices do not include applicable taxes, vehicles, tires, rims, installation or optional equipment as shown. Please do not return purchases to the store. For information regarding warranty, repair, or any questions or concerns, call 901-300-4878.

AZG0125

131

# HAND TOOLS

## 10 mm Socket Set

### 10 Piece 10 mm Master Socket Set (Metric)

SKU 1267951 **29<sup>99</sup>**  
22463

- Magnetic Impact Sockets are Constructed with Chrome Molybdenum for Strength and Durability
- Includes: (5) 1/4" Drive Sockets and (5) 3/8" Drive Sockets

10 mm  
If You Know,  
You Know



OEM TOOLS

## Ratchet and Socket Set

### 26 Piece 1/2" Drive Ratchet and Socket Set

SKU 591154 **99<sup>99</sup>**  
23995

- Includes: (21) 6 Pt. Metric and SAE Sockets (1) 1/2" Dr. Extension Bar 3" (1) 1/2" Dr. Extension Bar L6 (1) 1/2" Swivel U-Joint (1) 1/2" Dr. Regular Ratchet

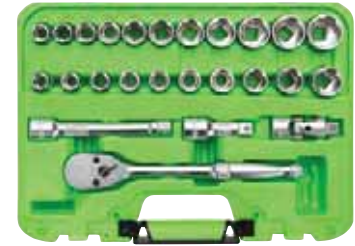

OEM TOOLS

## Mechanics Set

### 64 Piece 1/4" Drive Metric Set

SKU 020788 **99<sup>99</sup>**  
23997

- Shallow Sockets, 6 Pt: 4 to 15 mm
- Deep Sockets, 6 Pt: 4 to 15 mm
- Drive Wobble Straight Extension
- Bit Extension Bars: 6" and 10"
- Ratchet Screwdriver
- Universal Joint
- Ratchet
- 28 Bits



OEM TOOLS

20" Width x 8" Depth

## Universal Joints

### 1/4" Drive

SKU 081225 **9<sup>99</sup>**  
22520



OEM TOOLS

(Style May Vary)

### 1/2" Drive

SKU 081227 **11<sup>99</sup>**  
22522



### 3/8" Drive

SKU 081226 **10<sup>99</sup>**  
22521

## Socket Adapters

### 3 Piece Low-Profile Adapter Set

SKU 818570 **17<sup>99</sup>**  
22535

- CR-V Steel for Strength
- Get into Tighter Spaces
- Includes: 1/4" F x 3/8" M, 3/8" F x 1/2" M, and 1/2" F x 3/4" M



## Adapters

- Hard Chrome™ Finish is Easy to Clean and Will Keep Away Rust



22534

HARD CHROME™ FINISH

OEM TOOLS

SKU	Part #	Drive	Price
81228	22530	1/2" F x 3/4" M	<b>14.99</b>
81229	22531	1/2" F x 3/8" M	<b>10.99</b>
81230	22532	3/8" F x 1/2" M	<b>7.99</b>
81232	22533	3/8" F x 1/4" M	<b>6.99</b>
81233	22534	1/4" F x 3/8" M	<b>7.99</b>

## Socket Sets

- Posi-Grip No-Slip®
- Off Corner Loading for Greater Torque
- Knurling Position for Best Finger Gripping

- Chamfered Ends Allow the Socket to Easily Slip Over the Bolt Head
- Deep Marking for Easy Identification



### 1/4" Drive Socket Sets

#### 10 Piece (SAE)

SKU 127786 **21<sup>99</sup>**  
22952

- 3/16" to 9/16"

#### 12 Piece (Metric)

SKU 127836 **25<sup>99</sup>**  
22950

- 5 mm to 15 mm

#### 10 Piece Deep (SAE)

SKU 1414402 **26<sup>99</sup>**  
22953A

- 3/16" to 9/16"

#### 12 Piece Deep (Metric)

SKU 127772 **30<sup>99</sup>**  
22951

- 5 to 15 mm



### 10 Piece 1/4" Deep (SAE)

SKU 850056 **24<sup>99</sup>**  
23985

- Includes: 3/16" to 9/16"

### 12 Piece 1/4" Deep (Metric)

SKU 850510 **24<sup>99</sup>**  
23986

- Includes: 5 mm to 15 mm



10" Width x 4" Depth

OEM TOOLS



### 3/8" Drive Socket Sets

#### 11 Piece (SAE)

SKU 127798 **32<sup>99</sup>**  
22956

- 1/4" to 7/8"

#### 12 Piece (Metric)

SKU 127794 **35<sup>99</sup>**  
22954

- 8 mm to 19 mm

#### 11 Piece Deep (SAE)

SKU 127803 **37<sup>99</sup>**  
22957

- 1/4" to 7/8"

#### 12 Piece Deep (Metric)

SKU 127797 **40<sup>99</sup>**  
22955

- 8 mm to 19 mm



### 12 Piece 3/8" Deep Socket Set (Metric)

SKU 103402 **34<sup>99</sup>**  
23981

- Includes: 8 mm to 19 mm



10" Width x 7" Depth

### 1/2" Drive Socket Sets

#### 11 Piece (SAE)

SKU 127812 **39<sup>99</sup>**  
22960

- 1/2" to 1-1/8"

#### 10 Piece (Metric)

SKU 127807 **35<sup>99</sup>**  
22958

- 10 mm to 19 mm

#### 11 Piece Deep (SAE)

SKU 127846 **45<sup>99</sup>**  
22961

- 1/2" to 1-1/8"

#### 10 Piece Deep (Metric)

SKU 127809 **40<sup>99</sup>**  
22959

- 10 mm to 19 mm



### 24 Piece 3/8" Dr. Socket Set (Metric)

SKU 127868 **49<sup>99</sup>**  
22963

- Includes: 8-19 mm (Deep) and 8-19 mm (Shallow)

### 22 Piece 3/8" Drive Socket Set (SAE)

SKU 127869 **44<sup>99</sup>**  
22962

- Includes: 1/4" to 7/8" (Deep); 1/4" to 7/8" (Shallow)



# HAND TOOLS

TO ORDER, contact your Commercial Sales Manager or go to [AutoZonePro.com](http://AutoZonePro.com)

HAND TOOLS

## Ratchets

- 36 Teeth with 10° Arc Motion for Precision and Strength
- Reversing Lever Allows a Forward and Reverse in One-Hand Action
- Sealed to Keep Dirt and Debris Out of Head
- Compact Head Designed to Get into Tight Spaces

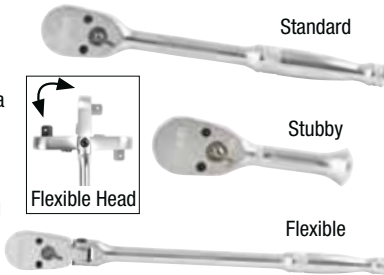

## HARD CHROME™ FINISH OEM TOOLS®

SKU	Part #	Type	Drive	Length	Price
081298	22900	Standard	1/4"	4-1/4"	18.99
177728	22911	Standard	3/8"	8"	34.99
177768	22920	Standard	1/2"	10"	43.99
177702	22910	Stubby	3/8"	4"	33.99
081301	22901	Flexible	1/4"	6"	29.99
177730	22912	Flexible	3/8"	11-1/2"	42.99
177769	22921	Flexible	1/2"	17-1/2"	45.99

## Extensions OEM TOOLS®

- Chamfered Ends for Positive Engagement with Drive Tools
- Knurled Shank for Easy Fingertip Turning
- Milled Ends Provide a Solid Connection

SKU	Part #	Drive	Length	Price
081213	22481	1/4"	4"	5.99
081215	22482	1/4"	6"	7.99
081218	22483	1/4"	11"	9.99
081219	22490	3/8"	1-3/4"	9.99
081220	22491	3/8"	4"	10.99
306326	22492	3/8"	6"	8.99
306287	22494	3/8"	10"	11.99
081212	22480	1/2"	2"	3.99
081221	22500	1/2"	3"	9.99
081223	22501	1/2"	6"	11.99
081224	22502	1/2"	10"	18.99

## Flex Head Breaker Bars

- Special Alloy Steel, Heat-Treated to Provide Durability
- 180° Flex Head Provides Leverage at Desired Angle for Hard-to-Reach Applications

SKU	Part #	Drive	Length	Price
081302	22913	3/8"	11-9/16"	19.99
750437	22923	1/2"	24"	29.99



OEM TOOLS®

HARD CHROME™ FINISH

## Impact Driver

### 1/2" Drive Impact Driver Set

SKU 1142387 22561 **27.99**

- Easily Break Free Rusted, Corroded and Frozen Screws
- Includes: Impact Driver, Bit Adapter, 8 Impact Bits and Sturdy Blow Mold Case



## Pocket Screwdrivers

### 6 Way Pen Screwdriver, 4 Pack

SKU 1368633 22537 **19.99**

- 6 Precision Drivers in One Handy, Pocket Size Tool
- 2 Double End Phillips and Slotted Screwdriver Bits
- #0 and 1/8", #1 and 5/32" Double End Bits
- Perfect for Small Parts and Assembly Tasks



OEM TOOLS®

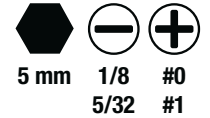

## Triple Square Bit Sets

- Use on European Vehicles Like BMW, Mercedes, VW, Audi and Porsche
- Heat-Treated Alloy Steel Bits to Reduce Premature Wear
- Reinforced Chrome Vanadium Steel Sockets to Increase Turning Power
- Fully Refined Hard Chrome Plated Finish and Zinc Phosphate Bits Treatment to Prevent Rust and Corrosion
- Meets and Exceeds ANSI Standards

OEM TOOLS®

### 10 Piece Extra Long XZN Triple Square Spline Bit Socket Set

SKU 1368626 23519 **34.99** REG. \$44.99

- Sizes Included: M4, M5, M6, M8, M9, M10, M12, (Tamper-Proof) M14, M16, M18
- Socket Length: 3.93"

SAVE \$10



Offer Good Through March 31, 2025

### 10 Piece Magnetic Long Triple Square Bit Socket Set

SKU 1313567 23907 **44.99**

- Sizes Included: (1/4" Drive) M4, M5, M6; (3/8" Drive) M8, M9, M10, M12, M14; (1/2" Drive) M16, M18
- Socket Length: 3.93"



### 9 Piece Triple Square Bit Set

SKU 191052 25953 **19.99**

- 1/4" Drive: M4, M5 and M6 (Length: 37 mm)
- 3/8" Drive: M8, M10 and M12 (Length: 48 mm)
- 1/2" Drive Tamper-Proof: M14, M16 and M18 (Length: 55 mm)



### 10 Piece Triple Square Bit Socket Set

SKU 1368630 22711 **29.99**

- Sizes Included: M4, M5, M6, M8, M9, M10, M12, (Tamper-Proof) M14, M16, M18
- Comes Enclosed in Blow Mold Case for Easy Identification and Storage



### 10 Piece Magnetic Triple Square Bit Socket Set

SKU 1368615 23906 **29.99**

- Powerful Magnetic Bits to Prevent the Loss of Nuts, Bolts and Fasteners
- Comes Enclosed in Blow Mold Case for Easy Identification and Storage
- Sizes Included: (1/4" Drive) M4, M5, M6; (3/8" Drive) M8, M9, M10, M12, M14; (1/2" Drive) M16, M18



Prices subject to change without notice. Prices do not include applicable taxes, vehicles, tires, rims, installation or optional equipment as shown. Please do not return purchases to the store. For information regarding warranty, repair, or any questions or concerns, call 901-300-4878.

# HAND TOOLS

- Constructed for Professionals with Superior Materials for Increased Torque and Hardness
- Heat-Treated S2 Steel Bits to Reduce Premature Wear

- Reinforced Chrome Vanadium Steel Sockets for Durability and Improved Finish
- Fully Refined Hard Chrome Plated Finish and Zinc Phosphate Bits Treated to Prevent Rust and Corrosion

**OEM TOOLS®**

## Hex Sets

### 12 Piece Magnetic (SAE)

SKU 1282759  
23900 **24<sup>99</sup>** REG. \$34.99

- 1/4" Drive: 1/16", 5/64", 3/32", 7/64" and 1/8"
- 3/8" Drive: 9/64", 5/32", 3/16", 7/32", 1/4", 5/16" and 3/8"

### 12 Piece Magnetic (Metric)

SKU 1282804  
23901 **24<sup>99</sup>** REG. \$34.99

- 1/4" Drive: 2 mm, 2.5 mm, 3 mm, 4 mm, 5 mm and 5.5 mm
- 3/8" Drive: 6 mm, 7 mm, 8 mm, 9 mm, 10 mm and 12 mm

### 12 Piece Magnetic Long (SAE)

SKU 1282807  
23902 **34<sup>99</sup>** REG. \$44.99

- 1/4" Drive: 1/16", 5/64", 3/32", 7/64", 1/8"
- 3/8" Drive: 9/64", 5/32", 3/16", 7/32", 1/4", 5/16" and 3/8"

### 12 Piece Magnetic Long (Metric)

SKU 1282737  
23903 **34<sup>99</sup>** REG. \$44.99

- 1/4" Drive: 2 mm, 2.5 mm, 3 mm, 4 mm and 5 mm
- 3/8" Drive: 5.5 mm, 6 mm, 7 mm, 8 mm, 9 mm, 10 mm and 12 mm

Offers Good While Supplies Last Through March 31, 2025

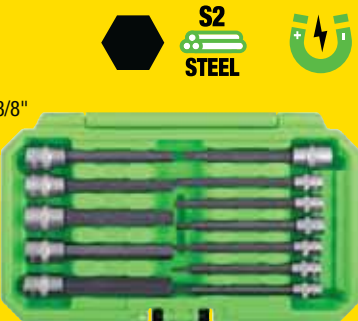
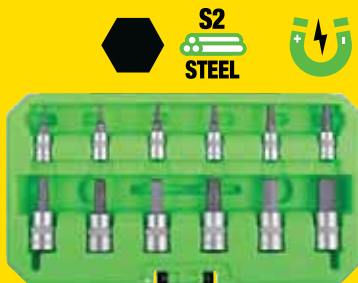

### 12 Piece Long (SAE)

SKU 1282747  
23563 **29<sup>99</sup>** REG. \$34.99

- 1/4" Drive: 1/16", 5/64", 3/32", 7/64" and 1/8"
- 3/8" Drive: 9/64", 5/32", 3/16", 7/32", 1/4", 5/16" and 3/8"

### 12 Piece Long (Metric)

SKU 1282757  
23538 **29<sup>99</sup>** REG. \$34.99

- 1/4" Drive: 2 mm, 2.5 mm, 3 mm, 4 mm and 5 mm
- 3/8" Drive: 5.5 mm, 6 mm, 7 mm, 8 mm, 9 mm, 10 mm and 12 mm

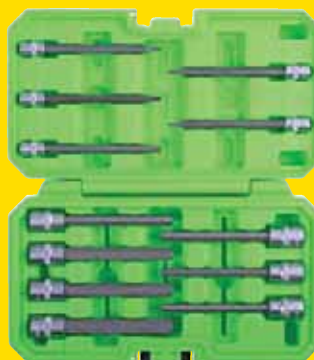

Offers Good Through March 31, 2025

### 32 Piece Hex Bit Socket Set (SAE and Metric)

SKU 1282740  
22989 **39<sup>99</sup>**

#### SAE

- 1/4" Drive: 1/8", 5/32", 3/16", 7/32" and 1/4"
- 3/8" Drive: 9/32", 5/16", 3/8", 7/16" and 1/2"
- 1/2" Drive: 9/16", 5/8", 11/16" and 3/4"

#### Metric

- 1/4" Drive: 2, 2.5, 3, 4, 5, 5.5 and 6 mm
- 3/8" Drive: 7, 8, 9, 10 and 12 mm
- 1/2" Drive: 14, 15, 17 and 19 mm



### 26 Piece Master Hex Bit Set

SKU 802219  
23990 **46<sup>99</sup>**

- Includes: 1/4" Drive Sizes: 1/8" to 7/32" and 2.5 to 5 mm, 3/8" Drive Sizes: 1/4" to 11/32" and 6 to 9 mm, 1/2" Drive Sizes: 3/8" to 5/8" and 10 to 19 mm



### 1/2" Drive Hex Bit Set (Metric)

SKU OUTSIDE BUY/EPO  
25417 **14<sup>99</sup>**

- Sizes: 12, 14 and 17 mm
- Use on Transmission and Differential Drain Plugs

For Outside Buy/EPO,  
Call 901-300-4878



### 7 Piece Hex Bit Set (SAE)

SKU 127904  
22982 **24<sup>99</sup>**

- 3/8" Drive: 5/16" and 3/8"
- 1/2" Drive: 7/16", 1/2", 9/16", 5/8" and 3/4"



### 1/2" Drive Metric Hex Bit Socket Set (7 Piece)

SKU 1168830  
22998 **29<sup>99</sup>**

- Includes: 13, 14, 15, 17, 19, 21 and 22 mm



### 9 Piece Hex Bit Set (Metric)

SKU 127903  
22983 **29<sup>99</sup>**

- Includes: 1/4" Drive 2, 2.5, 3, 4 mm and 3/8" Drive 5, 6, 7, 8, 10 mm
- Knurling Position is Optimized for Best Finger Gripping Position



### 1/2" Drive SAE Hex Bit Socket Set (6 Piece)

SKU 1168826  
22999 **24<sup>99</sup>**

- Includes 9/16", 5/8", 11/16", 3/4", 13/16" and 7/8"
- Tempered Chrome Vanadium Steel with a Plated Finish for Long Life



### 12 Piece Hex Bit Set (SAE)

SKU 127905  
22984 **27<sup>99</sup>**

- Includes: (1/4" Drive) 1/16", 5/64", 3/32", 7/64", 1/8"; (3/8" Drive) 9/64", 5/32", 3/16", 7/32", 1/4", 5/16", 3/8"
- Knurling Position is Optimized for Best Finger Gripping Position



## Multi-Drive Sets

### 35 Piece Multi-Drive Star Socket Set

SKU 802217  
23991 **49<sup>99</sup>**

- 1/4" Drive Star: T10, T15, T20, T25, T27 and T30
- 1/4" Drive Tamper-Proof Star: T7, T8, T9, T10, T15, T20, T25 and T30
- 1/4" Drive Female Star: E4, E5, E6, E7 and E8
- 3/8" Drive Tamper-Proof Star: T40, T45, T50 and T55
- 3/8" Drive Star: T40, T45, T47, T50 and T55
- 3/8" Drive Female Star: E10, E12, E14 and E16
- 1/2" Drive Star: T60 and T70
- 1/2" Drive Female Star: E18



10-3/4" Width x 5-3/4" Depth

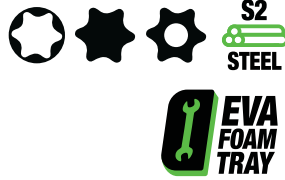

### 44 Piece Multi-Drive Star and Bit Socket Set

SKU 802206  
23992 **54<sup>99</sup>**

- 1/4" Bit Holder
- 1/4" Hex Drive Tamper-Proof Star Bits: T7, T8, T9, T10, T15, T20, T25, T27, T30
- 1/4" Hex Drive Star: T10, T15, T20, T25, T27 and T30
- 3/8" Drive Star: T40, T45, T47, T50, T55 and T60
- 3/8" Drive Metric Hex: 2, 2.5, 3, 4, 5, 6, 7, 8 and 10 mm
- 3/8" Drive SAE Hex: 1/8", 5/32", 3/16", 7/32", 1/4", 5/16" and 3/8"
- 3/8" Drive Phillips: #1, #2 and #3
- 3/8" Drive Slotted: 3/16", 1/4" and 5/16"



10-3/4" Width x 5-3/4" Depth



## Star Sets

### 13 Piece Tamper-Proof

SKU 1282735  
22710 **19<sup>99</sup>** REG. \$24.99

- 1/4" Drive: T8, T10, T15, T20, T25, T27 and T30
- 3/8" Drive: T40, T45, T47, T50 and T55
- 1/2" Drive: T60

**SAVE \$5**



Offers Good While Supplies Last Through March 31, 2025

### 13 Piece Star Bit Socket Set

SKU 1282806  
22977 **19<sup>99</sup>** REG. \$24.99

- 1/4" Drive: T8, T10, T15, T20, T25, T27 and T30
- 3/8" Drive: T40, T45, T47, T50 and T55
- 1/2" Drive: T60



### 35 Piece Master Star Bit Set

SKU 466622  
25951 **49<sup>99</sup>**

- 1/4" Drive Star: T8 to T30
- 1/4" Drive Tamper-Proof Star: T7, T8, T9, T10, T15, T20, T25 and T30
- 1/4" Drive Female Star: E4, E5, E6, E7 and E8
- 3/8" Drive Star: T40, T45, T47, T50 and T55
- 3/8" Drive Tamper-Proof Star: T40, T45, T50 and T55
- 3/8" Drive Female Star: E10, E12, E14 and E16
- 1/2" Drive Star: T60



### 11 Piece Tamper-Proof Star Set

SKU 127872  
22972 **19<sup>99</sup>** REG. \$25.99

- Includes: (1/4" Drive) T8, T10, T15, T20, T25, (3/8" Drive) T27, T30, T40, T45, T47, T50
- Knurling Position is Optimized for Best Finger Gripping Position
- Black Oxide Finish Indicates Star Drivers

**SAVE \$6**



Offer Good While Supplies Last Through March 31, 2025

### 12 Piece Tamper-Proof Star Set

SKU 127870  
22971 **29<sup>99</sup>**

- Includes: (1/4" Drive) T8 to T25; and (3/8" Drive) T27 to T55
- Knurling Position is Optimized for Best Finger Gripping Position -- Go Ahead and Put On Serious Torque, it Won't Slip
- Black Oxide Finish Indicates Star Drivers
- Chamfered Ends Allow the Socket to Easily Slip Over the Bolt Head
- Makes Fastener Engagement Quick and Smooth



### 13 Piece Magnetic

SKU 1267957  
23904 **34<sup>99</sup>**

- 1/4" Drive: T8, T10, T15, T20, T25, T27 and T30
- 3/8" Drive: T40, T45, T47, T50, T55 and T60



### 13 Piece Magnetic Long

SKU OUTSIDE BUY/EPO  
23905 **34<sup>99</sup>** REG. \$44.99

- 1/4" Drive: T8, T10, T15, T20, T25, T27 and T30
- 3/8" Drive: T40, T45, T47, T50, T55 and T60



For Outside Buy/EPO, Call 901-300-4878

Offers Good While Supplies Last Through March 31, 2025

### 13 Piece Extra Long

SKU 1282758  
23680 **39<sup>99</sup>** REG. \$49.99

- 1/4" Drive: T8, T10, T15, T20, T25, T27 and T30
- 3/8" Drive: T40, T45, T47, T50, T55 and T60



**SAVE \$10**

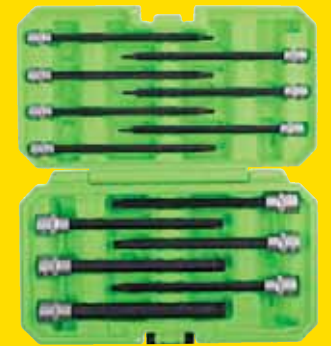

Ratchet Not Included

### Stubby Star Drive Sets

SKU 447157  
24293 **29<sup>99</sup>**

- 1/4" Drive: T7, T8, T9, T10, T15, T20, T25, T27, T30, T40, T45, T47 and T50



### 13 Piece Tamper-Proof

SKU 447156  
24294 **29<sup>99</sup>**

- 1/4" Drive: T7H, T8H, T9H, T10H, T15H, T20H, T25H, T27H, T30H, T40H, T45H, T47H and T50H



# HAND TOOLS

## Pro Series Pliers Sets

OEM TOOLS

### 3 Piece Groove Joint Pliers Set

SKU 662761  
22648 **39<sup>99</sup>** REG. \$49.99

- Sizes: 8", 10" and 12"
- Gripping Capacity: 8" (1.25"), 10" (1.80"), 12" (2.25")

**SAVE \$10**



Offer Good Through March 31, 2025

### 3 Piece Mechanics Pliers Set

SKU 662748  
22647 **44<sup>99</sup>**

- Pliers and Sizes: 7" Diagonal Pliers, 8" Linesman Pliers, and 10" Speed-Fit Pliers



## Locking Pliers

OEM TOOLS

- For Clamping and Gripping in Tight Spaces
- Constructed with Heat-Treated Alloy Steel
- Precision-Machined Jaws Feature Hardened Teeth to Provide a Sure Grip from Any Angle
- Instant Locking and Release Mechanism for Improved Control
- Nickel Chrome Plated to Resist Rust

### 7 Piece Locking Pliers Set

SKU 012622  
23987 **89<sup>99</sup>**

- Sizes: 4", 5", 7", 10" Curved Jaw and 4", 6", 9" Long Nose

EVA  
FOAM  
TRAY



15" Width x 10" Depth

#### Curved Jaw



22635

#### Long Nose



22637

#### Chain



22642

SKU	Part #	Type	Size	Price
81256	22635	Curved Jaw	4"	<b>7.99</b>
81261	22638		7"	<b>12.99</b>
81263	22640		10"	<b>18.99</b>
81260	22637	Long Nose	6-1/2"	<b>9.99</b>
81262	22639		9"	<b>12.99</b>
81267	22642	Chain	19"	<b>19.99</b>

## Extended Reach Pliers

OEM TOOLS

### 11" Long Reach Long Nose Pliers

TECREADY  
GRIPS

- Constructed with Durable Heat-Treated Alloy Steel
- Precision-Machined Jaws Provide Improved Grip
- TecReady Grip Handles Reduce User Fatigue
- Nickel Chrome Plated to Resist Rust

#### Straight

SKU 081249  
22621 **15<sup>99</sup>**



#### 45°

SKU 081250  
22622 **15<sup>99</sup>**



#### Duck Bill

SKU 213108  
22644 **15<sup>99</sup>**



(Color May Vary)

## Diagonal Pliers

### 6-1/2" High Leverage Diagonal Pliers

SKU 081240  
22614 **12<sup>99</sup>**

- High Leverage Design for Gripping, Bending and Cutting Tasks



OEM TOOLS

TECREADY  
GRIPS

## X-Type Pliers

OEM TOOLS

### 2 Piece 13" Long Nose Pliers Set

SKU 213127  
22632

- Includes: 45° and Straight Extended Reach Pliers

Xtype  
Pliers

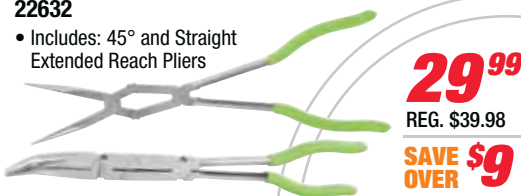

**29<sup>99</sup>**  
REG. \$39.98

**SAVE \$9  
OVER**

When You Buy the Set

### 13" Long Nose Pliers

- Serrated Jaws for Precision Gripping

#### Straight

SKU 213135  
22633 **19<sup>99</sup>**

#### 45°

SKU 213117  
22634 **19<sup>99</sup>**



## Mechanic's Pliers

OEM TOOLS

- Precision-Machined Jaws Provide Improved Grip
- TecReady Grip Handles Reduce User Fatigue
- Nickel Chrome Plated to Resist Rust

#### Diagonal Pliers

- High Leverage Design for Gripping, Bending and Cutting Tasks



#### Linesman Pliers

- Designed for Gripping, Twisting, Bending and Cutting Wire and Cable



#### Groove Joint Pliers

- Adjustable Jaw Provides Gripping Power for Turning Irregularly Shaped Objects, Nuts and Bolts



#### Long Nose Pliers with Side Cutter

- For Powerful Gripping and Cutting in Hard-to-Reach Spaces



SKU	Part #	Type	Size	Price
081241	22615	Diagonal	7-1/2"	<b>17.99</b>
081245	22617	Groove Joint	6"	<b>16.99</b>
081246	22618		8"	<b>18.99</b>
081247	22619		10"	<b>19.99</b>
081248	22620		12"	<b>21.99</b>
081252	22624		16"	<b>24.99</b>
081243	22616	Linesman	8"	<b>18.99</b>
081237	22612	Long Nose Pliers with Side Cutter	6"	<b>16.99</b>
081239	22613		8"	<b>18.99</b>



# HAND TOOLS

TO ORDER, contact your Commercial Sales Manager or go to [AutoZonePro.com](http://AutoZonePro.com)

HAND TOOLS

## Punch Set

OEM TOOLS®

### 16 Piece Punch and Chisel Set

SKU 914624 **29<sup>99</sup>** REG. \$34.99  
25515 **SAVE \$5**

- Includes: 5 Taper Punches, 5 Pin Punches, 2 Center Punches, 3 Cold Chisels and 1 Chisel Gauge



Offer Good Through March 31, 2025

## Pry Bars

OEM TOOLS®

### 3 Piece Light Duty Smoothing/Prying Kit

SKU 004111 **22<sup>99</sup>**  
25084

- Pry Dashboard Parts and Vents without Damaging Interior
- Clean Crevices and Joints in Small Electronics
- Disassemble Key Fobs and Other Remotes
- Evenly Smooth Epoxy and Adhesives



## 3 Piece Pry Bar Set

OEM TOOLS®

SKU 626114 **39<sup>99</sup>**  
24433

- Lengths Included: 12", 18" and 24"
- 3 Sided Handle for Secure Grip and Comfort
- Solvent Resistant and Easy to Clean



## Dead Blow Hammers

OEM TOOLS®

### 3 Piece Dead Blow Hammer Set

SKU 900804 **27<sup>99</sup>** REG. \$32.99  
25517 **SAVE \$5**

- Soft Rubber Handles for Non-Slip Grip
- Steel Shot Filled for More Force
- Non-Spark Material Used



Offer Good Through March 31, 2025

## 36" Pry Bar

SKU 695126 **35<sup>99</sup>**  
24435

- Unique Ergonomically Designed 3-Sided Handle for Secure Grip and Comfort
- Handles Made with Hardened Resin That is Solvent Resistant and Easy-to-Clean
- Forged and Hardened 5/8 In. Square Stock for Incredible Strength



OEM TOOLS®

## Adjustable Wrenches

OEM TOOLS®

- Made with Special Alloy Steel, Heat-Treated
- Deep Marking for Easy Identification
- Nickel Chrome Plated Steel Won't Rust
- Flat Profile is Comfortable in Hands



SKU	Part #	Size	Price
081268	22650	4"	<b>9.99</b>
081269	22651	6"	<b>11.99</b>
081271	22652	8"	<b>13.99</b>
081273	22653	10"	<b>15.99</b>
081274	22654	12"	<b>17.99</b>
081297	22655	15"	<b>21.99</b>

## Pipe Wrench

GreatNeck

- Precision Milled Moveable Jaws
- Perfectly Balanced



SKU	Part #	Material	Size	Price
965845	APW14	Aluminum	14"	<b>29.99</b>
965848	APW18		18"	<b>59.99</b>
972768	APW24		24"	<b>59.99</b>
965847	APW36		36"	<b>69.99</b>
965846	PW24	Steel	24"	<b>44.99</b>

## Pick-Up Tool

OEM TOOLS®

### Heavy Duty Telescopic Magnetic Pick-Up Tool

SKU 231205 **16<sup>99</sup>**  
25466

- Lifts Up to 3 Lb.
- Telescoping Handle Range: 6" to 33"



## Cutting Tools

### Folding Lock Back® Utility Knife with Blade Dispenser

SKU 1022296 **14<sup>99</sup>**  
25537

- Includes: Blade Dispenser with 50 Blades
- Extra-Wide Handle for Increased Comfort and Leverage



### Premium Folding Lock Back® Utility Knife with Sheath

SKU 1142419 **19<sup>99</sup>**  
12818

- 3-1/2" Stainless Steel and Hardwood Handle
- Patented Quick-Change Mechanism
- Accepts All Standard Utility Blades
- Includes: 1 Blade and Leather Sheath with Pocket Clip



### 4 Piece Plastic Scraper Set

SKU 900802 **19<sup>99</sup>**  
25513

- Works Like a Chisel
- Will Not Scratch Paint
- Will Not Cause Sparks
- Can Be Used for Wheel Weight Removal

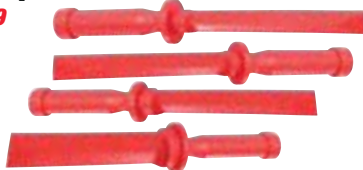

OEM TOOLS®



### 10" Utility Scissors

SKU 1142911 **15<sup>99</sup>**  
25085

- Super Hard Diamond-Like Carbon (DLC) Coating
- Stainless Steel Construction for Strength and Durability
- Bolt Lock Keeps Blades Secure
- Full Length Metal Frame Extends Through Handle for Added Strength



### Scraper Kit

SKU 1282744 **19<sup>99</sup>**  
69004

- Includes: 2 Packs of Razor Blades (200) and 1 Razor Blade Scraper
- Perfect for Removing Paint and Decals



**19<sup>99</sup>** REG. \$38.97  
**SAVE OVER \$18**  
When You Buy the Kit

### Moab Auto Emergency Folding Pocket Knife

SKU 1142700 **24<sup>99</sup>**  
12870

- 3-5/16" Partially Serrated Stainless Steel Blade, 4-1/2" Folded
- One-Handed Opening Mechanism
- Liner Lock
- Glass Breaker
- Belt Cutter
- Pocket Clip
- 4.5 Oz.
- Lifetime Warranty



Prices subject to change without notice. Prices do not include applicable taxes, vehicles, tires, rims, installation or optional equipment as shown. Please do not return purchases to the store. For information regarding warranty, repair, or any questions or concerns, call 901-300-4878.

# HAND TOOLS

## Precision Drivers

- Precision Driver Sets for Electronics and Applications in Tight Spaces
- Magnetic Tips to Secure Fasteners
- Constructed with Durable Chrome Vanadium Steel

**SAVE \$5**

### 7 Piece Metric Nut Driver Set

SKU 1282732 22562 **24<sup>99</sup>** REG. \$29.99

- Includes: 3.0, 3.5, 4.0, 4.5, 5, 5.5 and 6.0 mm

### 7 Piece Metric Hex Driver Set

SKU 1282731 22563 **24<sup>99</sup>** REG. \$29.99

- Includes: 0.7, 0.9, 1.3, 1.5, 2.0, 2.5 and 3.0 mm

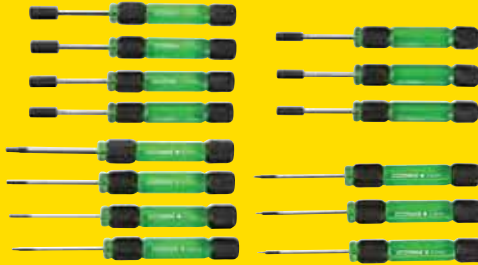

Offers Good Through March 31, 2025

## 6 Piece Precision Screwdriver Set

- Constructed with Durable Chrome Vanadium Steel

**OEM TOOLS**

### Star Screwdriver Set

SKU 003763 22559 **14<sup>99</sup>**

- Set Includes: T5, T6, T7, T8, T9 and T10

### Screwdriver Set

SKU 003751 22560 **14<sup>99</sup>**

- Slotted Screwdrivers: (1.4, 2, 2.4 and 3 mm)
- Phillips Screwdrivers: (#0 and #1)

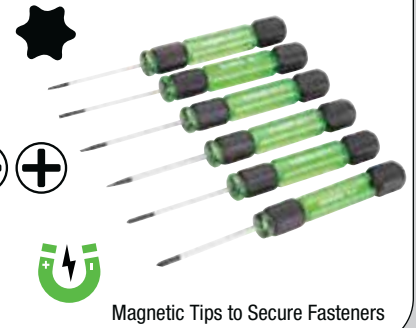

Magnetic Tips to Secure Fasteners

## Picks

### 4 Piece 14" Jumbo Pick Set

SKU 094658 25940

**29<sup>99</sup>**

REG. \$34.99

- Includes: Straight, 90°, Offset and Hook Pick

**SAVE \$5**

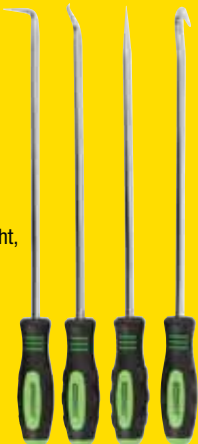

Offer Good Through March 31, 2025

### 8 Piece Combination Hook and Pick Set

SKU 1168660 68913 **19<sup>99</sup>**

- Set Includes: 4 Pc. 8" Hook and Pick Set with Acetate Handle and 4 Pc. 6" Mini Hook and Pick Set with Cushion Grip



### 6 Piece 8" Hook and Pick Set

SKU 1207883 26545 **16<sup>99</sup>**

- Set Includes: 1 Hook Pick, 1 Complex Pick, (1) 90° Pick, 1 Combination Pick, 1 Double Angle Pick, 1 Straight Pick



### 8 Piece 10" Cushion Hook and Pick Set

SKU 1207881 26526 **14<sup>99</sup>**

- Set Includes: Hook Pick, 90° Pick, 45° Pick, Double Angle Pick, Complex Pick, Angle Hook Pick, Combination Pick and a Straight Pick



## Safety Wire Pliers

### Reversible Wire Twister Pliers

**Includes: 10 Meter x 0.5 mm Wire**

- Heavy Duty Construction with Automatic Spring Return
- Reversible Action for Left and Right Twisting
- Locking Jaws for Superior Wire Twisting
- Forged High Carbon Diamond Grooved Jaws to Cut and Grip Stainless Wire



6" and 9" SKU 1282746 22663

**99<sup>99</sup>**

9" SKU 1362002 22662

**69<sup>99</sup>**

6" SKU 1282736 22661

**49<sup>99</sup>**

REG. \$59.99 Offer Good Through March 31, 2025

**SAVE \$10**

## Specialty Wrenches

### Adjustable Gland Nut Wrench

- For Hydraulic Cylinders with Gland Nuts
- Reversible Design



SKU 1207900 27398 **26<sup>99</sup>**

- Range: 1" to 3.75"
- Pin Size: 7/32" and 1/4"
- Drive: 1/2"

SKU 1340231 27397 **34<sup>99</sup>**

- Range: 2" to 6"
- Pin Size: 1/4" and 5/16"
- Drive: 3/4"

**OEM TOOLS**

## Hack Saw and Blade Packs

### Professional Hack Saw

SKU 1142352 74007 **11<sup>99</sup>**

- Includes (1) 12" 24 TPI Bi-Material Blade
- High Tension Blade Prevents Twisting to Ensure Straight, Fast Cut
- Ergonomic Comfort Grip on Front Frame and Handle Provides Two-Handed Control



### 12" Hacksaw Blade (10 Pack)

SKU 1142562 74014 **14<sup>99</sup>**

### Bi-Metal Hacksaw Blades Assorted (10 Pack)

SKU 1142672 74016 **15<sup>99</sup>**

- Includes: 18 TPI (x3), 24 TPI (x4) and 32 TPI (x3)



**GreatNeck**

## Nut Drivers

### 7 Piece Professional Nut Driver Set

- Chrome Vanadium Steel for Strength and Durability
- Highest Quality Acetate Handle Stands Up to Abuse
- Color Coded for Easy Identification



### Metric

SKU 949001 ND71 **22<sup>99</sup>**

- Sizes: 6, 7, 8, 9, 10, 11 and 12 mm

### SAE

SKU 949002 ND72 **22<sup>99</sup>**

- Sizes: 3/16", 1/4", 5/16", 11/32", 3/8", 7/16" and 1/2"

**GreatNeck**

# THREAD REPAIR

TO ORDER, contact your Commercial Sales Manager or go to [AutoZonePro.com](http://AutoZonePro.com)

THREAD REPAIR

## Ford Triton Repair Kits

### Ford Triton 2 Valve Cylinder Repair Set

SKU 1268421 **369<sup>99</sup>**  
CAL38900

- Quality Foolproof Repair System That is Cost-Effective and Fast
- High-Quality Oversized Steel Alloy Insert Will Repair Other Inserts That Fail
- Application: 1996 to 2003 Ford 4.6L, 5.4L and 6.8L Engines



### Ford 2 Valve Insert

SKU 1268420 **34<sup>99</sup>**  
CAL389-100

- Designed to Aid in Repairing 1996-2003 Two Valve Ford Modular Cylinder Heads
- High Quality Oversized Steel Alloy Insert Will Repair Other Inserts That Fail

### Ford Triton 3 Valve Set

SKU 343388 **329<sup>99</sup>**  
CAL39300

- Application: 2004 to 2008 Ford 4.6 and 5.4 3 Valve Engines with Spark Plugs That are M16 x 1.5
- Includes 8 Inserts



### M16 x 1.5 3 Valve Insert

SKU 396658 **24<sup>99</sup>**  
CAL393-100

- Note: this is NOT the Replacement Insert for the Triton 2 Valve Kit



### Ford Triton Spark Plug and Electrode Repair Set

SKU 1268418 **99<sup>99</sup>**  
CAL39500

- Extracts the Broken Porcelain or Seized Sleeves from Broken Spark Plugs in 2003 to Current Ford Triton Engines



### Ford Triton Plug-Saver® Kit

SKU 094873 **124<sup>99</sup>**  
FIX98140T

- Designed to Specifically Repair the Spark Plug Ports in 4.6, 5.4 and 6.8 Ford Triton Engines
- Repairs Worn, Damaged Threads
- Includes: Self Cutting Tap, Tool and 8 Inserts in a Sturdy Case



### Inserts (Pack of 8)

SKU 110263 **39<sup>99</sup>**  
FIX98149P

### Broken Spark Plug Remover Ford Triton 3 Valve

SKU 489173 **119<sup>99</sup>**  
LIS65600

- Includes a Unique Porcelain Pusher Tool and a Tapered Left-Hand Thread Remover for Removing the Broken Spark Plug without Leaving the Porcelain in the Engine Cylinder



## Oxygen Sensor Thread Repair

### Oxygen Sensor Thread Repair Kit

SKU 010134 **134<sup>99</sup>**  
FIX38189-1

- No Need to Replace Exhaust Manifold
- Pilot Nose Tap Provided



## Wheel Stud Cleaner

### Quick Change Wheel Stud Cleaner Kit

SKU 666299 **69<sup>99</sup>**  
CAL16

- Kit Includes: 1/2" Drive Adapter and 6 Brushes
- Brush Sizes: 7/16" (12 mm), 1/2" (13 mm), 9/16" (14 mm), 5/8" (16 mm), 7/8" (22 mm) and 1-1/8" (28 mm)



## Head Bolt Thread Repair

### Metric Head Bolt Thread Repair Kit

SKU 010131 **149<sup>99</sup>**  
FIX35119S

- Extended Reach for Deep Threads
- Longer Length (33 x 1.5 mm) Inserts for Maximum Thread Engagement
- Applications: Cadillac, Honda, Toyota and Other Imports That Use M11 x 1.5 Head Bolts



## Nut Busting Bolt Extractors

### 9 Piece (Metric)

SKU 751718 **24<sup>99</sup>**  
22967

- Includes: 8 mm, 10 mm, 11 mm, 12 mm, 13 mm, 14 mm, 16 mm, 17 mm and 19 mm



### Nut Busting Bolt Extractor Socket Sets

- High Visibility Markings for Fast, Easy Socket Selection
- Chrome-Molybdenum Steel Construction for Maximum Durability
- 3/8" Drive



Specialized Design for a Secure Universal Grip



### 9 Piece (SAE)

SKU 751720 **24<sup>99</sup>**  
22968

- Includes: 1/4", 5/16", 3/8", 7/16", 1/2", 9/16", 5/8", 11/16" and 3/4"



Prices subject to change without notice. Prices do not include applicable taxes, vehicles, tires, rims, installation or optional equipment as shown. Please do not return purchases to the store. For information regarding warranty, repair, or any questions or concerns, call 901-300-4878.

# THREAD REPAIR

## Spiral Bolt Extractor Sets

- Made of High-Quality Chrome Molybdenum Steel for Durability
- Grips and Removes a Wide Range of Stubborn Fasteners
- 3/8" Drive



**Bites into Rusted, Rounded and Painted Over Nuts and Bolts**

Drill Not Included



**Specialized Spiral Design for a Secure Universal Grip on Nuts and Bolts**

## 3/8" Drive 18 Piece Impact Extractor Set

SKU 1361992 **49<sup>99</sup>**  
23700

- Sizes Include: 7 mm, 5/16" (8 mm), 9 mm, 3/8", 10 mm, 7/16" (11 mm), 12 mm, 1/2", 3 mm, 14 mm, 9/16", 5/8" (16 mm), 17 mm, 11/16", 3/4" (19 mm), 1/4" Hex Adapter and Knockout Pin

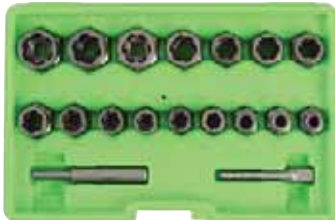

## 5 Piece Spiral Type Deep Extractor Set on Aluminum Rail

SKU OUTSIDE BUY/EPO **38<sup>99</sup>**  
22993

- Specialized Spiral Design for a Secure Universal Grip
- Chrome Vanadium Steel Construction for Maximum Durability
- Sizes: 3/8" (10 mm), 7/16" (11 mm), 1/2" (13 mm), 9/16" (14 mm) and 5/8" (16 mm)



For Outside Buy/EPO, Call 901-300-4878

## 10 Piece Spiral Type Bolt Extractor Set on Aluminum Rail

SKU 081788  
22988

**39<sup>99</sup>** REG. \$49.99

**SAVE \$10**

- Sizes: 5/16" (8 mm), 3/8", 10 mm, 7/16" (11 mm), 13 mm, 11/16", 1/2" (13 mm), 9/16" (14 mm), 3/4" (19 mm) and 5/8" (16 mm)
- 3/8" Drive

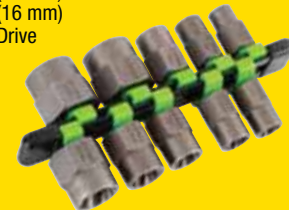

Offer Good Through March 31, 2025

## Drain Plug Repair

### Drain Plug Repair Kit

SKU 818569 **99<sup>99</sup>**  
CAL38400

- Designed to Repair Aluminum Oil Pans with Damaged Drain Plug Threads, Size M12 x 1.75 Commonly Found in GM, Ford and Mazda Vehicles
- Includes: Drill, Counter Bore, Tap, Driver, Guide and (5) 12 mm Inserts
- Allows Use of OEM Plug Instead of an Oversize Replacement



### Oil Pan Rethreading Kit

SKU 751709 **149<sup>99</sup>**  
LIS58850

- Oil Pan Plug Rethreading Kit Works on Steel or Aluminum Pans 1/2", 12 mm and 14 mm Threads



## Axle Spindle Thread Repair

### Axle Spindle Threading Set

SKU 1103645 **49<sup>99</sup>**  
37233

- Used to Clean or Repair Axle Threads
- Set Comes with a Special Twist Shape That Provides Easier and Quicker Work
- Sizes Included: M20 x 1.25, M20 x 1.50, M22 x 1.00, M22 x 1.50, M24 x 1.50, M24 x 2.00, 13/16" x 20 UNEF, 3/4" x 20 UNEF and 27 mm Extension Bar



## Screw Extractor Bits

### 10 Piece Spiral Extractor and Drill Bit Combo Pack

SKU 099229 **19<sup>99</sup>**  
24373

- Extractors: Ex-1, Ex-2, Ex-3, Ex-4 and Ex-5
- Left Hand 135° Split Point Cobalt
- Drill Bit Sizes: 5/64", 7/64", 5/32", 1/4" and 19/64"
- Pilot Point Starts on Contact and Eliminates Bit Walking
- Comes in a Vinyl Pouch



### 6 Piece Spiral Flute Screw Extractors Set

SKU 099277 **14<sup>99</sup>**  
24374

- Extractors: Ex-1, Ex-2, Ex-3, Ex-4, Ex-5 and Ex-6
- Comes in a Vinyl Pouch



### 4 Piece Damaged Screw Extractor Set

SKU 081310 **9<sup>99</sup>**  
25158

- Used to Quickly Remove Stripped, Broken and Painted Over Screws
- Will Work with Phillips, Flathead, Hex and Other Common Screws



### 35 Piece Master Screw Extractor/Drill Bit Set

SKU 099258 **89<sup>99</sup>** Reg. \$99.99  
24377

**SAVE \$10**

- Spiral and Multi-Spline Extractors for Removing the Toughest Bolts and Screws from 3/32" to 15/16"
- 135° Split Point Left Hand Cobalt Drill Bits
- Comes in a Foam-Lined Metal Case



Offer Good Through March 31, 2025

## Consumables

### Start-Up Kit (Dispenser and Product)

SKU 262544  
SNGMFKP994376  
**599<sup>99</sup>**

- Kit Includes: 250 Seat Covers
- 250 Paper Floor Mats
- 500 Plastic Floor Mats
- 500 Parts Bags
- 100 Tire Bags
- 1 Metal Floor Rack
- 1 Sign



**BONUS VALUE: \$64.99**

### Steering Wheel Cover

SKU 186485  
SNGMFBP994333 **74<sup>99</sup>**

### Steering Wheel Cover (500/Box)

- Double-Band Design Ensures a Snug Fit and Easy Installation



Vehicle Not Included

With Purchase of:  
SKU SNGMFKP994376  
**Offer Good While Supplies Last Through March 31, 2025**

### Plastic Write On Key Tag (1,000 Count)

- Self Locking Plastic Key Tags Help Secure Keys **29<sup>99</sup>**



**White**  
SKU 262547  
SNGMFBP993323

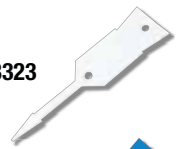

**Blue**  
SKU 1125872  
SNGFBP993398

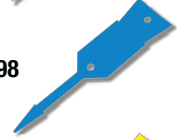

**Yellow**  
SKU 1125859  
SNGFBP993324

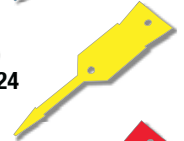

**Red**  
SKU 1125868  
SNGFBP993399



### Plastic Floor Mats (500/Box)

SKU 186488  
SNGMFGP994302 **74<sup>99</sup>**

- Roll Size: 16.5" x 21"
- Comes in Durable Self-Dispensing Box



### Paper Floor Mats (500/Box)

SKU 1151404  
SNGM371LCA500 **89<sup>99</sup>**

- Bright White Paper for Vibrant, Color Print
- Thank You Blue Imprinted LCA Image
- Plain Paper for Very Light Traffic
- Size Varies: 18.5" to 22"
- Standard Quality



### Disposable Seat Cover

- 2-Layer Construction Keeps Cover in Place
- Refill for Start-Up Kit

#### Premium (250/Roll)

SKU 262537  
SNGMFGP994314 **119<sup>99</sup>**

- .7 Mil Thick with the Dimensions of 32" x 56" Dispensing Box



#### Value (500/Roll)

SKU 186487  
SNGMFGP994315 **129<sup>99</sup>**

- .5 Mil Thick with the Dimensions of 32" x 52"

### Adhesive Floor Mats (175/Roll)

SKU 262546  
SNGMFBP993349  
**119<sup>99</sup>**

- Self Adhesive, 3 mil Protective Film Keeps Carpet Protected



### Work Ticket Holder (25/Box)

- Durable Brass Grommet Increases Strength
- Accommodates Most Pre-Printed and Computer Generated Forms

#### Clear

SKU 698887  
SNGFBP993302 **59<sup>99</sup>**

- 10.5" x 14.5" Clear Front and Back

#### Clear/Black

SKU 1142449  
SNGFBP993303 **59<sup>99</sup>**

- 11" x 13" Clear Front and Black Back



### Parts Bag 11" x 17" (500/Case)

SKU 262541  
SNGMFGP994330  
**49<sup>99</sup>**

- High Strength Protection
- Impervious to Most Shop Chemicals



Price Does Not Include Parts Shown

## Oil Change Labels

### Thermal Oil Change Sticker Printer

SKU OUTSIDE BUY/EPO  
SNGFKGX00106 **719<sup>99</sup>**

- Kit Includes: Printer, Keyboard, Power Cord/Adapter, 1 Ink Ribbon and 2 Rolls of 500 Generic Static Cling Labels



### Red Oil Can Service Reminder Labels

SKU 1405960  
SNGFB-P993345  
**39<sup>99</sup>**

- Replacement Roll of 500 Labels



### Blue Wrench Service Reminder Labels

SKU 1407511  
SNGFB-P993394  
**39<sup>99</sup>**

- Replacement Roll of 500 Labels



## Hand Cleaner



### World's Best Hand Cleaner

- Kit Includes: Wall-Mount Dispenser and 4,000 mL of Cherry Fragrance Cleaner
- All Natural, Concentrated, Solvent Free Cleansing Formula
- Unique Skin Conditioning System Leaves Hands Feeling Smoother, While Fibril Scrubbers Deep Clean Even the Toughest Dirt
- Cherry Fragrance Leaves Hands Smelling Great
- 100% Biodegradable

#### Starter Kit with Dispenser

SKU 972773  
24292 **64<sup>99</sup>**

#### 4000 mL Refill Bottle

SKU 972772  
24291 **44<sup>99</sup>**



## Tumbler



### 20 Oz. Stainless Steel Double Wall Tumbler

SKU 1392320  
26046 **14<sup>99</sup>**

- Keeps Drinks Cold for 24 Hours and Hot for 6 Hours
- Lid Made from Durable BPA-Free Plastic



For Outside Buy/EPO, Call 901-300-4878

# SHOP SUPPLIES

## Creepers

### Workshop Seat and Step Stool

SKU 1189077  
24904 **69<sup>99</sup>** REG. \$89.99

- Combination Step Stool and Creeper Seat That Allows Additional Maneuverability
- Thick Padding Covered with Durable Vinyl Provides Comfort While Working
- Includes a Tool Tray for Organization and Convenience
- 4 Swivel Casters Made for All Terrain
- Weight Capacity: 300 Lb.
- 18" (L) x 16" (W) x 7" (H)



Offer Good Through March 31, 2025

**SAVE \$20**

### Sidekick Creeper Stool

SKU 1168662  
24987 **124<sup>99</sup>**

- Large Open Tray to Carry a Wide Range of Items with Additional Holster Caddies on the Side for Rapid Access to Most Used Items
- Slide Out Under Seat Drawer Can Be Used to Store and Organize Tools
- Weight Capacity: 330 Lb.



### Heavy Duty Rolling Workbench and Creeper Seat

SKU 1142423  
24986 **89<sup>99</sup>**

- Molded Seat and Frame Provide Durable Support
- Removable Clip-In Trays for Storage and Easy Transport of Parts and Tools
- Trays Feature Screwdriver Storage Holes for Easy Organization
- Weight Capacity: 300 Lb.



### Cushioned Creeper Seat with Tool Tray

SKU 757019  
24948 **49<sup>99</sup>**

- Tool Tray Dimensions: 11-1/2" x 12-1/2"
- Cushioned Seat
- 4 Swivel, Oil-Resistant Wheels
- Weight Capacity: 330 Lb.



## Creepers

### Mechanics Creepers with Headrest

- Made with HDPE Plastic and Molded for Comfort to Ensure a Quick and Accurate Job
- Easy to Handle, Lift and Store
- 6 Swivel Casters Able to Maneuver All Terrain
- Casters are 3" in Diameter for Additional Durability and Product Longevity
- Weight Capacity: 350 Lb.

Offers Good Through March 31, 2025

40"  
SKU 1189063  
24909

**44<sup>99</sup>** REG. \$54.99  
• Light Weight 13.2 Lb.  
• 40" (L) x 19" (W)

**SAVE \$10**

OEM TOOLS



36"  
SKU 1189084  
24977

**39<sup>99</sup>** REG. \$49.99  
• Light Weight 9 Lb.  
• 36" (L) x 18" (W)

**SAVE \$10**



### Professional 41" 6 Wheel Creeper

SKU 125749  
24970 **109<sup>99</sup>**

- 3D Streamline Design for Shoulder Clearance
- 6 Heavy Duty TPU Casters
- Low Ground Clearance Allows for Greater Mobility
- 4 Tool Storage Trays
- Weight Capacity: 300 Lb.



## Creepers

### Workshop Creeper Seat with 2 Drawers - Blue

SKU 542531  
24996 **89<sup>99</sup>**

- Padded Seat for Maximum Comfort
- 2 Sliding Drawers
- Can Holder for 3 Cans
- Smooth Rolling Wheels
- Weight Capacity: 280 Lb.



### ProGear Race Seat, Green/Black

SKU OUTSIDE BUY/EPO  
TRX2-705 **179<sup>99</sup>**

- Tray Spins for Easy Access to Tools and Parts
- Adjustable Seat Height: 13-1/2" to 17-1/2"
- Five Spoke Frame is OSHA Compliant



For Outside Buy/EPO, Call 901-300-4878

**NEW**

TRAXION  
engineered products

## Topside Creepers

### Topside Creeper

SKU OUTSIDE BUY/EPO  
TRX3-100

**379<sup>99</sup>**

- Height Adjusts from 48" to 64"
- Weight Capacity: 400 Lb.



For Outside Buy/EPO, Call 901-300-4878

### NXT Topside Creeper

SKU OUTSIDE BUY/EPO  
TRX3-200

**499<sup>99</sup>**

- Height Adjusts from 48" to 64"
- I-Base Design for More Flexible Positioning Around the Vehicle
- Weight Capacity: 400 Lb.



For Outside Buy/EPO, Call 901-300-4878

TRAXION  
engineered products

OEM TOOLS  
MADE FOR MECHANICS

# THE SPECIALTY TOOLS YOU NEED



See Specialty Tools on pages 34-40

## Workshop Stools

### Swivel Shop Stools

- Swivel Seat
- Double Foot Ring for Strength
- Seamless Pad
- 30.5" High x 14" Across

#### Black

SKU 512951  
24910

**79<sup>99</sup>**

#### Black (2 Pack)

SKU 432326  
24910TWO

**149<sup>99</sup>**



### Adjustable Height Stool

- Ideal for Shop or Garage Use
- Adjustable Height: 28" to 32-1/2"
- Durable, Vinyl-Padded Swivel Seat
- Backrest for Comfortable Support

#### Black

SKU 512945  
24911

**99<sup>99</sup>**

#### Black (2 Pack)

SKU 362969  
24911TWO

**149<sup>99</sup>**



#### Green (2 Pack)

SKU 758787  
24931TWO

**149<sup>99</sup>**



## Work Stand



### Pro Step Adjustable Work Stand

SKU 222856 **249<sup>99</sup>**  
STK20350

- 500 Lb. Capacity
- Height Adjustable from 6-1/2" to 22-1/2"
- 32" x 16"



## Truck Tire Step



### Truck Tire Step

SKU 418849 **49<sup>99</sup>**  
24913B

- Fits Both Front and Rear 9" to 13" Wide Tires
- Powder Coat Finish
- Designed for SUVs, Motor Homes and Light Duty Trucks
- Heavily Textured Non-Slip Step for Safety
- Adjustable Rubber Bumpers
- Protect Your Wheels and Ensure the Step is Sturdy and Level
- Easy to Adjust
- Weight Capacity: 300 Lb.



## Fender Covers



### Fender Cover

SKU 965832 **14<sup>99</sup>**  
24900

- Heavy Gauge Vinyl
- Wipes Clean
- 27" x 34"



### Soft Fleece Fender Cover

SKU 751711 **25<sup>99</sup>**  
24899

- Soft Fleece Fender Cover to Prevent Paint Damage
- 2 Super Powerful Corner Magnets for Securing the Cover in Place
- Magnets are Removable to Wash the Cover
- Large 42" x 24" Size for Cars, Trucks and SUVs



## Magnetic Nut Cups



### Multicolor Magnetic Nut Cup Assortment (4 Pack)

SKU 1282743 **29<sup>99</sup>**  
68939

- Holds Bolts, Nuts and Parts to Speed Up Work and Eliminate Misplacing Parts
- Coated Magnet Sticks to All Ferrous Metal Work Surfaces
- Includes:
  - 1 Green Cup
  - 1 Red Cup
  - 1 Orange Cup
  - 1 Blue Cup



Strong Magnets Attach the Cups Securely to Most Flat Metal Surfaces



Hang Hole

# SHOP SUPPLIES

## Hardware and Service Parts

### 96 Piece Mini Fuse Kit

SKU 271169 **19<sup>99</sup>**  
68148

- Includes: Mini Fuses 3A to 30A



### 96 Piece ATO Fuse Assortment

SKU 271172 **8<sup>99</sup>**  
68149

- Includes: ATO Fuses 3A to 30A



### 24 Piece Maxi Fuse Assortment

SKU 271152 **24<sup>99</sup>**  
68146

- Includes: Maxi Fuses 20A to 100A



### 200 Piece Spring Assortment

SKU 271195 **14<sup>99</sup>**  
68140

- Includes: 20 Popular Sizes from 7/32" x 11/16" to 5/16" x 1-1/4"



### Universal O-Ring Set

**407 Piece (SAE)**  
SKU 546661  
68168 **19<sup>99</sup>**

- Inside Diameters from 1/8" to 2"

**419 Piece (Metric)**  
SKU 546659  
68167 **19<sup>99</sup>**

- Inside Diameters from 3 mm to 50 mm

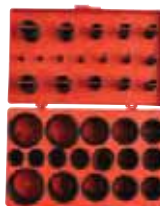

### 270 Piece A/C O-Ring Kit

SKU 271196 **17<sup>99</sup>**  
68141

- Contains 270 O-Rings in a Variety of SAE Sizes
- Great O-Ring Set for Most Automotive and Refrigerant Applications



### 110 Piece Copper Washer Assortment

SKU 271176 **17<sup>99</sup>**  
68117

- Includes: Popular Sizes M6 to M16



### 115 Piece Master Brake Line Fitting Assortment Kit

SKU 082943 **119<sup>99</sup>**  
DOWDY-BLF-5

- 23 Brake Line Fitting Variations
- Tube Nuts, Union, Brake Line Adapters



### 230 Piece Domestic Retainer Assortment Kit

SKU 082940 **64<sup>99</sup>**  
DOWDY-6000U

- 23 Retainer Variations
- For Doors, Trim and Shrouds



### 555 Piece Stainless Cotter Pin Assortment

SKU 271183 **17<sup>99</sup>**  
68121

- Includes: 6 Popular Sizes from 1/16" x 1" to 5/32" x 2-1/2"



### 500 Piece Aluminum Rivet Assortment

SKU 271150 **13<sup>99</sup>**  
68109

- Includes: 1/8" and 3/16" Rivets 1/4", 5/16" and 3/8" Long



### 80 Piece Vacuum Cap Assortment

SKU 271197 **12<sup>99</sup>**  
68129

- Includes Sizes: 3/16" to 3/8"



### 34 Piece Hose Clamp Assortment

SKU 271201 **14<sup>99</sup>**  
68137

- Includes Sizes: 5/8" to 1-1/4"



### 88 Piece Drain Plug and Gasket Assortment Kit

SKU 617724 **89<sup>99</sup>**  
DOWDY-DPA-6

- 18 Drain Plug Variations, 4 Gasket Variations
- Most Popular 12 mm and 14 mm Drain Plugs



### 240 Piece Master Drain Plug Gasket Assortment Kit

SKU 606762 **114<sup>99</sup>**  
DOWDY-DGK-240

- 24 Drain Plug Gasket Variations
- Aluminum, Copper, Crush, Fold-Over, Nylon, Rubber/Metal



### 120 Piece Oil Drain Plug Gasket Assortment

SKU 1400041 **29<sup>99</sup>**  
SURDPG120

- Covers Most Domestic and Import Cars and Light Trucks
- 120 Total: 24 Variations (5 each), Incl. Copper, Metal Crush, Nylon, Fiber and Rubber/Metal



### 76 Piece Oil Drain Plug Assortment

SKU 662839 **84<sup>99</sup>**  
SURDP454

- Includes: 76 Pieces with Corresponding Gaskets, 17 Direct Fit SKUs
- Includes: Labeled Case for Quick Identification and Organization
- Covers Most Domestic and Import Cars and Light Duty Trucks



### 60 Piece Wheel Lug Nut

- 12 Lug Nut Variations

**Assortment A**  
SKU 082947 **84<sup>99</sup>**  
DOWDY-WN-12

- Standard, Dome, Acorn Thread



### Assortment B

SKU 082948 **124<sup>99</sup>**  
DOWDY-WN-12B

- Dome Acorn, Bulge, Flat-Capped, External Thread



### Hanger Clamp Assortment

SKU 1284970 **64<sup>99</sup>**  
SURCL484

- Rubber Coating Reduces Chance of Corrosion and Other Damage
- Includes Clamp Sizes: 5/16", 1/4", 3/8", 1/2", 5/8" and 3/4"



Prices subject to change without notice. Prices do not include applicable taxes, vehicles, tires, rims, installation or optional equipment as shown. Please do not return purchases to the store. For information regarding warranty, repair, or any questions or concerns, call 901-300-4878.



# SAFETY & GLOVES

TO ORDER, contact your Commercial Sales Manager or go to [AutoZonePro.com](http://AutoZonePro.com)

SAFETY & GLOVES

## First Aid Kits

### First Aid Kits

- Meets ANSI Z308.1-2009 and OSHA Standards
- Contains Essential Supplies for Light Injuries and Wounds
- Wall Mountable Plastic Box

### 10-Person First Aid Kit

SKU 1442580 **32<sup>99</sup>**  
SAS6010-10

### 25-Person First Aid Kit

SKU 1442584 **47<sup>99</sup>**  
SAS6025-25

### 50-Person First Aid Kit

SKU 1442588 **54<sup>99</sup>**  
SAS6050-50



### 100-Person First Aid Kit

SKU 765585 **299<sup>99</sup>**  
SAS609901

- Meets OSHA 1910.151(b)
- Contains an Assortment of Supplies to Treat Small to Large Injuries
- Includes Dressings, Antiseptics, Burn Treatment Products and Personal Protective Devices
- Wall Mountable Metal Box

Safeguard Employees and Jobsites Through Injury Preparation with Multi-Functional First Aid Kits



## Safety Supplies

### Hi Vis Knit Beanie - Orange

SKU 687972 **11<sup>99</sup>**  
SAS692-1711

- One Size Fits All
- Comfortable and Warm
- 100% Knit Polyester
- ANSI/ISEA 107 Compliant
- Reflective Knit Stripe



### Hot Sleeve

SKU 291321 **24<sup>99</sup>**  
LIS18700

- Protects Arms from Burns While Working Around the Engine
- Made of Durable, Heat-Resistant Kevlar
- Double Wall Construction for Added Heat Protection



### Face Shield Clear

SKU 972271 **24<sup>99</sup>**  
SAS5140

- Impact-Resistant Polycarbonate Shield
- Curved Lens Design
- Ratcheting Headpiece
- Meets ANSI Z87.1-2015



## Ear Plugs

### Foam Ear Plugs

SKU 526953 **44<sup>99</sup>**  
SAS6100

- Noise Reduction Rating: 31
- 200 Individually Packaged Pairs
- Pre-Shaped Foam Earplugs



## Eyewash Stations

### Emergency 9 Gallon Eyewash Station Wall Mount Gravity Fed

SKU 912344 **309<sup>99</sup>**  
SAS5134-00

- Compliance - ANSI Z358.1-2014
- Portable Unit Measures 20.15" x 16.5" x 9.5"
- Includes: Mounting Bracket, Inspection Tag, Tamper Resistant Tie and Preservative



### Eyewash Concentrate Solution

SKU 1142715 **14<sup>99</sup>**  
SAS5136-01

- For Use with 9 Gallon Eyewash Station #SAS5134-00

### Bottle Eyewash Station

SKU 094904 **69<sup>99</sup>**  
SAS5132

- Includes: (2) 16 Oz. Eye Irrigate Solution Bottles Does Not Meet ANSI Z358.1



### 16 Oz. Eyewash Irrigate Refill

SKU 977588 **19<sup>99</sup>**  
SAS5130

- For Use with Eyewash Station SAS5132

## Back Belts

### Deluxe Back Support Belt

- Made of Lightweight, Cool, Washable Polyester
- 4 Plastic Stays for Flexible, Contoured Support
- Tapered Design Allows a Full Range of Body Motion While Maintaining Proper Support

**Small** SKU 803153 | SAS7161

**Large** SKU 803161 | SAS7163

**X-Large** SKU OSB/EPO | SAS7164

**XX-Large** SKU 803152 | SAS7165

**24<sup>99</sup> each**



## Sanitizing

### Air2 San Ozone Sanitizing System

SKU OUTSIDE BUY/EPO **999<sup>99</sup>**  
TEXG16050

- FDA Approved for Use
- Fully Automatic Sanitization Process
- O<sub>3</sub> to O<sub>2</sub> Reconversion at the End of the Procedure



For Outside Buy/EPO, Call 901-300-4878

For Outside Buy/EPO, Call 901-300-4878

Prices subject to change without notice. Prices do not include applicable taxes, vehicles, tires, rims, installation or optional equipment as shown. Please do not return purchases to the store. For information regarding warranty, repair, or any questions or concerns, call 901-300-4878.

# SAFETY & GLOVES

## Safety Glasses

### LED Safety Glasses

SKU 555987 **18<sup>99</sup>**  
26039

- High-Impact Resistant Lens Protects Eyes
- Flexible, Lightweight and Padded Frames
- Meets ANSI Z87.1
- Includes: (8) LR41 Batteries



### LED Safety Glasses (3 Pack)

SKU 592265 **14<sup>99</sup>**  
26017PK3

### NSX Turbo Safety Glasses

- High-Impact Polycarbonate Lens
- Safety Eyewear That Also Provides 99.9% UV Protection



### Smoke

SKU 462983 **29<sup>99</sup>**  
SAS5331PK

- Box of 12

- Scratch-Resistant Coating
- Single Lens Design
- Lightweight Wrap-Around Lens
- ANSI/ISEA Z87.1-2015 Compliant



### Clear

SKU 301767 **29<sup>99</sup>**  
SAS5330PK

- Box of 12



### Amber

SKU 462984 **29<sup>99</sup>**  
SAS5332PK

- Box of 12



**STORE STOCKED**

### Advantage X300 Series Safety Glasses - Amber (12 Pack)

SKU 1149164 **19<sup>99</sup>**  
JASS70711PK REG. \$34.99

- Lightweight, Comfortable and Affordable
- Lens Features an Anti-Scratch Hard Coating
- Made Using Virgin, Unitary Polycarbonate Lenses
- 99.9% UV Protection
- Ideal for Construction, Shop and General Eye Protection Applications



**SAVE \$15**



**JACKSON**

Offer Good Through March 31, 2025

## Multifocal Safety Reading Glasses

- Eye Protection and Multifocal Reading Glasses
- High Impact, Anti-Scratch Lenses Protect Your Eyes
- Fully Adjustable Temples for Comfort and Fit
- ANSI/ISEA Z87.1-2015 Compliant



**19<sup>99</sup> each**

**+1.5**  
SKU 752076  
26023

**+2.5**  
SKU 752078  
26025

**+2.0**  
SKU 752077  
26024

**+3.0**  
SKU 752086  
26026

Fully Adjustable Temples and Frame Provide a Custom Fit

## Detection Light

### UV Leak Detection Light and Glasses

SKU 213144 **19<sup>99</sup>**  
24516

- Compact UV Leak Detection Pen Light
- Yellow Lens Protective Glasses Enhance Visibility of Leaks
- Can Be Used with All Types of UV Leak Detection Dyes
- Includes: 2 AAA Batteries



2 AAA



## LOW PROFILE FLOOR JACKS



### 3 Ton Long/Low Signature Service Jack

SKU 1407611 **279<sup>99</sup>**  
24868

**3 3/8" LOW PROFILE**

**LONG REACH**

**PADDED HANDLE**



Dual Piston Hydraulic System for Quicker Lifting



Min. Height: 3-3/8"  
Max. Height: 24-1/4"

Length: 31-3/8"

Long Reach/Low Profile



Nylon Casters Protect Floor Surfaces

- Padded Jack Handle Helps Prevents Scratches and Dents to the Vehicle When Pumping Jack
- Overload and Bypass Safety Valves Prevent Use Over the Rated Capacity
- Industrial Strength Powder Coat Finish
- Precision-Welded Steel Construction
- Meets or Exceeds ASME PASE-2019 Safety Standard



### 2-1/2 Ton Aluminum/Steel Hybrid Floor Jack

SKU 1417557 **199<sup>99</sup>**  
24869

**3 1/2" LOW PROFILE**

**PADDED HANDLE**



Dual Piston Hydraulic System for Quicker Lifting



Low Profile

Max. Height: 19-1/4"  
Min. Height: 3-1/2"



Nylon Casters Protect Floor Surfaces

# SAFETY & GLOVES

TO ORDER, contact your Commercial Sales Manager or go to [AutoZonePro.com](http://AutoZonePro.com)

SAFETY & GLOVES

## Raven Gloves

### RAVEN

- 7 mil Powder-Free Latex-Free Nitrile
- Superior Puncture and Abrasion Resistance
- Ambidextrous Textured Grip
- Beaded Cuff



Find In Store,  
Right Now  
**19<sup>99</sup>** per box

STORE STOCKED

Medium SKU 435079 | 66517

Large SKU 244622 | 66518

XL SKU 244617 | 66519



### Buy More, Save More

2 Boxes of 100 Each **37<sup>99</sup>**  
~~19.00~~ per box

Medium SKU 547964 | SAS66517-2PK

Large SKU 547965 | SAS66518-2PK

XL SKU 547966 | SAS66519-2PK

XXL SKU 547963 | SAS66520-2PK

5 Boxes of 100 Each **89<sup>99</sup>**  
~~18.00~~ per box

Medium SKU 1189346 | SAS66517-5PK

Large SKU 1189328 | SAS66518-5PK

XL SKU 1189339 | SAS66519-5PK

XXL SKU 1442587 | SAS66520-5PK

10 Boxes of 100 Each **169<sup>99</sup>**  
~~17.00~~ per box

Medium SKU 1190191 | SAS66517CS

Large SKU 265052 | SAS66518CS

XL SKU 265053 | SAS66519CS

XXL SKU 1330682 | SAS66520CS

## Astro-Grip Gloves

### ASTRO-GRIP

- 7 mil Powder-Free Exam Grade Nitrile
- Exceptional Chemical and Puncture Resistance
- New Embossed Cube Grip



Find In Store,  
Right Now  
**24<sup>99</sup>** per box

STORE STOCKED

Medium SKU 823166 | 66472

Large SKU 823167 | 66473

XL SKU 823168 | 66474



### Buy More, Save More

2 Boxes of 100 Each **47<sup>99</sup>**  
~~24.00~~ per box

Medium SKU 1330679 | SAS66472-2PK

Large SKU 1330676 | SAS66473-2PK

XL SKU 1331500 | SAS66474-2PK

2XL SKU 1331496 | SAS66475-2PK

5 Boxes of 100 Each **114<sup>99</sup>**  
~~23.00~~ per box

Medium SKU 1330686 | SAS66472-5PK

Large SKU 1331480 | SAS66473-5PK

XL SKU 1331488 | SAS66474-5PK

2XL SKU 1331487 | SAS66475-5PK

10 Boxes of 100 Each **219<sup>99</sup>**  
~~22.00~~ per box

Medium SKU 1330697 | SAS66472CS

Large SKU 1331497 | SAS66473CS

XL SKU 1331489 | SAS66474CS

2XL SKU 1331494 | SAS66475CS

## Derma-Tuff Gloves

### DERMA-TUFF

**20% MORE GLOVES\***  
120/BOX

- Powder-Free Exam Grade Nitrile, 6 mil
- Textured for Enhanced Grip
- Outstanding Strength, Wear and Dexterity



\* Compared to 100 Count Box

2 Boxes of 120 Each **28<sup>99</sup>**  
~~14.49~~ per box

Large SKU 1189330 | SAS66583-2PK

XL SKU 1189352 | SAS66584-2PK

5 Boxes of 120 Each **71<sup>99</sup>**  
~~14.39~~ per box

Large SKU 1189350 | SAS66583-5PK

XL SKU 1189331 | SAS66584-5PK

10 Boxes of 120 Each **139<sup>99</sup>**  
~~13.99~~ per box

Large SKU 1189326 | SAS66583CS

XL SKU 1189347 | SAS66584CS



## Glove Dispenser

### Magnetic Glove Dispenser

SKU 765562 **19<sup>99</sup>**  
24945

- Attaches to Any Magnetic Surface for Convenient Glove Storage
- Self-Adjusting Spring Sides Hold Various Box Sizes
- 4 Powerful Magnets Provide 8 Lb. Load Capacity

OEM TOOLS



Supplies and Gloves Not Included



## MX Pro

- Excellent Dexterity and Flexibility for Intricate Work
- Outstanding Gripping Power
- Great Protection Against Blisters, Cuts and Abrasions
- Stretch Top for Great Flexibility and Ease of Movement
- Hook-and-Loop Closure
- Machine Washable



**16<sup>99</sup>** each

Large SKU 1142346 | SAS6653

XL SKU 1368618 | SAS6654

XXL SKU 1142418 | SAS6655

## Nitrile Palm Knit Glove

- 1 Box of 12 Each
- Liquid Dipped 100% Nitrile Palm Coat
- 16 Gauge Seamless Nylon Shell
- Knit Back Helps Keep Hands Cooler Longer



**34<sup>99</sup>** each

Large SKU 250887 | SAS6401909

XL SKU 250888 | SAS6401910

XXL SKU 250890 | SAS6401911

Prices subject to change without notice. Prices do not include applicable taxes, vehicles, tires, rims, installation or optional equipment as shown. Please do not return purchases to the store. For information regarding warranty, repair, or any questions or concerns, call 901-300-4878.

AZG0125

147



**FREE SHIPPING**  
WITH MOST ORDERS  
SEE PAGE 2 FOR DETAILS

**2025**  
**JAN-MAR**

Hablamos Español **Call 901-300-4878**

## GREAT FINANCING PROGRAMS\*

**UNISOURCE** 800-404-6792 | **NEWLANE** 267-768-3228 | **PEAC** 856-505-4450 | **LCA** 248-743-5125

### 1 LEASING COMPANIES

- Leases are handled by four companies
- Customer must:
  - Select equipment
  - Complete credit application
  - Receive approval from leasing company
- Once the transaction is approved and documents are signed by customer:
  - Customer invoice is funded by leasing company
  - Equipment order is placed



### 2 30-60-90

- AutoZone® credit account in existence for 6 months
- Satisfactory payment history with AutoZone®
- Updated account application with agreement section completed and signed
- No NSF checks within 6 months
- No credit holds within 6 months
- Established credit worthiness
- Minimum down payment = 35%
- Minimum 52 wks. sales = \$15 K
- Minimum equipment cost = \$1 K (sales tax included)

### 3 EXTENDED TERMS

- AutoZone® credit account in existence for 1 year
- Satisfactory payment history with AutoZone®
- Updated account application with agreement section completed and signed
- No NSF checks within 6 months
- Established credit worthiness
- Minimum down payment = 35%
- Minimum 52 wks. sales = \$25 K
- Minimum equipment cost by term:
  - 6 months \$3 K
  - 9 months \$6 K
  - 12 months \$8 K or greater (financial statement may be required)

\* Financing is provided by third parties who are not affiliates of AutoZone. All of the advertised loan programs, rates, terms and conditions are subject to change at any time without notice. An extra charge may be imposed at the end of the lease depending on the residual value of the leased goods. Free overnight shipping available to continental U.S. for qualifying VDP orders of 70 lb. or less. Free overnight shipping excludes: liftgate fees, residential delivery, non-network carriers, and certain freight intensive items that are shipped FOB.

©2025 GreatNeckTools, Inc. Certain content provided by and is the property of AutoZone Parts, Inc. All rights reserved. AutoZone, AutoZone & Design, Loan A Tool, Duralast, Duralast Gold, Duralast Proven Tough and Duralast ProPower are registered marks of AutoZone IP LLC or one of its affiliates. All other marks are the property of their respective holders. iPhone® and iPad® are registered trademarks of Apple Inc., Android® is a trademark of Google Inc., STP® is a registered trademark of the Energizer Auto, Inc., and Bluetooth® is a trademark of Bluetooth® SIG, Inc. Items requiring freight shipping cannot be delivered outside of the continental United States. For shipping cost to Alaska or Hawaii, please contact Commercial Sales Manager. Ad prices cannot be combined with any other offer. Offers may vary by market. Offers valid while quantities last. Items may not be available at all locations at all times. We reserve the right to limit quantities and to correct pricing errors. Some new items might not be available at the time of print deadline. Prices valid only during sales catalog effective dates. All photographic, clerical, typographical and printing errors are subject to correction. Images shown may not be actual product but represent products or sets which include product. We reserve the right to substitute a like item or an item of greater value on any promotional offer in this publication. Store stock items may be purchased at any local AutoZone store or through your AutoZone Commercial Sales Manager. Bonus items are fulfilled while supplies last and may ship separately. Bonus items may be replaced with like items of the same or greater value.